

Manual for Starch Gel Electrophoresis: A Method for the Detection of Genetic Variation

Paul B. Aebersold, Gary A. Winans, David J. Teel, George B. Milner, and Fred M. Utter

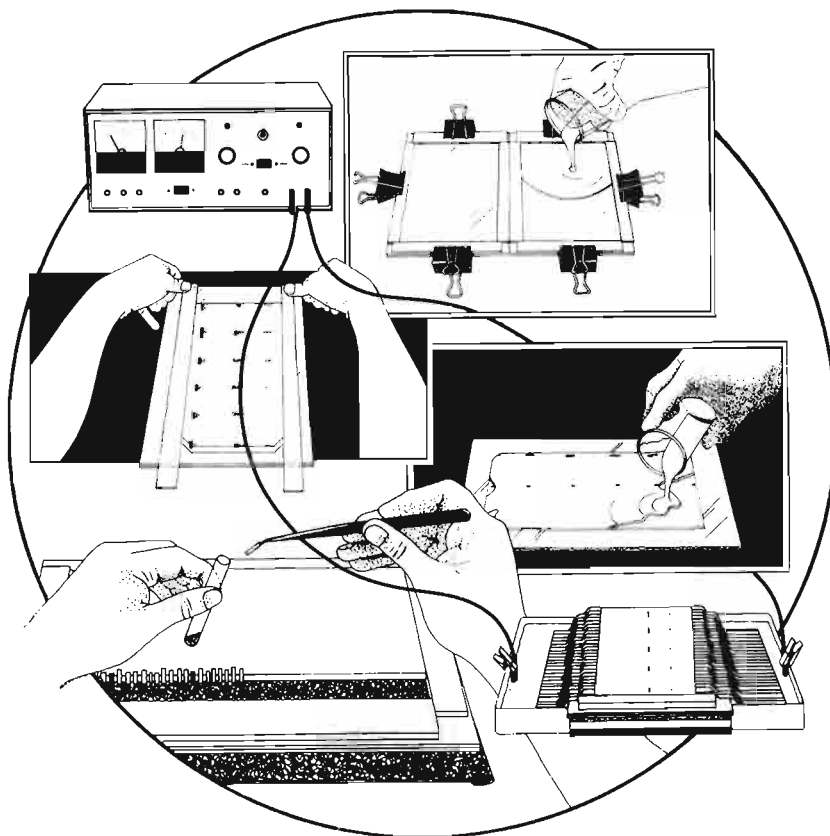

U.S. DEPARTMENT OF COMMERCE
National Oceanic and Atmospheric Administration
National Marine Fisheries Service

NOAA TECHNICAL REPORT NMFS

The major responsibilities of the National Marine Fisheries Service (NMFS) are to monitor and assess the abundance and geographic distribution of fishery resources, to understand and predict fluctuations in the quantity and distribution of these resources, and to establish levels for their optimum use. NMFS is also charged with the development and implementation of policies for managing national fishing grounds, development and enforcement of domestic fisheries regulations, surveillance of foreign fishing off United States coastal waters, and the development and enforcement of international fishery agreements and policies. NMFS also assists the fishing industry through marketing service and economic analysis programs, and mortgage insurance and vessel construction subsidies. It collects, analyzes, and publishes statistics on various phases of the industry.

The NOAA Technical Report NMFS series was established in 1983 to replace two subcategories of the Technical Reports series: "Special Scientific Report—Fisheries" and "Circular." The series contains the following types of reports: Scientific investigations that document long-term continuing programs of NMFS; intensive scientific reports on studies of restricted scope; papers on applied fishery problems; technical reports of general interest intended to aid conservation and management; reports that review in considerable detail and at a high technical level certain broad areas of research; and technical papers originating in economics studies and from management investigations. Since this is a formal series, all submitted papers receive peer review and those accepted receive professional editing before publication.

Copies of NOAA Technical Reports NMFS are available free in limited numbers to governmental agencies, both Federal and State. They are also available in exchange for other scientific and technical publications in the marine sciences. Individual copies may be obtained from: U.S. Department of Commerce, National Technical Information Service, 5285 Port Royal Road, Springfield, VA 22161. Although the contents have not been copyrighted and may be reprinted entirely, reference to source is appreciated.

13. Guidelines for reducing porpoise mortality in tuna purse seining, by James M. Coe, David B. Holts, and Richard W. Butler. September 1984, 16 p.
14. Synopsis of biological data on shortnose sturgeon, *Acipenser brevirostrum* LeSueur 1818, by Michael J. Dadswell, Bruce D. Taubert, Thomas S. Squires, Donald Marchette, and Jack Buckley. October 1984, 45 p.
15. Chaetognatha of the Caribbean sea and adjacent areas, by Harding B. Michel. October 1984, 33 p.
16. Proceedings of the Ninth and Tenth U.S.-Japan Meetings on Aquaculture, by Carl J. Sindermann (editor). November 1984, 92 p.
17. Identification and estimation of size from the beaks of 18 species of cephalopods from the Pacific Ocean, by Gary A. Wolff. November 1984, 50 p.
18. A temporal and spatial study of invertebrate communities associated with hard-bottom habitats in the South Atlantic Bight, by E. L. Wenner, P. Hinde, D. M. Knott, and R. F. Van Dolah. November 1984, 104 p.
19. Synopsis of biological data on spottail pinfish, *Diplodus holbrookii* (Pisces: Sparidae), by George H. Darcy. January 1985, 11 p.
20. Ichthyoplankton of the Continental Shelf near Kodiak Island, Alaska, by Arthur W. Kendall, Jr., and Jean R. Dunn. January 1985, 89 p.
21. Annotated bibliography on hypoxia and its effects on marine life, with emphasis on the Gulf of Mexico, by Maurice L. Renaud. February 1985, 9 p.
22. Congrid eels of the eastern Pacific and key to their Leptocephali, by Solomon N. Raju. February 1985, 19 p.
23. Synopsis of biological data on the pinfish, *Lagodon rhomboides* (Pisces: Sparidae), by George H. Darcy. February 1985, 32 p.
24. Temperature conditions in the cold pool 1977-81: A comparison between southern New England and New York transects, by Steven K. Cook. February 1985, 22 p.
25. Parasitology and pathology of marine organisms of the world ocean, by William J. Hargis, Jr. (editor). March 1985, 135 p.
26. Synopsis of biological data on the sand perch, *Diplectrum formosum* (Pisces: Serranidae), by George H. Darcy. March 1985, 21 p.
27. Proceedings of the Eleventh U.S.-Japan Meeting on Aquaculture, Salmon Enhancement, Tokyo, Japan, October 19-20, 1982, by Carl J. Sindermann (editor). March 1985, 102 p.
28. Review of geographical stocks of tropical dolphins (*Stenella* spp. and *Delphinus delphis*) in the eastern Pacific, by William F. Perrin, Michael D. Scott, G. Jay Walker, and Virginia L. Cass. March 1985, 28 p.
29. Prevalence, intensity, longevity, and persistence of *Anisakis* sp. larvae and *Lacisitorhynchus tenuis* metacestodes in San Francisco striped bass, by Mike Moser, Judy A. Sakanari, Carol A. Reilly, and Jeannette Whipple. April 1985, 4 p.
30. Synopsis of biological data on the pink shrimp, *Pandalus borealis* Krøyer, 1838, by Sandra E. Shumway, Herbert C. Perkins, Daniel F. Schick, and Alden P. Stickney. May 1985, 57 p.
31. Shark catches from selected fisheries off the U.S. east coast, by Emory D. Anderson, John G. Casey, John J. Hoey, and W. N. Witzell. July 1985, 22 p.
32. Nutrient Distributions for Georges Bank and adjacent waters in 1979, by A. F. J. Draxler, A. Matte, R. Waldhauer, and J. E. O'Reilly. July 1985, 34 p.
33. Marine flora and fauna of the Northeastern United States. Echinodermata: Echinoidea, by D. Keith Serafy and F. Julian Fell. September 1985, 27 p.
34. Additions to a revision of the shark genus *Carcharhinus*: Synonymy of *Aprionodon* and *Hypoprion*, and description of a new species of *Carcharhinus* (Carcharhinidae), by J. A. F. Garrick. November 1985, 26 p.
35. Synoptic review of the literature on the Southern oyster drill *Thais haemastoma floridana*, by Philip A. Butler. November 1985, 9 p.
36. An egg production method for estimating spawning biomass of pelagic fish: Application to the northern anchovy, *Engraulis mordax*, by Reuben Lasker (editor). December 1985, 99 p.
37. A histopathologic evaluation of gross lesions excised from commercially important North Atlantic marine fishes, by Robert A. Murchelano, Linda Despres-Patanjo, and John Ziskowski. March 1986, 14 p.
38. Fishery atlas of the northwestern Hawaiian Islands, by Richard N. Uchida and James H. Uchiyama (editors). September 1986, 142 p.
39. Survey of fish protective facilities at water withdrawal sites on the Snake and Columbia Rivers, by George A. Swan, Tommy G. Withrow, and Donn L. Park. April 1986, 34 p.
40. Potential impact of ocean thermal energy conversion (OTEC) on fisheries, by Edward P. Myers, Donald E. Hoss, Walter M. Matsumoto, David S. Peters, Michael P. Seki, Richard N. Uchida, John D. Ditmars, and Robert A. Paddock. June 1986, 33 p.
41. A stationary visual census technique for quantitatively assessing community structure of coral reef fishes, by James A. Bohnsack and Scott P. Bannerot. July 1986, 15 p.
42. Effects of temperature on the biology of the northern shrimp, *Pandalus borealis*, in the Gulf of Maine, by Spencer Apollonio, David K. Stevenson, and Earl E. Dunton, Jr. September 1986, 22 p.
43. Environment and resources of seamounts in the North Pacific, by Richard N. Uchida, Sigeiti Hayasi, and George W. Boehlert (editors). September 1986, 105 p.
44. Synopsis of biological data on the porgies, *Calamus arctifrons* and *C. proridens* (Pisces: Sparidae), by George H. Darcy. September 1986, 19 p.
45. Meristic variation in *Sebastes* (Scorpaenidae), with an analysis of character association and bilateral pattern and their significance in species separation, by Lo-chai Chen. September 1986, 17 p.
46. Distribution and relative abundance of pelagic nonsalmonid nekton off Oregon and Washington 1979-84, by Richard D. Brodeur and William G. Pearcy. December 1986, 85 p.

NOAA Technical Report NMFS 61

Manual for Starch Gel
Electrophoresis:
A Method for the Detection
of Genetic Variation

Paul B. Aebersold, Gary A. Winans, David J. Teel,
George B. Milner, and Fred M. Utter

December 1987



U.S. DEPARTMENT OF COMMERCE
C. William Verity, Jr., Secretary
National Oceanic and Atmospheric Administration
Anthony J. Calio, Administrator
National Marine Fisheries Service
William E. Evans, Assistant Administrator for Fisheries

The National Marine Fisheries Service (NMFS) does not approve, recommend or endorse any proprietary product or proprietary material mentioned in this publication. No reference shall be made to NMFS, or to this publication furnished by NMFS, in any advertising or sales promotion which would indicate or imply that NMFS approves, recommends or endorses any proprietary product or proprietary material mentioned herein, or which has as its purpose an intent to cause directly or indirectly the advertised product to be used or purchased because of this NMFS publication.

CONTENTS

Introduction 1

Collection and storage of specimens 1

Preparation of tissues 3

Preparation of a starch gel 4

Application of enzyme extracts to a gel 6

Setting up a gel for electrophoresis 7

Slicing a gel 8

Staining a gel 9

Acknowledgments 10

Citations 10

Appendices

1 Staining recipes 11

2 Electrophoresis buffers 20

Manual for Starch Gel Electrophoresis: a Method for the Detection of Genetic Variation

PAUL B. AEBERSOLD
GARY A. WINANS
DAVID J. TEEL
GEORGE B. MILNER
FRED M. UTTER

*Coastal Zone and Estuarine Studies Division
Northwest and Alaska Fisheries Center
National Marine Fisheries Service, NOAA
2725 Montlake Boulevard East
Seattle, Washington 98112*

ABSTRACT

The procedure to conduct horizontal starch gel electrophoresis on enzymes is described in detail. Areas covered are (1) collection and storage of specimens, (2) preparation of tissues, (3) preparation of a starch gel, (4) application of enzyme extracts to a gel, (5) setting up a gel for electrophoresis, (6) slicing a gel, and (7) staining a gel. Recipes are also included for 47 enzyme stains and 3 selected gel buffers.

Introduction

Electrophoresis is the most useful technique yet devised for studying genetic variability within and among populations of plants and animals (Avisé 1974; Ayala 1976; Hartl 1980). In fact, over 1,200 species have been studied electrophoretically in basic and applied research (see references in Nevo et al. 1984). Since 1966, geneticists at the Northwest and Alaska Fisheries Center, National Marine Fisheries Service, NOAA, Seattle, Washington, have been using starch gel electrophoresis of proteins (or, more specifically, enzymes) to investigate population genetics of numerous aquatic organisms, particularly fishes.

Electrophoresis is the separation of a mixture of electrically charged molecules in an electric field. When a molecular mixture is placed in an electric field, the molecules with a net electrical charge will be attracted to the opposite side of the electric field (positive molecules to the negative side and negative molecules to the positive side) at a rate dependent on the amount of their charge (and to some extent on their size). Therefore, all like-charged molecules will migrate a characteristic distance through the electric field in a given time. When a mixture is applied in the field, the result is an isolation of each molecular charge-type at varying distances from their point of application.

The purpose of this report is to thoroughly describe procedures currently used in our laboratory for horizontal starch gel electrophoresis. It is intended as a complement to other descriptions that may be outdated or abbreviated (Smith 1968; Brewer and Sing 1970; Utter et al. 1974; Harris and Hopkinson 1976; Siciliano and Shaw 1976; May et al. 1979; Shaklee and Keenan 1986). The procedures we describe have been adopted more from personal experience and convenience than from necessity. Thus, other laboratories may effectively employ procedures that differ from ours. The general areas and procedures we cover, however, are common to all users. Despite specific procedural differences, they yield the same result. The areas we discuss in detail are (1) collection and storage of specimens, (2) preparation of tissues, (3) preparation of a starch gel, (4) application of enzyme extracts to a gel, (5) setting up a gel for electrophoresis, (6) slicing a gel, and (7) staining a gel (Fig. 1). Recipes for 47 enzyme stains (Appendix 1) and 3 gel buffers (Appendix 2) are included. We believe that this information will be generally useful as a working manual because electrophoretic investigations of all classes of organisms are related by similar biological constraints (e.g., heat-labile enzymes) and mechanical processes involved in separating proteins in a gel matrix. In addition, the thoroughness with which we have covered these procedures will be particularly useful for people attempting starch gel electrophoresis for the first time.

Collection and storage of specimens

Procedures for the collection and storage of specimens for electrophoresis are extremely important because of the lability of enzymes *in vitro*. Proper cryogenic storage will preserve enzyme activity and minimize breakdown. Conversely, improper collection and preservation commonly result in a reduction or loss of enzyme activity or in uninterpretable electrophoretic patterns due to enzyme breakdown. Thus, the ultimate success of an electrophoretic project rests initially on the proper collection and preservation of specimens. Although the procedures described here are for fish specimens, the processes are generally applicable to other organisms.

1 Collection and storage of specimens

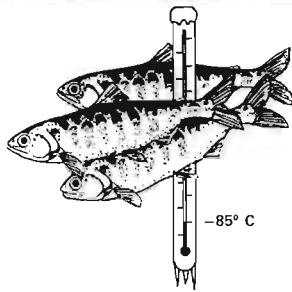

2 Preparation of tissues

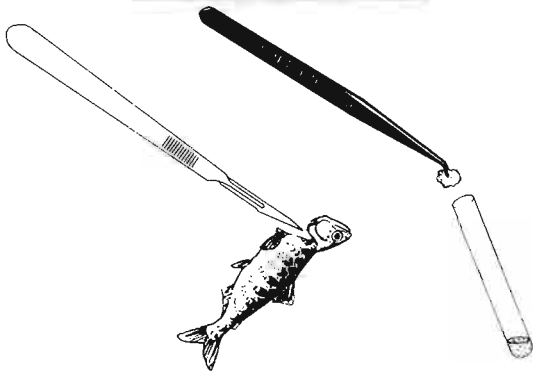

3 Preparation of a starch gel

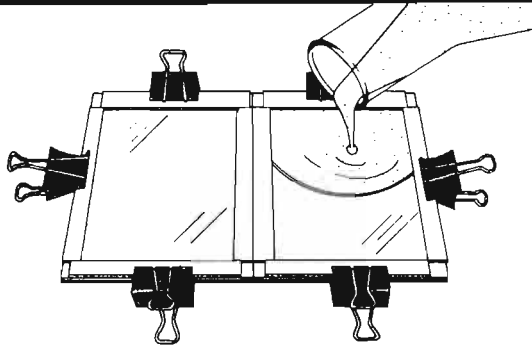

4 Application of enzyme extracts to a gel

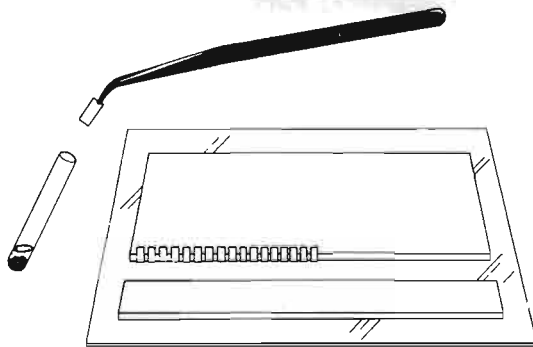

5 Setting up a gel for electrophoresis

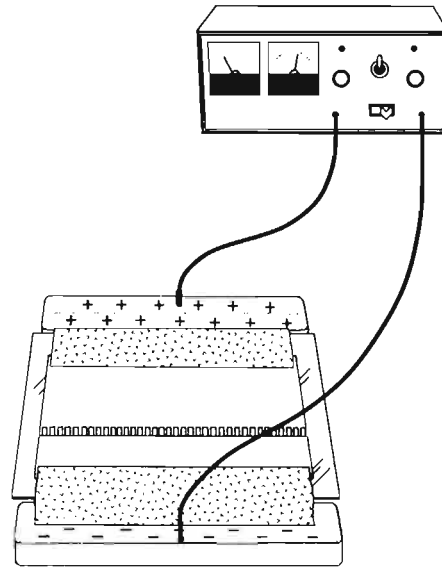

6 Slicing a gel

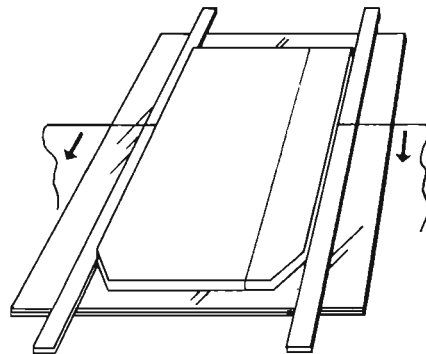

7 Staining a gel

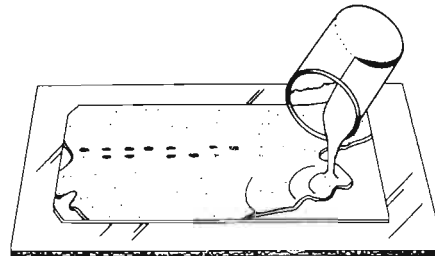

Figure 1
Diagram of the seven steps involved in the electrophoretic method.

When fish are sacrificed for analysis, enzyme degradation begins almost immediately. The rate of degradation is enzyme-specific. Packing the specimens in ice will slow the degradation process only slightly. Freezing the samples at normal freezer temperatures (-10°C to -20°C) will reduce degradation considerably. However, even at these temperatures, if electrophoresis is not conducted within a few weeks, enzyme degradation will become apparent. At the temperature of dry ice (-76°C) or colder, the stability of the enzymes is greatly improved. Enzyme activity in tissues immediately frozen with dry ice and stored for up to 6 mo at -85°C in an ultracold freezer is comparable to enzyme activity in tissues from freshly sacrificed specimens. In fact, we have achieved satisfactory results with specimens collected on dry ice and stored at -85°C for greater than 2 yr. Thus, for the best electrophoretic results, we recommend that specimens or tissues of specimens be (1) frozen with dry ice immediately after collection, (2) transported with dry ice to an electrophoresis laboratory, and (3) stored at -85°C until used.

The quantity of dry ice needed while collecting in the field depends upon many factors. These include the quality and size of the cooler in which the samples are held, volume of specimens being collected, number of times the cooler will be opened prior to returning to the laboratory, length of time spent in the field and in transport, and ambient air temperature. For example, we would use a minimum of 2.3 kg (5 lb) of dry ice in a 7.6-L (8 qt) cooler to collect 100 juvenile fish on a 24°C (80°F) day, with a total time of 8 h spent going to the sample location, collecting the specimens, and returning to the laboratory. To collect tissues from 100 adults under the same circumstances would require a 38-L (40 qt) cooler and a minimum of 9.0 kg (20 lb) of dry ice. Reducing the air space in the cooler makes dry ice more effective and longer lasting. Also, when sufficient dry ice is available, it is placed above and below the specimens; otherwise, the dry ice is placed above the specimens in the cooler. Specimens are kept in a cooler with sufficient quantities of dry ice until they can be stored in a -85°C freezer.

Whole specimens or tissue samples are prepared for cryogenic storage in a way that minimizes the amount of time necessary to prepare them for electrophoresis. For example, it is undesirable to freeze fish in a ball with water. Fish prepared in this fashion require considerable thawing time to separate them for dissection, and, therefore, they are more prone to enzyme degradation.

We recommend that whole fish be prepared for freezing in the following manner which allows for easy separation prior to dissection. Fish with a fork length of 20 cm or less (five or more fish per pound) are collected and frozen whole. Of these fish, those that are 6-20 cm long (between 5 and 160 fish per pound) are rolled up dry in bundles of 10 to 20 specimens using sheets of polyethylene film or "plastic wrap." To do this, specimens are briefly blotted to remove excess moisture. Two or three specimens are spread out near one end of the plastic wrap, which is then folded over the specimens. Then, several more specimens are laid down, rolled into the bundle, and so on. This method keeps the fish separated by plastic film and facilitates separating them later for dissection. Fish smaller than 6 cm fork length (160 or more fish per pound) are loosely placed in a single layer into a sealable or "zip-lock" bag (10×10 cm) without water.

For specimens greater than 20 cm fork length (five or fewer fish per pound), we usually dissect out the desired tissues at the time of collection and freeze the set of tissues from each specimen in one zip-lock bag (10×10 cm). We routinely analyze enzymes from four sources: skeletal muscle, heart, liver, and retinal tissue and vitreous fluid from the eye. For the first three tissues, a cube of

tissue measuring approximately 3 cm^3 or weighing 20 g is taken from the fish when possible. For the retinal tissue and vitreous fluid, both eyes are removed and stored whole. Care is taken to avoid prolonged exposure of the tissue to direct sunlight. Each bag of specimens from a location is labeled with information regarding species name, date of collection, sample location, and number of specimens. Labels are written in large bold print on water-resistant paper and inserted in each bag so that they are visible from the outside of the plastic bag. Alternatively, a tag on a piece of wire can be used for this information as well as to secure the bag.

Preparation of tissues

Once specimens or tissue samples have been obtained and stored properly, an enzyme extract of each tissue is prepared for each specimen. To do this, specimens are removed from the freezer and allowed to thaw for about 10 to 20 min, just until the tissues can be cut. When preparing subsamples of extracted tissues from adult fish, approximately 0.75 g or 7 mm^3 are cut from each tissue. To subsample frozen eyes, one-fourth to one-third of the eyeball is cut away and the frozen vitreous fluid with the surrounding black retinal tissue is collected. Each of these subsamples is placed into a culture tube (12×75 mm, disposable) containing a tissue dilution buffer. This is done for each tissue of each fish, being careful to ensure the subsamples are not contaminated with other tissues. Our tissue dilution buffer (abbreviated PTP buffer)¹ consists of PIPES [Piperazine-N,N'-bis(2-ethanesulfonic acid)], Triton X-100, and pyridoxal-5-phosphate. The volume of buffer added to each tube depends upon the number of gels required for each specimen as well as the amount and type of tissue being diluted. Usually about 0.2 to 0.4 ml of PTP buffer is added per culture tube. Muscle tissues are usually given 0.05 mL more dilution buffer per sample than liver or heart tissues because muscle tissues tend to absorb the buffer. Because of their initial liquid state, eye fluid samples from salmonids are usually given one-half the volume of the liver or heart tissues. We have observed that the vitreous fluid from marine fish, however, is much more viscous than that of salmonids and requires more dilution, 0.1 mL less than liver or heart tissues.

We routinely prepare tissues from 5 to 10 frozen specimens at a time. The culture tubes are kept in a tube rack which is in an icewater bath to keep the samples as cold as possible during the preparation process. When the group of 5 to 10 specimens is completed, the tubes are transferred into other tube racks, one appropriately labeled rack for each tissue, and put into a freezer. A specimen number, corresponding with the subsample position in the culture tube rack, is added to each specimen bag in the event resampling might be necessary. Upon completion of subsampling, the racks of culture tubes are individually enclosed in plastic bags, secured with rubber bands, and moved to a -85°C freezer until the tissues are analyzed. We do not routinely homogenize tissues prior to electrophoresis. Instead, we rely on a freeze-thaw process during subsample preparation and application to the starch gel for cell disruption and enzyme extraction (see Aebersold et al. 1986). However, tissues which will be used fresh or without extended freezing should be homogenized in some fashion.

¹The PTP buffer consists of 0.05M PIPES, 0.05% Triton X-100, and 0.2 mM pyridoxal-5-phosphate adjusted to a final pH of 6.8 with 1.0 M NaOH. PIPES will not go into solution at the initial acidic pH until an approximate pH of 5.5 is approached with the NaOH. After that, the Triton X-100 and pyridoxal-5-phosphate are added before the final pH adjustment is made (Aebersold et al. 1986).

The preparation of whole juvenile fish for electrophoresis is similar to the preparation of extracted adult tissues. However, dissection and extraction of the tissues involve a more delicate procedure. Quite often the entire liver, heart, and one or both eyeballs are taken from juvenile fish. In such cases, the heart should be chopped up with a scalpel (to open the tough membrane surrounding the heart) before insertion into the culture tube, and eyeballs should be broken open in the tube by smashing them with a glass rod. Also, the amount of dilution buffer should be reduced in proportion to the reduction in tissue volume.

Preparation of a starch gel

In the electrophoretic procedures described here, enzymes are separated in an electric field relative to their electrical charge to reveal possible genetic differences. The medium we use for the electric field to separate the enzymes is a starch gel. A gel is made in a Plexiglas/glass mold into which hot starch solution is poured and allowed to gel upon cooling.

The gel mold consists of a glass plate on the bottom and four Plexiglas strips clamped around the edges (Fig. 2). We use laminated glass to eliminate stress fracturing that may occur when the hot gel solution is poured into the mold. Dimensions of glass plates and Plexiglas strips are given in Table 1. The thickness of the strips can be varied to make thicker or thinner gels as needed. The strips are held in position on the glass plate with paper clamps. The mold is elevated above the lab counter to leave clearance for the clamps and accelerate cooling. To save time and counter space, a number of gel molds can be set up together by butting the gel molds up to one another before clamping, as in Figure 2. Gel molds should be set up on a level surface. The type of buffer used to make the gel is written with wax pencil on one of the short plastic strips for each mold.

The gels are made by mixing a heated buffer with hydrolyzed potato starch (Sigma Chemical Co., St. Louis, MO). In this proce-

cedure, the first step is to weigh the starch and put into a wide-mouth Erlenmeyer flask. For one to two gels, a 1-L flask works well; up to four gels can be poured from a 2-L flask. We usually make a 12% starch gel, with a 6-mm thick gel mold holding 300 mL of starch solution. Therefore, to make one gel, 36 g of starch are weighed and added to the flask.

The buffer used to prepare the gel can vary considerably in composition, concentration, and pH, each having an effect on the mobility, resolution, and activity of each enzyme. Many buffer recipes are available for these purposes. A number of these recipes can be found in the references previously cited in the Introduction. We use three buffers (or slight variations of these) in resolving a majority of the enzymes in our studies. These buffers are given in Appendix 2.

Each buffer is made as a concentrated stock solution and diluted as stated to make the gel. After dilution, one-third of the volume (100 mL of the 300 mL used for one gel) goes in the flask with the starch, and the flask is immediately swirled to fully suspend all the starch. (If a wet flask is used for the starch, the buffer should be added immediately after adding the starch to reduce the chance of creating lumps.) The remainder of the buffer is put into an appropriate-sized volumetric or narrow-mouth Erlenmeyer flask.

The flask containing only the buffer is heated. When the buffer begins to boil, the flask is first swirled to settle the boiling action, which could cause the buffer to splatter out when dispensing. Then the buffer is rapidly poured into the flask with the starch-buffer mixture, with simultaneous swirling of both flasks. It is important to swirl the flask with the starch just prior to addition of the hot buffer to ensure that the starch is fully suspended to achieve a smooth lump-free gel. At this point, the starch mixture is a thick paste. Additional heating is needed to raise the temperature of the solution to the boiling point. This is necessary to achieve the proper viscosity for aspiration and pouring. Proper viscosity is indicated when the size of the bubbles changes from large to small and the bubbles rise up to the surface of the starch solution. The

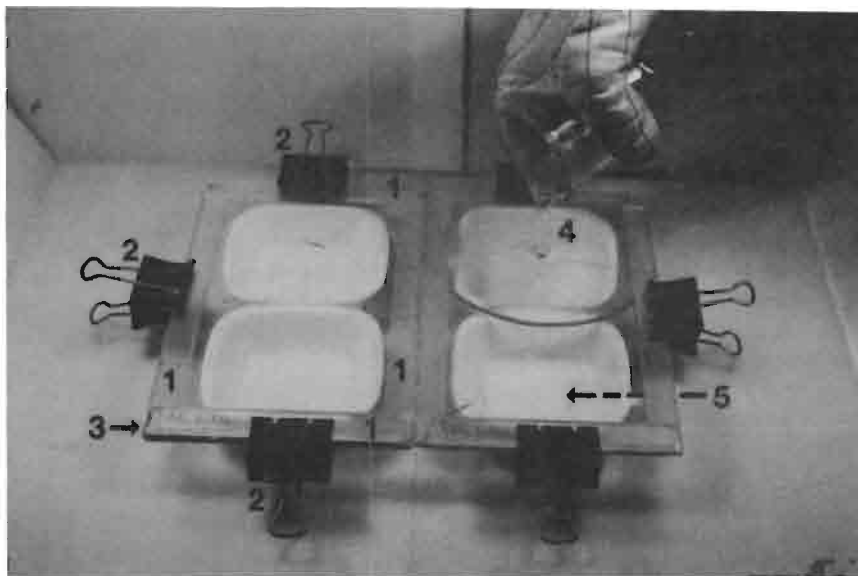

Figure 2

Gel molds. Four Plexiglas strips (1) are held with clamps (2) around each glass plate (3) to form a gel mold. Hot liquid starch (4) is then poured into the mold as illustrated. The glass plates are elevated off the counter on polystyrene cups (5) to leave room for the clamps.

Items	Length -----	Width (mm)	Thickness -----
For gel molds			
glass plate	267	165	5.7
short Plexiglas strip	165	19	6*
long Plexiglas strip	229	19	6*
For slicing gels			
glass plate	280	152	5
Plexiglas strip	305	19	1*
Blue Ice package	254	165	30
Cooling plate	267	165	25
Sponge cloths	235	127	—

*Strips twice as thick can be used depending upon the number of gel slabs required.

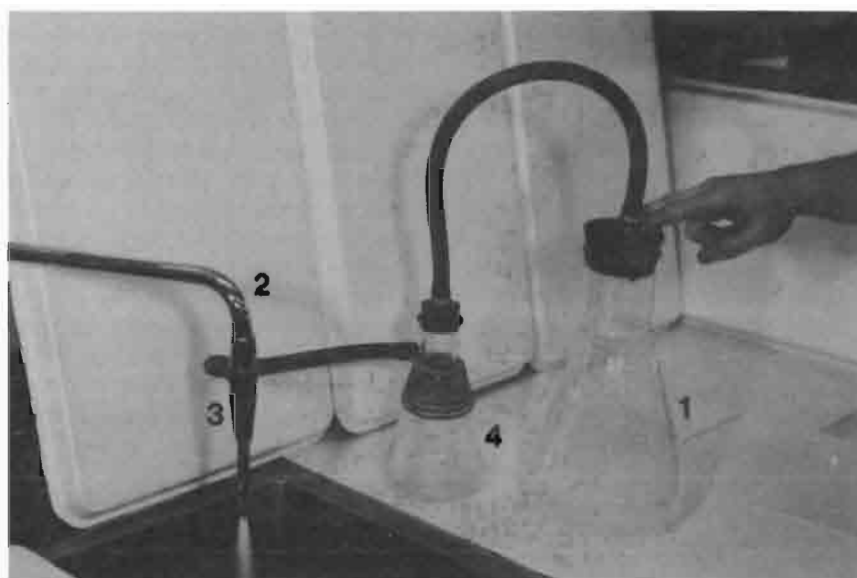

Figure 3

Degasing a solution of hot starch. The large flask (1) contains the hot solution. Water coming out of the spigot (2) creates a suction in the aspirator (3) which draws out the air in the large flask as well as gas trapped in the starch solution. The smaller flask (4) serves as the trap for catching any starch solution that may inadvertently be drawn from the large flask.

mixture is swirled frequently during this time to reduce the chance of burning the starch.

After heating, the starch solution is degased using a water aspirator connected to a trap (Fig. 3). The trap collects any starch solution that might be sucked out of the flask. A hose with a rubber stopper connects the trap to the flask. A hole in the stopper allows control of the vacuum by pressing or raising a finger over the hole, as shown in Figure 3. To begin aspiration, the rubber stopper is placed into the flask opening. The spigot to the aspirator is turned on full-force, and the hole in the stopper is covered with one finger. The small bubbles should rise out of the starch solution, if sufficiently heated, as the solution begins to boil vigorously under this vacuum. If the starch solution bubbles up close to the stopper, some of the vacuum is released by slightly rolling back the finger from the hole of the stopper, then replacing the finger when the

starch solution recedes. An overheated starch solution bubbles up easily. Swirling the starch flask helps to settle the solution and aids in release of air bubbles. Degasing is complete when no small bubbles remain in the starch solution or on the side of the flask; only the large boiling bubbles will remain. The finger is lifted gently off the hole of the stopper to prevent re-entry of air bubbles into the gel.

The starch solution is then poured into the gel mold (Fig. 2). Pouring is done fairly rapidly to reduce the possibility of creating air bubbles. Any air bubbles, lumps, or contaminants can be removed with a pipet before the starch solution begins to cool and set up. The solution can be poured onto the gel strips to increase the thickness of the gel and maximize the number of usable slabs after electrophoresis. In approximately 45 min, when the gel feels cool to the touch, it is ready to be used. Placing the gel briefly in a

refrigerator can speed cooling. Gels can usually be made 1 day in advance with no noticeable effect.² To prevent desiccation, gels are covered with plastic wrap after cooling and stored at room temperature (storage in a refrigerator can alter physical properties of the gel, making them unsuitable for subsequent electrophoresis).

Application of enzyme extracts to a gel

Before the enzyme extracts of the tissue subsamples are applied to a gel, the gel must undergo some initial preparation. A scalpel is drawn vertically around the inside edge of the gel mold and the long strips are removed. Using a sharp, clean scalpel, the gel is cut from side to side, with the aid of a ruler, about 3 cm from the edge of one of the long sides of the gel. The exact location of this incision can vary under special circumstances, depending upon the relative mobility of the enzyme being studied. Care must be taken to ensure a smooth, vertical cut. This cut is referred to as the origin—the location on the gel where enzyme extracts are applied. The narrow strip of gel is called the cathodal strip, and the remaining portion is the anodal piece. The cathodal strip is gently pulled away from the anodal piece using the fingertips until an approximately 1-cm gap is obtained at the origin. The gel, still on the glass plate, is placed on a repackaged, frozen Blue Ice package [(DIVA-SEX, Tustin, CA) Table 1] and is now ready for extract application (Fig. 4).

The frozen tissue subsamples in the test tubes are centrifuged at $2000 \times g$ at room temperature (22°C) for 15 to 20 min. We use a Sorvall RT6000 centrifuge with the H-1000B swinging bucket rotor (DuPont Co., Wilmington, DE). This process thaws the

²The loss of visible electrophoretic variation was observed for pelagic armorhead (*Pentaceros richardsoni*) when the gel had been prepared more than 12 h beforehand. This unusual phenomenon occurred only for the dimeric EST-D locus using liver tissue and the TBCL gel buffer.

tissue and provides a fairly clear enzyme extract. The tubes are transferred from their storage rack into the centrifuge racks for the centrifuge process. After centrifugation, the centrifuge racks with the tubes are placed in an icewater bath or on a frozen Blue Ice package to keep the samples cold during the application process.

The enzyme extract from each test tube is applied to the gel using paper wicks. We make wicks $3-4 \times 13$ mm from heavy-duty filter paper (Schleicher and Schuell No. 470). A wick is picked up with forceps and dipped into a tube (Fig. 5). The wick draws up the extract and is removed from the tube when the wick is soaked to about three-fourths of its length. The reason for not soaking the wick its full length is that a completely saturated wick will lose some extraction fluid when touched to the gel and glass plate. This excess fluid will “run together” with adjacent wicks and adversely affect their electrophoretic patterns. However, it is desirable to introduce as much of the enzyme extraction fluid to the gel as possible. Therefore, close attention is needed to ensure proper soaking of the wicks.

One way to ensure proper soaking of wicks is to observe the reflection of light on the surface of each wick. Just after a wick is removed from a tube, extraction fluid will be present on the surface of the wick, as indicated by the reflection of light on the surface of the wick. As the fluid spreads to the remaining quarter of the wick, the surface fluid is drawn into the wick and light reflection disappears. If this reflection does not disappear, then the wick is oversoaked and some fluid is removed by touching the wick to a paper towel. If the reflection disappears before the full length of the wick is soaked, then additional fluid is drawn up the wick to maximize the amount of sample applied to the gel.

Wicks are placed vertically in the origin on the anodal portion of the gel from left to right (Fig. 4). The wicks will adhere to the gel surface which will aid in their application. The first wick is placed about 5 mm from the left inside edge of the gel. Subsequent wicks are placed in the origin with a separation of about 1 mm. It is important to make sure that each wick is vertical, that it touches

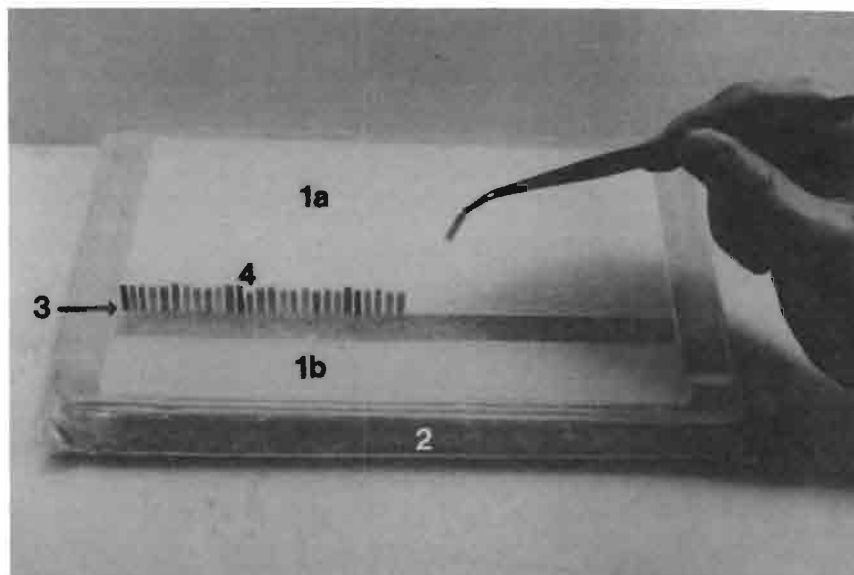

Figure 4

Preparing the gel for application of enzyme extracts and applying wicks to a gel. The gel (1a and 1b) resting on a frozen Blue Ice package (2) is separated at the origin (3). Wicks (4) are placed about 1 mm apart; wicks with marker dyes are placed every 10 specimens. The wide portion of the gel is the anodal piece (1a); the narrow portion is the cathodal strip (1b).

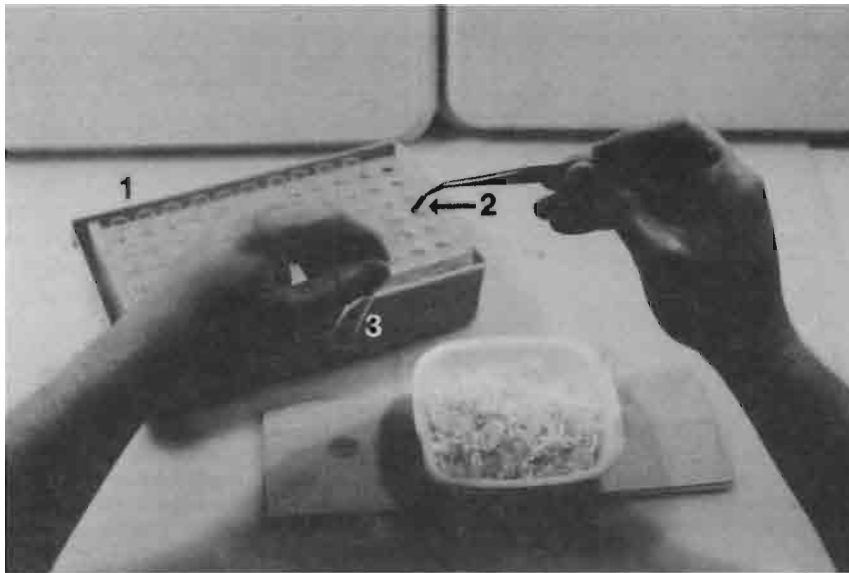

Figure 5

Drawing up the extract onto the wick. Samples are held in an icewater bath (1) or on a Blue Ice package during the wick application process. For each sample, a wick (2) is dipped into a tube (3), allowing the extract to be soaked up, which then is applied to a gel (Fig. 4).

the glass plate, and that adjacent wicks do not touch each other. After each set of 10 wicks, a wick dipped in a red tracking dye is applied.³ Dye markers provide a standardized perspective of how far enzymes have migrated in a gel and aid in recording data. Initially, it may be helpful to apply the dye markers first before applying enzyme extracts to aid in proper spacing of wicks. We routinely apply 40 to 50 extracts plus dye markers to a gel. Since the dye can interfere with migration of some enzymes, we use narrower wicks for dye markers (1–2×13 mm) and increase the space on either side of each marker.

When all the wicks have been applied to the origin, the cathodal gel strip is pushed up close to, but not touching, the wicks and carefully aligned with the anodal piece. This alignment is important because the cathodal strip will stretch when it is moved. If the cathodal strip were in contact with the wicks with this tension, it could cause the wicks to twist out of position as the strip shifted to relieve the tension. After alignment, the cathodal strip is pushed up to make firm contact with the wicks and anodal piece. The inward pressure should be enough to cause the wicks to move with the pressure. The wicks viewed through the gel should have a uniform color. A circular spot of a different shade is evidence of an air pocket. Air pockets disrupt electric current and should be removed by applying localized pressure on the cathodal strip. To prevent desiccation, a piece of plastic wrap, slightly larger than the gel, is placed on the gel surface. A portion of the plastic wrap is folded back exposing approximately 10 mm of the gel surface along the length of both sides of the gel.

³We use a dye solution containing both cathodal and anodal migrating components. The dye consists of one part red food coloring, containing FD and C Red Nos. 3 and 40 (Crescent Mfg. Co., Seattle, WA), and two parts of a histological dye called Fuschin Red (Pararosaniline, Sigma Chemical Co., St. Louis, MO) made up in a 1.0% solution and adjusted to pH 7.0 with 1.0 M NaOH. The two red components in the food coloring migrate anodally. One of these components migrates faster than all enzymes normally detected, and therefore is used to detect the end point of electrophoresis. The other red component migrates approximately one-half as far anodally and is useful in recording data. The Fuschin Red migrates cathodally and therefore is useful as a visual marker for cathodally migrating enzymes.

Setting up a gel for electrophoresis

When the gel is ready for electrophoresis, the gel and glass plate are taken off the Blue Ice package and placed on a cooling plate. A cooling plate is part of a self-contained chilled water-circulation system (Fig. 6). The purpose of the system is to remove heat generated during electrophoresis and keep the gel cold, minimizing enzyme degradation. Alternatively, the gel may be cooled on a Blue Ice package or in a refrigerator. An electrode buffer tray is placed on either side of the cooling plate. We use “organizer trays” (Rubber Maid Inc., Wooster, OH), 23×7 cm, cut down to a height of 3 cm. Approximately 250 mL of electrode buffer (Appendix 2) is used for each tray. The connection between the electrode buffer and the gel is made using absorbent sponge cloths [(e.g., Everywhere Wiper, Lola Products Corp., Hackensack, NJ) Table 1]. The cloths are allowed to absorb the electrode buffer in the buffer tray, then they are placed on the surface of the exposed portions of both sides of the gel and tucked in along both vertical edges of the gel. Moderate pressure is applied to the cloths to ensure good contact (Fig. 7). The gel is connected to a DC power supply (capable of an output of 400 V) using two electrodes.⁴ The electrode connected to the positive terminal is placed in the electrode buffer adjacent to the anodal piece. The electrode connected to the negative terminal is placed in the electrode buffer adjacent to the cathodal strip. Electrodes are held in place with wooden clips (Fig. 7).⁵

⁴The electrodes are made from a patch cord having a banana plug at each end. The cord is cut in half and a portion of the exposed wire is wrapped around a 3-cm piece of 20-gauge platinum wire. Platinum wire is necessary because of its resistance to corrosion during electrophoresis. A short piece of flexible tubing, which fits snugly around the patch cord, is pushed over the wire covering the connection. Epoxy is used to fill the open end of the tubing which seals the connection from possible corrosion during electrophoresis but leaves at least 2 cm of exposed platinum wire.

⁵With this electrophoresis setup there is the possibility of electrical shock. Therefore, it is necessary to exercise caution when working with or near gels during electrophoresis.

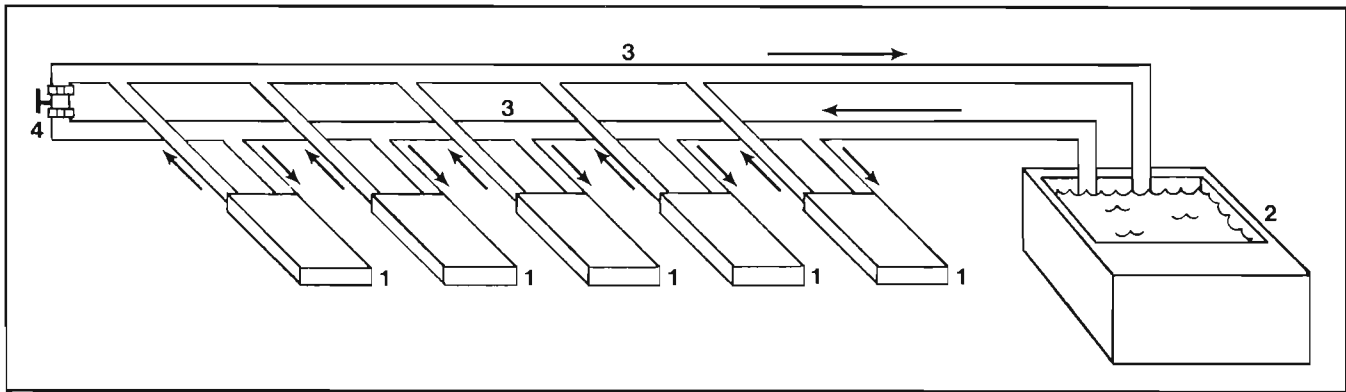

Figure 6

Cooling system for gels with five cooling plates (1). A cooling plate is a watertight box with internal channels causing water to circulate into and out of the plate (see Table 1 for dimensions). The top surface of the plate is aluminum to facilitate heat transfer. A thin sheet of plastic covers the aluminum surface to insulate it from the electrical current. Each plate is connected to a 2°C water circulating chiller (2) via a system of PVC pipe and insulated tubing (3) which pumps water through the system. A valve (4) at the end of the PVC pipe system controls the amount of water flow through the plates. Arrows indicate direction of flow.

Current is now applied to the gel. The voltage and milliamp settings will vary depending upon the buffer. For the three buffers we commonly use (see Appendix 2), AC and TBCL gels run at 250 V, whereas a TBE gel runs at 350 V. Current is never allowed to go higher than 70 mA to prevent the buildup of excess heat, which would result in suboptimal electrophoretic separation. The current is applied for 15 min with the wicks in place. After this time, the power is turned off and the wicks are removed (it is necessary to remove the wicks because in time the wicks begin to dry out, which will hinder current flow across the gel).

Removing the wicks and reassembling the gel to continue electrophoresis are critical steps. Proper attention and care are necessary to ensure straight, consistent migration of enzymes in the gel matrix. The power is turned off and the electrode buffer cloth on the cathodal side is folded back into the buffer tray. The plastic wrap is folded back to expose the origin and wicks. The cathodal strip is pulled away from the wicks. Using forceps, the wicks are carefully removed and discarded. Bits of the wick paper will often stick to the gel. The origin must be very clean for current to flow evenly across the gel. To ensure a clean origin, tips of the forceps are dipped into the electrode buffer and then carefully run along both sides of the origin, picking up bits of filter paper along the way. It may be necessary to repeat this step several times to get the origin clean. The cathodal strip is then pushed back up firmly against the anodal strip, taking care not to trap air between the two sides of the gel at the origin. To minimize the occurrence of air pockets, start at one end of the cathodal strip, or in the middle, and push it up to the anodal piece at a wide angle to the origin (as opposed to no angle when you push the cathodal strip up to the anodal piece when the wicks are still in place). As before, trapped air pockets can be seen as a change in color at the origin. These pockets can easily be removed by gently pulling the surface of the gel away from the origin. After contact is made, the cathodal strip can be moved from side to side to line it up properly with the anodal piece (as opposed to prealigning the cathodal strip when the wicks are still in place). The plastic wrap and cloth are then replaced and the current reapplied to the gel.

The amount of time for an electrophoretic run depends upon the buffer type and the amount of separation that is needed for the enzymes of interest. Typically, we run AC and TBE gels until the fast red dye migrates to the far edge of the anodal piece (approximately 10 cm from the origin). This takes about 4 h for an AC gel

and about 5 h for a TBE gel. A TBCL gel has a visible "boundary" which migrates through the gel; the fast red dye migrates with this boundary zone. We usually run the fast red dye in a TBCL gel until it has moved 6 to 7 cm, about 3.5 to 4 h.

Slicing a gel

Following completion of electrophoresis, the gel is sliced horizontally into a number of thin slabs. Each slab can be individually stained for a different enzyme. Prior to slicing, the gel and glass plate are removed from the cooling system and placed on a firm foundation. The plastic wrap and short plastic strips are removed. The corners of the gel on the end where the first wick was applied are cut off at an angle. This is done to keep track of the direction of extract application on the gel. A narrow sliver is cut off the entire side of the other end of the gel so that the leading edge for slicing will have a consistent, moist texture. Also, a cm or more of gel may be cut off the entire length of the outside of the anodal edge to facilitate accurate slicing when it is known that no enzymes of interest have migrated that far.

Before slicing the gel, it is necessary to determine if the gel is adhering to the glass plate. Gels can collect moisture between the glass plate and the gel, causing them to slide off the plate during slicing. To obviate this problem, both the cathodal strip and anodal piece are carefully removed, placed briefly on paper towels, and then repositioned on a dry glass plate. After repositioning, any air bubbles beneath the gel are gently pressed out.

The gel and glass plate are then returned to their foundation for slicing and positioned as illustrated in Figure 8. Two plastic "slicing" strips (see Table 1) are placed on the glass plate along both long sides of the gel. To keep the slicing strips from sliding off during slicing, they may be placed so that they rest against the technician, or they may be clamped to the glass plate. The gel is sliced by pulling a piece of nylon thread or 2-lb test monofilament fishing line (approximately 90 cm long) through the gel, using the slicing strips for adjusting the height of the slice through the gel. The ends of the thread are wrapped securely around both index fingers with enough thread between fingers to span the width of the gel. With both index fingers pointed toward the technician, the thumbs are placed on the thread and pressed onto the two slicing strips above the top edge of the gel as shown in Figure 8. The

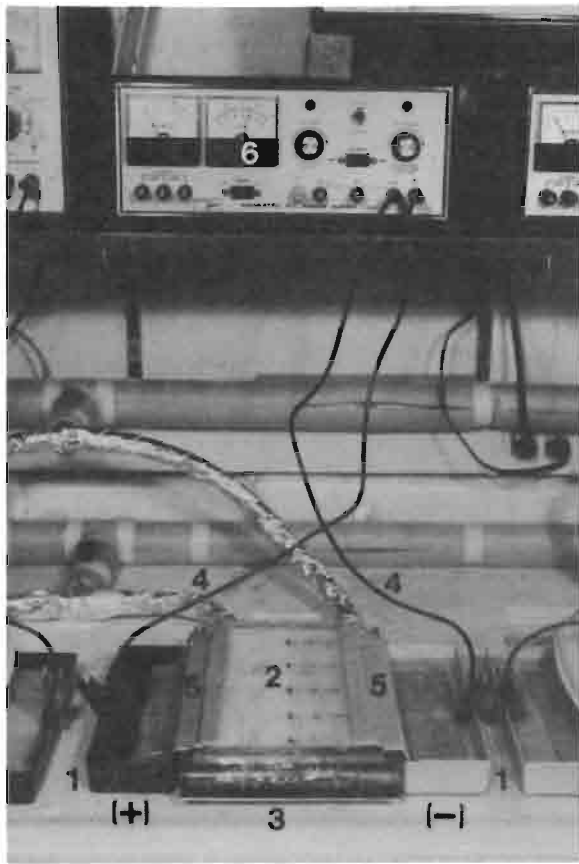

Figure 7

A gel setup for electrophoresis. Electrode buffer trays (1) are on each side of the gel (2) which is on a cooling plate (3). Electrodes (4) are held in the electrode buffer with wooden clips. Absorbent cloths (5) connect the electrode buffer to the gel. The cathodal (-) and anodal (+) portions of the gel are determined by their connection to the power supply (6).

thread is entered at a slight angle to the leading edge of the gel and drawn through at a slow but constant rate. Constant tautness on the thread and slight downward pressure on the slicing strips are maintained. The amount of tautness and pressure needed to ensure accurate slicing can be learned only by experience. Only a slight arc in the thread should be present as it passes through the gel. If too little tension is applied, the thread will fluctuate down to a lower slice in the gel, affecting the smooth slicing of both slabs. If too much tension is applied, the thread will break; if this happens, the slice is simply done again with another piece of thread. After making the slice, another slicing strip is placed on top of each of the previous slicing strips and the process repeated until the top of the gel is reached. The first and final slices are often the most difficult, so the thread is drawn through extra slowly to achieve smooth slices. Up to seven or eight usable slabs can be cut from a single 300-mL gel in this manner. Plastic slicing strips up to 2 mm thick are sometimes used when fewer slabs are needed, or when a thicker slab gives greater levels of enzyme activity.

Staining a gel

The slabs of a sliced gel are now prepared for staining. The top slab has a rubbery upper surface due to its exposure to the air and always gives very poor enzyme resolution. Therefore, this slab is peeled off and set aside (it is possible to slice and remove the top

slab prior to electrophoresis which can help migration and resolution of the enzymes as well as decrease the time of electrophoresis). Subsequent slabs are peeled off and individually placed on glass plates (Table 1). The cathodal strip may be placed and aligned with the anodal piece depending upon location of the enzyme of interest. The thin slabs are sometimes difficult to handle at first because they are easily torn and slightly tacky. One method for handling them is to get the fingertips of one hand under one end of the gel near the edge, gently lift the slab all the way off, and then get the fingertips of the other hand under the end of the slab that is hanging. Others use a method by which both hands hold one end of the gel while the other end is left to hang down. A spatula can help in separating the slabs. Some find it useful to wet their fingers and the glass plate to aid in the handling of the slabs. Slabs torn during handling can usually be pieced back together and stained. The upper slabs of the gel provide poorer enzyme resolution than lower slabs of the gel due to the top rubbery slab. Thus, the first two usable slabs next to the rubbery top slab are inverted, when laid out on the glass plate, to expose the lower surface of the gel for staining. When laying out the slabs, it is best to avoid trapping air bubbles under the gel slab as they can affect the even distribution of the stain. Each slab is appropriately labeled with population name, sample numbers, buffer type, and enzyme abbreviation using transparent tape applied to the glass plate.

To stain each gel slab, a mixture of a hot agar solution and a staining reagent is poured over the gel slab. We use a 2% agar solution for staining, i.e., 2 g agar dissolved by heating in 100 mL of distilled water. The desired amount of agar is sifted into heated, distilled water which is just about to boil. The solution is swirled frequently as the agar is added, to minimize the possibility of creating lumps. The solution is kept on "low" heat with intermittent swirling until no granules are visible in the solution. Once it is melted, the agar solution is held as a liquid at 65°C in a hot water bath. Hardened agar is reused by remelting the agar in a boiling water bath. A microwave oven works well in dissolving agar as well as in remelting hardened agar. We use granular agar (Bacto-Agar, Difco Laboratories, Detroit, MI), as opposed to a powdered agar, because it melts faster and produces a clear solution.

A staining reagent, in general, consists of a buffer of an appropriate pH containing the substrate for a particular enzyme, any cofactors or enhancers that are required for that particular enzyme, and a dye.⁶ Typically, the dye precipitates or changes color in the presence of one of the products of the enzyme reaction. In some cases, the site of enzyme activity can be detected by the lack or presence of fluorescence under an ultraviolet light. In either case, the results of staining are visible bands where the enzyme is present in the gel slab. Interpretation of these banding patterns is thoroughly covered in Utter et al. (1987).

To cover one gel slab, 25 mL of the staining mixture (three parts staining reagent and two parts liquid agar) are needed. When pouring this mixture over the gel surface, a spatula is sometimes used to help spread the staining mixture evenly over the gel and to hold back or remove bubbles. After a minute or less, the agar will set up or gel, and the stained gel slab on the glass plate can be put into an incubator. Incubation at 37°C is used for most enzymes to speed up enzyme reaction and limit exposure to light (some of the dyes that are used are reactive to light). Incubation time varies depending upon the enzyme: some enzymes produce bands almost

⁶A number of chemicals used in the stains, particularly the dyes, are hazardous and should be handled with caution. It is advisable to (1) measure out the hazardous chemicals in a hood to minimize the breathing of dust and (2) wear disposable gloves when preparing or pouring stains and in handling the stained gel plates. Hazardous chemicals are usually readily identified with warning labels on the container.

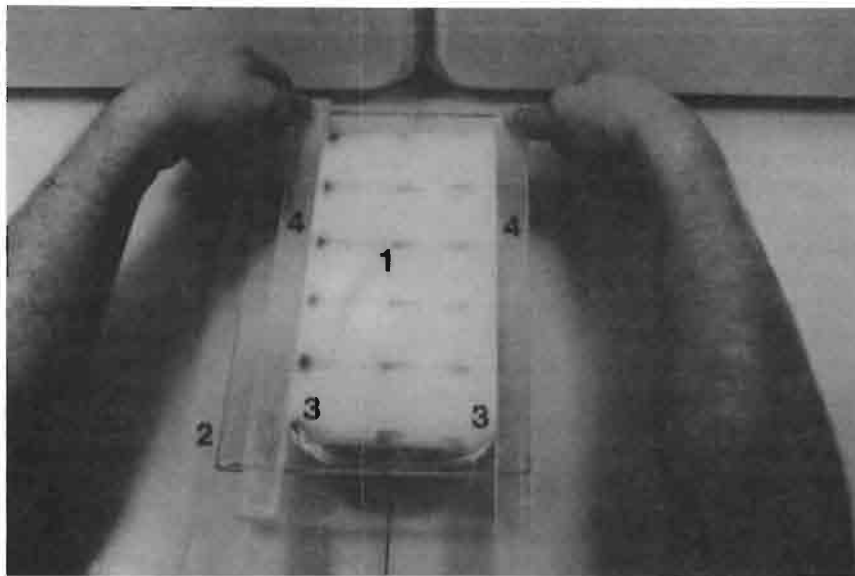

Figure 8

Slicing a gel. The gel (1) has been moved onto a dry glass plate (2) and positioned so the edge with the cut corners (3) is toward the technician. A slicing strip (4) is placed along both sides of the length of the gel. A piece of nylon thread, wrapped around both index fingers and held taut, is pulled along the surface of the two slicing strips to slice the gel. Two more slicing strips are added, and the slicing process repeated until the top of the gel is reached.

immediately, whereas others take 30 min or longer before any activity is seen. Thus, it is important to monitor the progress of each stain so that no gels are allowed to "overstain" before the results can be recorded. The results of the enzyme stains can be preserved by photographing those gels which reveal data of particular interest. Stain preparation procedures and complete staining recipes for 47 enzymes are given in Appendix I.

Acknowledgments

We thank the many reviewers for their time and constructive thoughts on this manuscript, Laurie Barber and Linda Carlquist for typing the manuscript, and Janice So for design and artwork of the cover and Figure 1.

Citations

- AEBERSOLD, P. B., G. B. MILNER, G. A. WINANS.
1986. Starch gel electrophoresis: the effect of tissue disruption procedures and tissue dilution buffers on the staining activity of specific enzymes. Unpubl. manusc., Northwest Alaska Fish. Cent., Natl. Mar. Fish. Serv., NOAA, 2725 Montlake Blvd. E., Seattle, WA 98112.
- AVISE, J. C.
1974. Systematic value of electrophoretic data. *Syst. Zool.* 23:465-481.
- AYALA, F. J.
1976. *Molecular evolution*. Sinauer Assoc. Inc., Sunderland, MA, 277 p.
- BOYER, S. H., D. C. FAINER, and M. A. NAUGHTON.
1963. Myoglobin: inherited structural variation in man. *Science* 140:1228-1231.
- BREWER, G. J., AND C. F. SING.
1970. *An introduction to isozyme techniques*. Academic Press, Inc., New York, 186 p.
- CLAYTON, J. W., and D. N. TRETIAK.
1972. Amine-citrate buffers for pH control in starch gel electrophoresis. *J. Fish. Res. Board Can.* 29:1169-1172.
- HARRIS, H., and D. A. HOPKINSON.
1976. *Handbook of enzyme electrophoresis in human genetics*. American Elsevier, New York.
- HARTL, D.
1980. *Principles of population genetics*. Sinauer Assoc. Inc., Sunderland, MA, 488 p.
- INTERNATIONAL UNION OF BIOCHEMISTRY.
1984. *Enzyme nomenclature 1984*. Academic Press, Inc., Orlando, FL, 646 p.
- MAY, B., J. E. WRIGHT, and M. STONEKING.
1979. Joint segregation of biochemical loci in salmonids: results from experiments with *Salvelinum* and review of the literature in other species. *J. Fish. Res. Board Can.* 36:1114-1128.
- NEVO, E., A. BEILES, and R. BEN-SHLOMO.
1984. The evolutionary significance of genetic diversity: ecological, demographic and life history correlates. In Mani, G. S. (editor), *Evolutionary dynamics of genetic diversity*, p. 13-213. *Lecture Notes Biomath.* 53, Springer-Verlag, New York.
- RIDGWAY, G. J., S. W. SHERBURNE, and R. D. LEWIS.
1970. Polymorphism in the esterases of Atlantic herring. *Trans. Am. Fish. Soc.* 99:147-151.
- SHAKLEE, J. B., and C. P. KEENAN.
1986. A practical laboratory guide to the techniques and methodology of electrophoresis and its application to fish fillet identification. CSIRO Marine Laboratories Publ. 177, Melbourne, Australia, 59 p.
- SICILIANO, M. R., and C. R. SHAW.
1976. Separation and visualization of enzymes on gels. In Smith, I. (editor), *Chromatographic and electrophoretic techniques*, Vol. 2, p. 185-209. Zone electrophoresis. Heinemann, London.
- SMITH, I.
1968. Techniques of starch gel electrophoresis. In Smith, I. (editor), *Chromatographic and electrophoretic techniques*, Vol. 2, p. 217-238. Zone electrophoresis. Interscience Publishers, John Wiley and Sons, Inc., New York.
- UTTER, F. M., H. O. HODGINS, and F. W. ALLENDORF.
1974. Biochemical genetic studies of fishes: potentialities and limitations. In Malins, D. (editor), *Biochemical and biophysical perspective in marine biology*, Vol. 1, p. 213-237. Academic Press, San Francisco.
- UTTER, F. M., P. B. AEBERSOLD, and G. A. WINANS.
1987. Interpreting genetic variation detected by electrophoresis. In Ryman, N., and F. M. Utter (editors), *Population genetics and fishery management*, p. 21-45. Sea Grant Publications, Seattle, WA.

APPENDIX 1: Staining recipes

Following is a list of staining recipes for enzymes which we use in our electrophoretic studies of fishes. They are adapted from recipes given in Harris and Hopkinson (1976) and Siciliano and Shaw (1976) using the agar overlay method. They are divided into four categories to facilitate stain preparation: stains involving NAD⁺ dependent enzymes, stains involving NADP⁺ dependent enzymes, enzymes detected with ultraviolet light, and miscellaneous stains. For each enzyme stain, the full enzyme name is given as well as an abbreviation, the presumed or observed subunit structure of the enzyme when known, and the number assigned to the enzyme by the Enzyme Commission (E.C.) of the International Union of Biochemistry (1984). When preparing the stains, items can be premixed on the day to be used except for those preceded by an asterisk, which should be added just prior to staining. Items are listed in order of most common use. Stain buffers, which are

usually the first item, are made at a given concentration and adjusted to the desired pH with the item following the slash (/). For HCl, we use a 12.1-M concentrated solution, and for citric acid a 1.0-M solution. All phosphate buffers are made by mixing appropriate quantities of monobasic, dibasic, or tribasic sodium phosphate 0.1 M solutions to achieve the desired pH. Items which are listed as percent solutions (g per 100 mL) are dissolved in distilled water unless indicated otherwise. To expedite the preparation of stains, it is useful to rely on an "estimated volumetric unit" (EVU) as opposed to weighing out each chemical, and to use drops of coupling enzymes from a pipet by calculating the number of units in a drop. EVU equivalents are given next to milligram quantities and relate to the approximate volume these quantities yield when measured by eye on the tip of a spatula.

List of abbreviations

ADP	Adenosine diphosphate
ATP	Adenosine triphosphate
DMSO	Dimethyl sulfoxide
E.C.	Enzyme Commission, Intl. Union Biochem.
EVU	Estimated volumetric unit
FAD	Flavine adenine dinucleotide
GAPDH	Glyceraldehyde-3-phosphate dehydrogenase
G6PDH	Glucose-6-phosphate dehydrogenase
GDH	Glutamate dehydrogenase
HCl	Hydrochloric acid
LDH	Lactate dehydrogenase
MgCl ₂	Magnesium chloride
MTT	3-(4,5-Dimethyl-2-thiazolyl)-2,5-diphenyl-2H-tetrazolium bromide
NAD ⁺	β-Nicotinamide adenine dinucleotide
NADH	β-Nicotinamide adenine dinucleotide (reduced)
NADP ⁺	β-Nicotinamide adenine dinucleotide phosphate
NADPH	β-Nicotinamide adenine dinucleotide phosphate (reduced)
NaOH	Sodium hydroxide
PMS	Phenazine methosulfate
XO	Xanthine oxidase

Stains Involving NAD⁺ Dependent Enzymes

Alanine aminotransferase dimer	ALAT E.C. 2.6.1.2
0.1 M Phosphate, 0.1% α-Ketoglutaric acid, pH 8.5	15 mL
NAD ⁺ 0.5%	0.5 mL
ADP	7 mg (1/2 EVU)
Pyridoxal-5-phosphate	0.5 mg (1/50 EVU)
L-Alanine	20 mg (1/2 EVU)
*GDH (suspended in 50% glycerol with negligible ammonium ions)	100 units
*MTT 0.5%	0.5 mL
*PMS 0.5%	0.5 mL
*Agar 2.0%	10 mL
Incubate at 37°C in the dark until sufficient activity is present.	
Alcohol dehydrogenase dimer	ADH E.C. 1.1.1.1
0.2 M Tris/HCl, pH 8.0	15 mL
NAD ⁺ 0.5%	0.5 mL
Ethyl alcohol 100%	0.08 mL
*MTT 0.5%	0.5 mL
*PMS 0.5%	0.5 mL
*Agar 2.0%	10 mL
Incubate at 37°C in the dark until sufficient activity is present.	
Fructose-biphosphate aldolase tetramer	FBALD E.C. 4.1.1.13
0.2 M Tris/HCl, pH 8.0	15 mL
NAD ⁺ 0.5%	0.5 mL
Arsenic acid (sodium salt)	50 mg (1 EVU)
Fructose-1, 6-diphosphate	28 mg (1 EVU)
*GAPDH	200 units
*MTT 0.5%	0.5 mL
*PMS 0.5%	0.5 mL
*Agar 2.0%	10 mL
Incubate at 37°C in the dark until sufficient activity is present.	
Fumarate hydratase tetramer	FH E.C. 4.2.1.2
0.2 M Tris/HCl, pH 8.0	15 mL
NAD ⁺ 0.5%	0.5 mL
Pyruvic acid (sodium salt)	5 mg (1/4 EVU)
Fumaric acid (sodium salt)	50 mg (1 EVU)
*Malate dehydrogenase	300 units
*MTT 0.5%	0.5 mL
*PMS 0.5%	0.5 mL
*Agar 2.0%	10 mL
Incubate at 37°C in the dark until sufficient activity is present.	

Glutamate dehydrogenase hexamer	GDH E.C. 1.4.1.2
0.1 M Phosphate, pH 8.5	15 mL
NAD ⁺ 0.5%	0.5 mL
ADP	7 mg (1/2 EVU)
L-Glutamic acid (sodium salt)	45 mg (1 EVU)
*Pyridoxal-5-phosphate	0.5 mg (1/50 EVU)
*MTT 0.5%	0.5 mL
*PMS 0.5%	0.5 mL
*Agar 2.0%	10 mL
Incubate at 37°C in the dark until sufficient activity is present.	
Glyceraldehyde-3-phosphate dehydrogenase tetramer	GAPDH E.C. 1.2.1.12
0.2 M Tris/HCl, pH 8.0	15 mL
NAD ⁺ 0.5%	0.5 mL
Arsenic acid (sodium salt)	50 mg (1 EVU)
Aldolase	20 units
Fructose-1, 6-diphosphate	28 mg (1 EVU)
*MTT 0.5%	0.5 mL
*PMS 0.5%	0.5 mL
*Agar 2.0%	10 mL
Incubate at 37°C in the dark until sufficient activity is present.	
Glycerol-3-phosphate dehydrogenase dimer	G3PDH E.C. 1.1.1.8
0.2 M Tris/HCl, pH 8.5	15 mL
NAD ⁺ 0.5%	0.5 mL
α-Glycerophosphate	35 mg (1 EVU)
*MTT 0.5%	0.5 mL
*PMS 0.5%	0.5 mL
*Agar 2.0%	10 mL
Incubate at 37°C in the dark until sufficient activity is present.	
Hydroxyacylglutathione hydrolase dimer	HAGH E.C. 3.1.2.6
0.2 M Tris/HCl, pH 8.0	15 mL
Methyl glyoxal	0.24 mL
Glutathione (reduced)	25 mg (1 EVU)
Lactoyl-glutathione lyase (GLOI)	150 units
*NAD ⁺ 0.5%	3 mL
*Pyruvic acid (sodium salt)	5 mg (1/4 EVU)
*1.0 M Zinc chloride	0.08 mL
*LDH	400 units
*MTT 0.5%	0.5 mL
*PMS 0.5%	0.5 mL
*Agar 2.0%	10 mL
Rinse all glassware used in stain with distilled water prior to use.	
Mix first four items at least 30 min prior to staining.	
Incubate at 37°C in the dark until sufficient activity is present.	

L-iditol dehydrogenase tetramer	IDDH E.C. 1.1.1.14
0.2 M Tris/HCl, pH 8.5	13 mL
NAD ⁺ 0.5%	0.5 mL
Sorbital 50.0%	2 mL
*MTT 0.5%	0.5 mL
*PMS 0.5%	0.5 mL
*Agar 2.0%	10 mL
Incubate at 37°C in the dark until sufficient activity is present.	
Lactate dehydrogenase tetramer	LDH E.C. 1.1.1.27
0.2 M Tris/HCl, pH 8.0	13 mL
NAD ⁺ 0.5%	0.5 mL
0.5 M Lactic acid/NaOH (~0.5 M), pH 8.0	2 mL
*MTT 0.5%	0.5 mL
*PMS 0.5%	0.5 mL
*Agar 2.0%	10 mL
Incubate at 37°C in the dark until sufficient activity is present.	
Malate dehydrogenase dimer	MDH E.C. 1.1.1.37
0.2 M Tris/HCl, pH 8.0	13 mL
NAD ⁺ 0.5%	0.5 mL
0.5 M Malic acid/NaOH (~1.0 M), pH 7.0	2 mL
*MTT 0.5%	0.5 mL
*PMS 0.5%	0.5 mL
*Agar 2.0%	10 mL
Incubate at 37°C in the dark until sufficient activity is present.	

Triosephosphate isomerase dimer	TPI E.C. 5.3.1.1
0.03 M Tris, 0.005 M Citric acid, 0.6 mM Lithium hydroxide, 3.0 mM Boric Acid (TBCL gel buffer diluted 1 in 10, see Appendix 1), pH 8.7	15 mL
NAD ⁺ 0.5%	0.5 mL
Arsenic acid (sodium salt)	25 mg (1/2 EVU)
Dihydroxyacetone phosphate (lithium salt)	10 mg (1/2 EVU)
*GAPDH	200 units
*MTT 0.5%	0.5 mL
*PMS 0.5%	0.5 mL
*Agar 2.0%	10 mL
Incubate at 37°C in the dark until sufficient activity is present.	
Tyrosine aminotransferase subunit structure uncertain	TAT E.C. 2.6.1.5
0.2 M Tris/HCl, pH 8.5	15 mL
NAD ⁺ 0.5%	0.5 mL
ADP	7 mg (1/2 EVU)
α-Ketoglutaric acid	8 mg (1/4 EVU)
L-Tyrosine/HCl 5.0% in 1.0 M HCl	0.2 mL
*Pyridoxal-5-phosphate	0.5 mg (1/50 EVU)
*GDH (suspended in 50% glycerol with negligible ammonium ions)	100 units
*MTT 0.5%	0.5 mL
*PMS 0.5%	0.5 mL
*Agar 2.0%	10 mL
Incubate at 37°C in the dark until sufficient activity is present.	

Stains Involving NADP⁺ Dependent Enzymes

Aconitate hydratase monomer	AH E.C. 4.2.1.2
1.0 M Tris/HCl, pH 8.0	15 mL
NADP ⁺ 0.25%	0.5 mL
1.0 M MgCl ₂	1 mL
Aconitic acid	12 mg (1/2 EVU)
*Isocitrate dehydrogenase	5 units
*MTT 0.5%	0.5 mL
*PMS 0.5%	0.5 mL
*Agar 2.0%	10 mL
Incubate at 37°C in the dark until sufficient activity is present.	

Adenylate kinase monomer	AK E.C. 2.7.4.3
0.2 M Tris/HCl, pH 8.0	15 mL
NADP ⁺ 0.25%	0.5 mL
1.0 M MgCl ₂	0.25 mL
G6PDH	12 units
Glucose	100 mg (2 EVU)
ADP	14 mg (1 EVU)
*Hexokinase	1.5 mg (1/4 EVU)
*MTT 0.5%	0.5 mL
*PMS 0.5%	0.5 mL
*Agar 2.0%	10 mL
Incubate a 37°C in the dark until sufficient activity is present.	

Creatine kinase dimer¹	CK E.C. 2.7.3.2
0.2 M Tris/HCl, pH 8.0	15 mL
NADP ⁺ 0.25%	0.5 mL
1.0 M MgCl ₂	0.25 mL
G6PDH	12 units
Glucose	100 mg (2 EVU)
ADP	14 mg (1 EVU)
Phosphocreatine	18 mg (1 EVU)
*Hexokinase	1.5 mg (1/4 EVU)
*MTT 0.5%	0.5 mL
*PMS 0.5%	0.5 mL
*Agar 2.0%	10 mL
Incubate at 37°C in the dark until sufficient activity is present.	
¹ In fish, the skeletal muscle CK isozymes act as monomers.	
Glucose-6-phosphate dehydrogenase dimer	G6PDH E.C. 1.1.1.49
0.2 M Tris/HCl, pH 8.0	15 mL
NADP ⁺ 0.25%	0.5 mL
1.0 M MgCl ₂	0.25 mL
Glucose-6-phosphate	50 mg (2 EVU)
*MTT 0.5%	0.5 mL
*PMS 0.5%	0.5 mL
*Agar 2.0%	10 mL
Incubate at 37°C in the dark until sufficient activity is present.	
Glucose-6-phosphate isomerase dimer	GPI E.C. 5.3.1.9
0.2 M Tris/HCl, pH 8.0	15 mL
NADP ⁺ 0.25%	0.5 mL
1.0 M MgCl ₂	0.25 mL
G6PDH	12 units
Fructose-6-phosphate	5 mg (1/4 EVU)
*MTT 0.5%	0.5 mL
*PMS 0.5%	0.5 mL
*Agar 2.0%	10 mL
Incubate at 37°C in the dark until sufficient activity is present.	
Hexokinase monomer	HK E.C. 2.7.1.1
0.2 M Tris/HCl, pH 8.0	15 mL
NADP ⁺ 0.25%	0.5 mL
1.0 M MgCl ₂	0.25 mL
G6PDH	12 units
Glucose	100 mg (2 EVU)
ATP	14 mg (1 EVU)
*MTT 0.5%	0.5 mL
*PMS 0.5%	0.5 mL
*Agar 2.0%	10 mL
Incubate at 37°C in the dark until sufficient activity is present.	

Isocitrate dehydrogenase dimer	IDH E.C. 1.1.1.42
0.2 M Tris/HCl, pH 8.0	15 mL
NADP ⁺ 0.25%	0.5 mL
1.0 M MgCl ₂	0.25 mL
Isocitric acid (sodium salt)	36 mg (1 EVU)
*MTT 0.5%	0.5 mL
*PMS 0.5%	0.5 mL
*Agar 2.0%	10 mL
Incubate at 37°C in the dark until sufficient activity is present.	
Malate dehydrogenase (NADP⁺) tetramer	MDHp E.C. 1.1.1.40
0.2 M Tris/HCl, pH 8.0	13 mL
NADP ⁺ 0.25%	0.5 mL
1.0 M MgCl ₂	0.5 mL
Oxaloacetic acid	9 mg (1/4 EVU)
0.5 M Malic acid/NaOH (~1.0 M), pH 7.0	2 mL
*MTT 0.5%	0.5 mL
*PMS 0.5%	0.5 mL
*Agar 2.0%	10 mL
Incubate at 37°C in the dark until sufficient activity is present.	
Mannose-6-phosphate isomerase monomer	MPI E.C. 5.3.1.8
0.03 M Tris, 0.005 M Citric acid, 0.6 mM Lithium hydroxide, 3.0 mM Boric acid (TBCL gel buffer diluted 1 in 10, see Appendix 1), pH 8.7	15 mL
NADP ⁺ 0.25%	0.5 mL
1.0 M MgCl ₂	0.25 mL
G6PDH	12 units
Mannose-6-phosphate	7 mg (1 EVU)
*Glucose-6-phosphate isomerase	10 units
*MTT 0.5 %	0.5 mL
*PMS 0.5%	0.5 mL
*Agar 2.0%	10 mL
Incubate at 37°C in the dark until sufficient activity is present.	
Phosphoglucomutase monomer	PGM E.C. 5.4.2.2
0.2 M Tris/HCl, pH 8.0	15 mL
NADP ⁺ 0.25%	0.5 mL
1.0 M MgCl ₂	0.1 mL
G6PDH	6 units
Glucose-1-phosphate (with 1% glucose-1, 6-diphosphate)	13 mg (1/2 EVU)
*MTT 0.5%	0.5 mL
*PMS 0.5%	0.5 mL
*Agar 2.0%	10 mL
Incubate at 37°C in the dark until sufficient activity is present.	

Phosphogluconate dehydrogenase dimer	PGDH E.C. 1.1.1.44
0.2 M Tris/HCl, pH 8.0	15 mL
NADP ⁺ 0.25%	0.5 mL
1.0 M MgCl ₂	0.25 mL
6-Phosphogluconic acid (ammonium salt)	20 mg (1 EVU)
*MTT 0.5%	0.5 mL
*PMS 0.5%	0.5 mL
*Agar 2.0%	10 mL
Incubate at 37°C in the dark until sufficient activity is present.	

Enzymes Detected with Ultraviolet Light

β-N-Acetylgalactosaminidase dimer	βGALA E.C. 3.2.1.53
0.1 M Phosphate/Citric acid, pH 9.5	15 mL
*4-Methylumbelliferyl-N-acetyl-β-D- galactosaminide (dissolve first in 0.25 mL DMSO)	5 mg (1/4 EVU)
*Agar 2.0%	10 mL
Incubate at 37°C, until sufficient activity is visible under long- wave (365 nm) UV light.	
N-Acetyl-β-glucosaminidase dimer	βGA E.C. 3.2.1.30
0.1 M Phosphate/Citric acid, pH 4.5	15 mL
*4-Methylumbelliferyl-N-acetyl-β-D- glucosaminide (dissolve first in 0.25 mL DMSO)	5 mg (1/4 EVU)
*Agar 2.0%	10 mL
Incubate at 37°C, until sufficient activity is visible under long- wave (365 nm) UV light.	
Acid phosphates dimer	ACP E.C. 3.1.3.2
0.1 M Phosphate/Citric acid, pH 3.5 or 6.5	15 mL
*4-Methylumbelliferyl phosphate	4.5 mg (1/2 EVU)
*Agar 2.0%	10 mL
Incubate at 37°C, until sufficient activity is visible under long- wave (365 nm) UV light.	

Enolase dimer	ENO E.C. 4.2.1.11
0.2 M Tris/HCl, pH 8.0	15 mL
ADP	14 mg (1 EVU)
Fructose-1, 6-diphosphate	7 mg (1/4 EVU)
1.0 M MgCl ₂	0.5 mL
Potassium chloride	165 mg (3 EVU)
2-Phosphoglyceric acid (sodium salt)	12 mg (1 EVU)
*NADH	30 mg (3 EVU)
*Pyruvate kinase	200 units
*LDH	400 units
*Agar 2.0%	10 mL
Incubate at 37°C, until sufficient activity is visible under long- wave (365 nm) UV light.	
Esterase-D dimer¹	EST-D E.C. 3.1.1.*
0.1 M Phosphate, pH 7.0	15 mL
4-Methylumbelliferyl acetate (or butyrate) (dissolve first in 0.5 mL acetone)	1.5 mg (1/4 EVU)
*Agar 2.0%	10 mL
Incubate at 37°C, until sufficient activity is visible under long- wave (365 nm) UV light.	
¹ In addition to a unique dimeric locus, this stain also detects a class of enzymes which does not represent a single ancestral lineage; therefore subunit structure may vary among loci.	

α-Glucosidase tetramer	αGLU E.C. 3.2.1.20
0.1 M Phosphate/Citric acid, pH 8.0	15 mL
*4-Methylumbelliferyl- α -D-glucoside	3 mg (1/4 EVU)
*Agar 2.0%	10 mL
Incubate at 37°C, until sufficient activity is visible under long-wave (365 nm) UV light.	
α-Mannosidase subunit structure uncertain	αMAN E.C. 3.2.1.24
0.1 M Phosphate/Citric acid, pH 9.5	15 mL
*4-Methylumbelliferyl- α -D-mannopyranoside (dissolve first in 0.25 mL DMSO)	6.5 mg (1/4 EVU)
*Agar 2.0%	10 mL
Incubate at 37°C, until sufficient activity is visible under long-wave (365 nm) UV light.	

Phosphoglycerate kinase monomer	PGK E.C. 2.7.2.3
0.2 M Tris/HCl, pH 8.0	15 ml
1.0 M MgCl ₂	1 mL
ATP	14 mg (1 EVU)
3-Phosphoglyceric acid (sodium salt)	55 mg (1 EVU)
*NADH	30 mg (3 EVU)
*GAPDH	375 units
*Triosephosphate isomerase	300 units
*Glycerol-3-phosphate dehydrogenase	75 units
*Agar 2.0%	10 mL
Incubate at 37°C, until sufficient activity is visible under long-wave (365 nm) UV light.	
Pyruvate kinase tetramer	PK E.C. 2.7.1.40
0.2 M Tris/HCl, pH 8.0	15 mL
ADP	14 mg (1 EVU)
Fructose-1, 6-diphosphate	7 mg (1/4 EVU)
1.0 M MgCl ₂	0.5 mL
Potassium chloride	165 mg (3 EVU)
Phospho(enol)pyruvate	12 mg (1 EVU)
*NADH	30 mg (3 EVU)
*LDH	400 units
*Agar 2.0%	10 mL
Incubate at 37°C, until sufficient activity is visible under long-wave (365 nm) UV light.	

Miscellaneous Stains

Adenosine deaminase monomer	ADA E.C. 3.5.4.4
0.1 M Phosphate, pH 8.5	15 mL
Arsenic acid (sodium salt)	50 mg (1 EVU)
Adenosine	3 mg (1/4 EVU)
*XO	3 units
*Purine-nucleoside phosphorylase	5 units
*MTT 0.5%	0.5 mL
*PMS 0.5%	0.5 mL
*Agar 2.0%	10 mL
Incubate at 37°C in the dark until sufficient activity is present.	

Aspartate aminotransferase dimer	AAT E.C. 2.6.1.1
0.12 M Tris, 0.02 M Citric acid, 2.4 mM Lithium hydroxide, 12.0 mM Boric acid (TBCL gel buffer diluted 2 in 5, see Appendix 1), 0.22% α -Ketoglutaric acid, 0.5% L-Aspartic acid, pH 7.5 (adjust pH with 3.0 M Potassium hydroxide)	15 mL
*Fast blue BB salt	17 mg (1/2 EVU)
*Agar 2.0%	10 mL
Incubate at 37°C in the dark until sufficient activity is present.	

Carboxylesterase subunit structure variable¹	EST E.C. 3.1.1.1
0.1 M Phosphate, pH 7.0	75 mL
* α -Naphthyl propionate (dissolve first in 4.0 mL acetone)	12.5 mg (1/2 EVU)
*Fast blue BB salt	34 mg (1 EVU)
Place gel slab in a staining tray, pour staining solution into tray, then agitate tray to loosen gel slab from the bottom of tray.	
Incubate at 22°C until sufficient activity is present, pour off the staining solution, and rinse the gel slab in water.	
Other possible substrates are α -Naphthyl acetate and α -Naphthyl butyrate.	
¹ This stain detects a class of enzymes which does not represent a single ancestral lineage; therefore subunit structure may vary among loci.	
Catalase tetramer	CAT E.C. 1.11.1.6
Hydrogen peroxide 0.06%	10 mL
Apply to filter paper overlay as needed to keep moist and incubate at 22°C for 5 min; remove filter paper, soak up excess H ₂ O ₂ solution, and add the following:	
*Potassium ferricyanide 2.0% (make the same day as used)	7 mL
*Ferric chloride 2.0% (make the same day as used)	7 mL
*Agar	10 mL
Appears immediately as yellow zones on blue-green background.	
Diaphorase subunit structure uncertain	DIA E.C.*.*.*.*¹
0.2 M Tris/HCl, pH 8.0	13 mL
2, 6-Dichlorophenol-indophenol 0.02% in 0.2 M Tris/HCl, pH 8.0	2 mL
*FAD	2 mg (1/8 EVU)
*NADH or NADPH	7.5 mg (1/2 EVU)
*MTT 0.5%	2 mL
*Agar 2.0%	10 mL
Incubate at 37°C in the dark until sufficient activity is present.	
¹ This stain may detect Xanthine oxidase or a variety of other enzymes.	

General protein stain	GP
Glacial acetic acid	1 part
Ethyl alcohol 100%	5 parts
Distilled water	4 parts
Naphthol Blue Black 1%	
Nigrosin 1%	
Place gel slab in a staining tray, pour enough staining solution into the tray to cover the gel (approximately 75 mL), and then agitate the tray to loosen the gel slab from bottom of the tray.	
Incubate at 22°C for approximately 15 min, then pour the staining solution off (save for repeated use), rinse gel slab with water, and then cover with destain solution (first three items).	
Change the destain periodically, as it turns blue, until all excess stain has been removed.	
β-Glucuronidase tetramer	βGUS E.C. 3.2.1.31
0.2 M sodium acetate/HCl, pH 5.0	15 mL
*Naphthol-AS-BI- β -D-glucuronide	10 mg (1/2 EVU)
*Fast garnet GBC salt	10 mg (1/2 EVU)
*Agar 2.0%	10 mL
Incubate at 37°C in the dark until sufficient activity is present.	
Glutathione reductase dimer	GR E.C. 1.6.4.2
0.2 M Tris/HCl, pH 8.0	13 mL
2, 6-Dichlorophenol-indophenol 0.02% in 0.2 M Tris/HCl, pH 8.0	2 mL
Glutathione (oxidized)	18 mg (1 EVU)
*FAD	2 mg (1/8 EVU)
*NADH	7.5 mg (1/2 EVU)
*MTT 0.5%	2 mL
*Agar 2.0%	10 mL
Incubate at 37°C in the dark until sufficient activity is present.	
Guanine deaminase dimer	GDA E.C. 3.5.4.3
0.2 M Tris/HCl, pH 8.0	15 mL
Guanine 2.0% in 1.0 M NaOH	0.1 mL
*XO	3 units
*MTT 0.5%	0.5 mL
*PMS 0.5%	0.5 mL
*Agar 2.0%	10 mL
Incubate at 37°C in the dark until sufficient activity is present.	

Lactoyl-glutathione lyase dimer	LGL E.C. 4.4.1.5
0.1 M Phosphate, pH 7.0	15 mL
Methyl glyoxal	1.0 mL
Glutathione (reduced)	48 mg (2 EVU)
Mix above items, apply to filter paper overlay as needed to keep moist, and incubate at 37°C for at least 45 min; remove filter paper and add the following:	
*Iodine 2.0%/Potassium iodide 4.0% (make the same day as used)	1.0 mL
*Agar 2.0%	24 mL
Appears immediately, then fades.	
Nucleosidetriphosphate pyrophosphatase dimer	NTP E.C. 3.6.1.19
0.2 M Tris/HCl, pH 8.0	15 mL
1.0 M MgCl ₂	1 mL
2-Mercaptoethanol	0.12 mL
Inosine triphosphate	24 mg (1 EVU)
Mix above items, apply to filter paper overlay as needed to keep moist, and incubate at 37°C for at least 1 h; remove filter paper and add the following:	
*Molybdc acid (ammonium salt) 2.5% in 2.0 M sulfuric acid	12 mL
*Ascorbic acid (sodium salt)	500 mg
*Agar 2.0%	12 mL
Incubate at 37°C in the dark until sufficient activity is present.	
Peptidase subunit structure variable¹	PEP E.C. 3.4.*.*
0.1 M Phosphate, pH 7.5 (use pH 6.5 for L-Phenylalanyl-glycyl-L-phenylalanine peptide)	15 mL
0-Dianisidine (dihydrochloride)	6 mg (1/4 EVU)
Snake venom (Western Diamondback Rattlesnake)	4 mg (1/4 EVU)
Peroxidase	2 mg (1/2 EVU)
*Peptide substrate. e.g., Glycyl-L-leucine, DL-Leucylglycylglycine, L-Leucyl-L-tyrosine, L-Phenylalanyl-L-proline, L-Phenylalanyl-glycylglycyl-L-phenylalanine	
*Agar 2.0%	10 mL
Incubate at 37°C in the dark until sufficient activity is present.	
¹ This stain detects a class of enzymes which does not represent a single ancestral lineage; therefore subunit structure may vary among loci.	

Purine-nucleoside phosphorylase trimer	PNP E.C. 2.4.2.1
0.1 M Phosphate, pH 8.5	15 mL
Arsenic acid (sodium salt)	50 mg (1 EVU)
Inosine	72 mg (3 EVU)
*XO	3 units
*MTT 0.5%	0.5 mL
*PMS 0.5%	0.5 mL
*Agar 2.0%	10 mL
Incubate at 37°C in the dark until sufficient activity is present.	
Superoxide dismutase dimer¹	SOD E.C. 1.15.1.1
0.2 M Tris/HCl, pH 8.5	15 mL
*MTT 0.5%	0.5 mL
*PMS 0.5%	0.5 mL
*Agar 2.0%	10 mL
Incubate at 37°C in the dark until activity just begins to appear and then set in indirect light until sufficient activity is present.	
¹ The mitochondrial form of this enzyme is a tetramer.	
Xanthine oxidase subunit structure uncertain	XO E.C. 1.2.3.2
0.2 M Tris/ HCl, pH 8.0	15 mL
Hypoxanthine 4.0% in 1.0 M NaOH	0.2 mL
*MTT 0.5%	0.5 mL
*PMS 0.5%	0.5 mL
*Agar 2.0%	10 mL
Incubate at 37°C in the dark until sufficient activity is present.	

APPENDIX 2: Electrophoresis buffers

Following are recipes for our three most commonly used gel buffers. The first two are continuous buffer systems (where components of the gel buffer are the same as components of the electrode buffer), and the third is a discontinuous buffer system (where components of the gel buffer are different than components of the

electrode buffer). Recipes for the buffers are presented in units of molarity (M) or moles per liter. To calculate the number of grams of a chemical required in a specific volume of buffer, multiply the molarity (m/L) times the formula or molecular weight (g/m) of the chemical times the desired volume (L).

AC : Amine, Citric acid buffer (Clayton and Tretiak 1972)

Electrode, pH 7.0*:

Citric acid 0.04 M
N-(3-aminopropyl)-morpholine: add until pH is reached
EDTA¹ (optional) 0.01 M

Gel: use 1 in 20 dilution of the electrode buffer.

*For certain circumstances where it is desirable to have the locus of interest migrate more toward the cathode, a pH of 6.0 or 6.5 is sometimes used.

¹Ethylenediaminetetraacetic acid (sodium salt).

TBE : Tris, Boric acid, EDTA buffer (Boyer et al. 1963)

Electrode, pH 8.7:

Tris 0.18 M
Boric acid 0.1 M
EDTA 0.004 M

Gel: use 1 in 4 dilution of the electrode buffer.

TBCL: Tris, Citric acid gel buffer/Lithium hydroxide, Boric acid electrode buffer (Ridgway et al. 1970)

Electrode, pH 8.0:

Lithium hydroxide 0.06 M
Boric acid 0.3 M
EDTA (optional) 0.01 M

Gel, pH 8.7:

Tris 0.3 M
Citric acid 0.05 M
Add 10% of the electrode buffer.
Use 1 in 10 dilution of the gel buffer.

