

# Physical Properties of Blue Shark Useful in Designing a Skinning Machine

D. E. BROWN, R. PAUL SINGH, R. E. GARRETT, and BARBARA KATZ

## Introduction

Sharks are among the most ancient and notorious of the fishes living today in the world ocean. Despite their "man-eating" reputation, catching shark for human consumption is a long-standing and worldwide practice. A record 10.2 million kg (22.6 million pounds) of shark were landed by U.S. commercial fishermen in 1979 (NOAA, 1980).

Blue shark, *Prionace glauca*, found in abundance in the waters off southern California, is considered an underutilized food source. Further, blue sharks are considered a pest by most commercial and sport fishermen. They are often caught incidentally with squid, a main component of the blue shark diet. They are considered a migratory, pelagic species.

Longlining is one method used to catch blue sharks. The authors observed this technique (Fig. 1) aboard the commercial fishing vessel *JJ*. In this labor-intensive operation, over 250 hooks are baited and clipped to a stainless steel line. The line, set for up to 5 hours while the boat drifts on the open sea, takes blue sharks from 1.2 to 2.5 m (approximately 4-8 feet) in length. The line is then winched back aboard and the sharks are removed from the line, gaffed, and restrained manually on a gutting table.

D. E. Brown is Junior Development Engineer, R. Paul Singh is Associate Professor, and R. E. Garrett is Professor and Chairman, Department of Agricultural Engineering, University of California, Davis, CA 95616. Barbara Katz is University of California Sea Grant Area Marine Advisor, California State University Long Beach, Long Beach, CA 90840.

The tail is severed to bleed the shark and the fins are removed with a knife. The shark is then gutted and headed and the unskinned carcass is dropped into the hold and chilled with a cold saltwater spray. Then the longline is winched again and the next shark is removed from the line.

Commercial fishermen received \$0.59-0.66/kg (\$0.27-0.30/pound) in October 1980 for the unskinned blue shark carcasses at San Pedro, Calif. These are then sliced into fillets and each piece is skinned. It is estimated that 30-50 percent of the meat is lost when the shark steaks are skinned by the processor<sup>1</sup>. The fins, also valuable, are dried and shipped to the Orient for shark-fin soup.

Despite the unpopularity of shark

meat in North America, members of the seafood industry feel there is a great need for a machine to skin blue shark<sup>2</sup>. A wider market for blue shark products is being sought. For example, if removed in one piece the skin is of value for making leather. The machine proposed to skin blue shark could aid its use for meat, fins, and hide and turn a former pest into a viable commercial fishery.

## Design Parameters

Ocean Leather Corporation<sup>3</sup>, Newark, N.J., has been converting shark skins into leather for shoes and other prestigious leather goods since 1922 (Brody, 1965). The required hide shape

<sup>1</sup>C. Christen, *FV JJ*, Terminal Island, Calif. Pers. commun., 1979.

<sup>2</sup>Gary, R. L., Sun Harbor Industries, San Diego, Calif. Pers. commun., 1979.

<sup>3</sup>Mention of trade names or commercial firms does not imply endorsement of the National Marine Fisheries Service, NOAA.

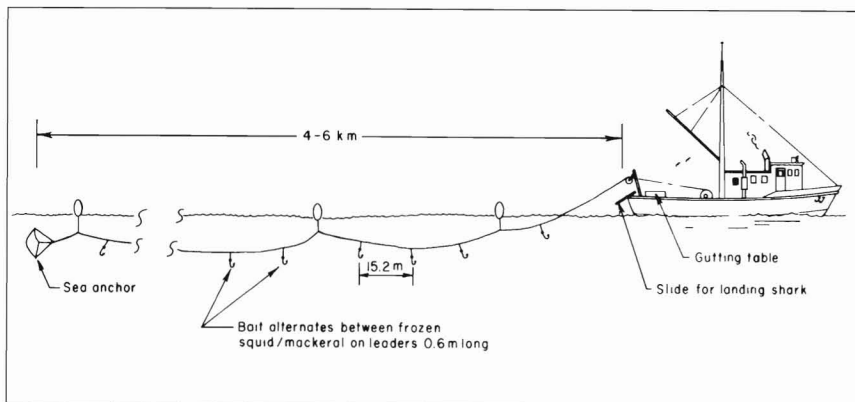

Figure 1.—Longline fishing method for blue shark as practiced on the commercial fishing vessel *JJ*.

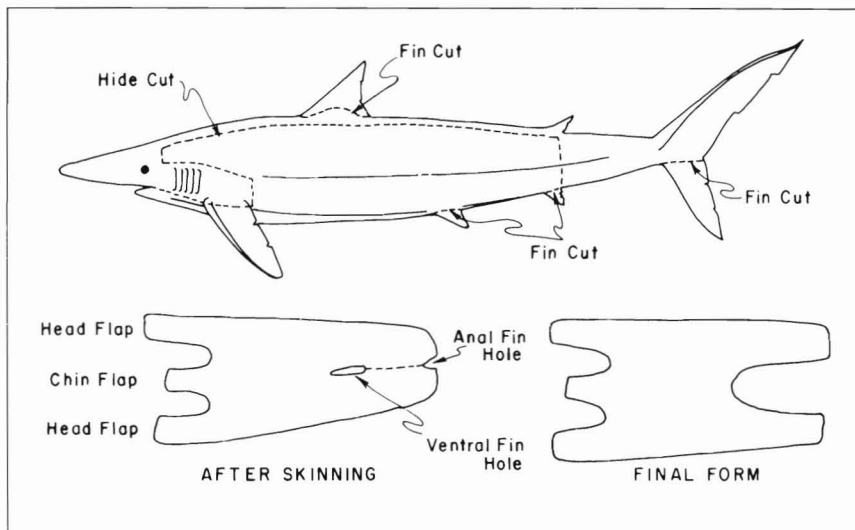

Figure 2.—Required form of blue shark hide after skinning (adapted from Ocean Leather Corp.).

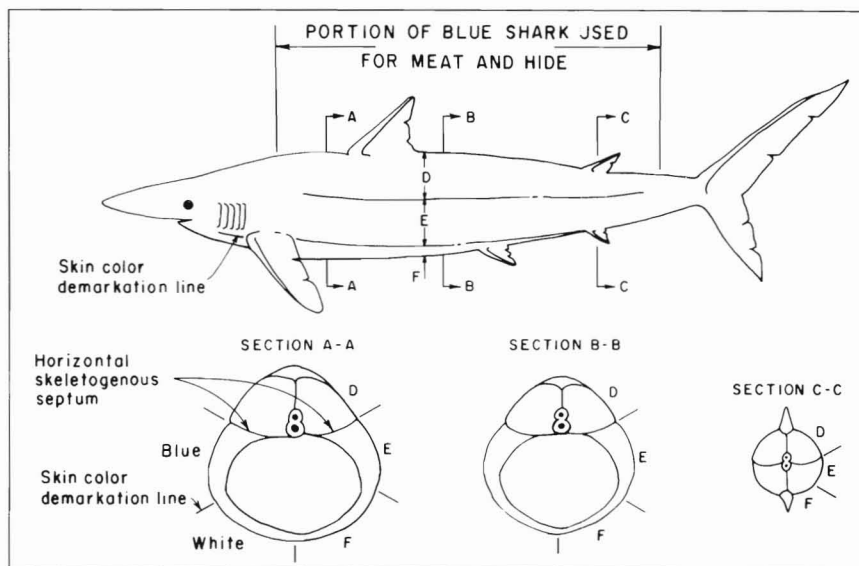

Figure 3.—Sample positions used in determining physical properties of blue shark skin and flesh.

is shown in Figure 2. Other requirements include that hides be at least 1.2 m (40 inches) long and free from sour spots (decomposition), butcher cuts (knife cuts made while skinning), fighting scars, and burnt spots (prolonged exposure to sun before processing). To insure

top quality, the hide should be removed as quickly as possible. Hides cannot be frozen or exposed to fresh water without causing wrinkles. They must be fleshed (excess meat removed), salted or pickled for preservation, and packed for shipment.

To provide high quality blue shark products and be compatible with existing fishing techniques, a shark skinning machine would have to be mounted on the fishing vessel. The shark could then be processed immediately. The shark would have to be restrained and killed prior to processing because they are capable of violent movements for up to 40 minutes after landing.

The primary objective of this paper was to determine physical properties of the blue shark important in the design and development of a skinning machine. We further suggest a prototype skinning machine for this species.

### Experimental Procedures

#### Sample Collection and Preparation

Three frozen blue sharks were donated by the commercial fishing vessel *JJ* for our tests. Head, fins, viscera, and tails had been removed prior to shipment. Overall length of the sharks ranged from 1.2 to 1.8 m (4 to 6 feet).

Shark carcasses were thawed at room temperature and samples of skin or flesh were cut at or near (up to 15 cm anterior and posterior) cross sections A, B, and C shown in Figure 3. These sample sections were further differentiated into parts D, E, and F. Part D denotes skin and flesh samples on the dorsal side of the horizontal skeletogenous septum. Position E samples were taken from the ventral side of the horizontal skeletogenous septum above the skin color demarkation line. Position F samples consist of the white skin of the ventral surface and the flesh it covers. Samples were taken from either side of the horizontal skeletogenous septum because of the difficulty it caused in preparing samples.

Each shark was split from head to tail with the shark's right side used for longitudinal skinning and flesh experiments (Fig. 3). The shark's left side was used for radial or dorsoventral experiments. Samples of flesh and skin were cut (Fig. 4a, b) so that the direction of movement of plane of the blade of the Warner-Bratzler-type shear press was parallel to the longitudinal axis or radial to the longitudinal axis as it applied a shear force (Fig. 5). The tensile forces,  $F_t$ , applied

by the Instron Universal Testing Machine (Fig. 6) to the flesh and skin samples (Fig. 4c, d) were also applied parallel to the longitudinal axis or from dorsal to ventral. The samples used to determine the adhesive work (force required  $\times$  distance pulled) required to separate the skin from the flesh (Fig. 4e) were cut so that the skin could be peeled both from head to tail (longitudinally) or from dorsal to ventral.

Two samples of each of the five noted in Figure 4 were taken from each section and position on the three shark carcasses, with the exception of the flesh tensile tests. Because of the thin cross section of the shark flesh and the adherence of the pleuroperitoneal cavity membrane at F (Fig. 3) and the "grain" of the meat at position D (Fig. 3), flesh tensile samples were difficult to prepare.

### Apparatus and Measurements

Tests to determine tensile strength and breaking elongation (ultimate elongation) of blue shark flesh and skin, and the effort required to separate the skin from the flesh (adhesion work) were performed on an Instron Universal Testing Instrument (Model TM-M, Instron Engineering Corp., Canton, Mass.). The instrument was operated in a tensile mode with a crosshead velocity of 50 cm/minute, with a chart speed of 100 cm/minute, a 50 kg tension load cell, and jaw-type fixtures.

A Warner-Bratzler-type shear press, built by the Food Science Department, University of California Davis, was used to determine the shear strength and shear work of blue shark flesh and skin. The shear blade was mounted in the crosshead of the Instron Testing Instrument and the anvil, against which the blade shears the shark samples, rests on the Instron's 50 kg compression load cell (Fig. 5). Crosshead speed remained 50 cm/minute and chart speed 100 cm/minute. The equation used to calculate shear strength,  $S$ , for this type of double shear is described by Mohsenin (1970):

$$S = \frac{F_s}{2A}$$

where  $F_s$  is the maximum force recorded by the Instron (Fig. 7b) and  $A$  is the

Figure 4.—Sectioning of blue shark samples: (a) and (c) flesh; (b) and (d) skin; (e) peel test of skin from flesh.

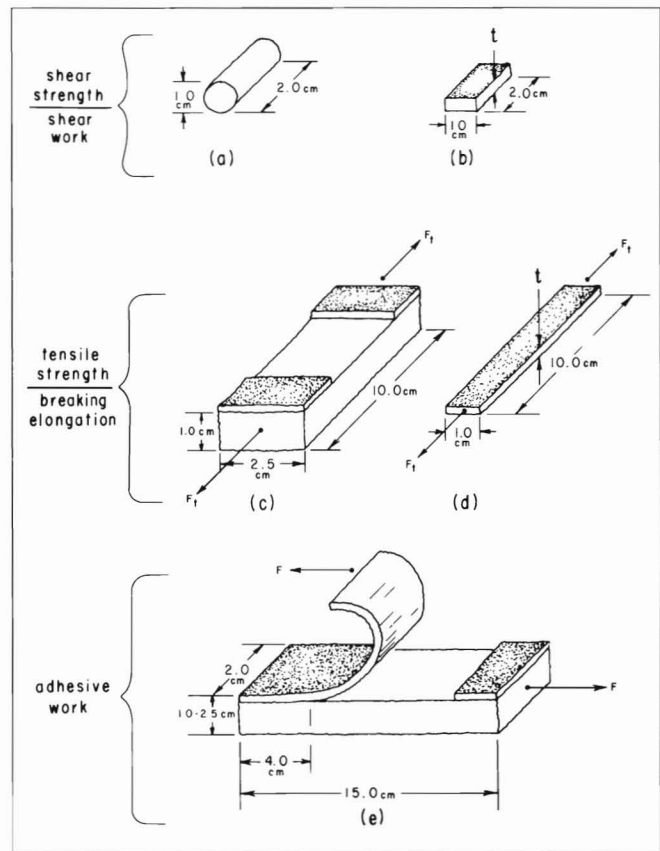

cross-sectional area of the shark sample. Shear work is represented by the area under the force-distance curves generated by the Instron (Fig. 7b).

Tensile strength and breaking elongation of flesh and skin were measured with the samples of skin and flesh held in the jaw fixtures (Fig. 6). The crosshead moved upward until the sample ruptured. The maximum force was recorded for calculation of tensile strength,  $T$ , and the distance the crosshead traveled for calculation of breaking elongation. A schematic representation of the Instron output is shown in Figure 7a.

Tensile strength is defined by the following equation:

$$T = \frac{F_t}{A}$$

where  $A$  is the original cross-sectional area of the skin or flesh sample. The percent elongation after fracture of the

skin and flesh samples is given by the equation:

$$\frac{I_f - I_i}{I_i} \times 100,$$

where  $I_i$  is the initial length of the sample and  $I_f$  is the final length as the sample ruptures.

Adhesive work was determined by performing a modified T-peel test, ASTM D1876-61T (Cagle, 1968). The shark peel test specimens are seen in Figure 4e and in the jaws of the Instron in Figure 8. With the Instron in a tensile mode the crosshead moves upward peeling the skin from the flesh. Figure 7c gives a schematic representation of the Instron output for the adhesive work tests. Adhesive work is represented by the area under the force-distance curve. The calculated value for adhesive work was then divided by the area of skin removed (Figure 4e).



Figure 5.—Warner-Bratzler-type shear press and sample of blue shark flesh.

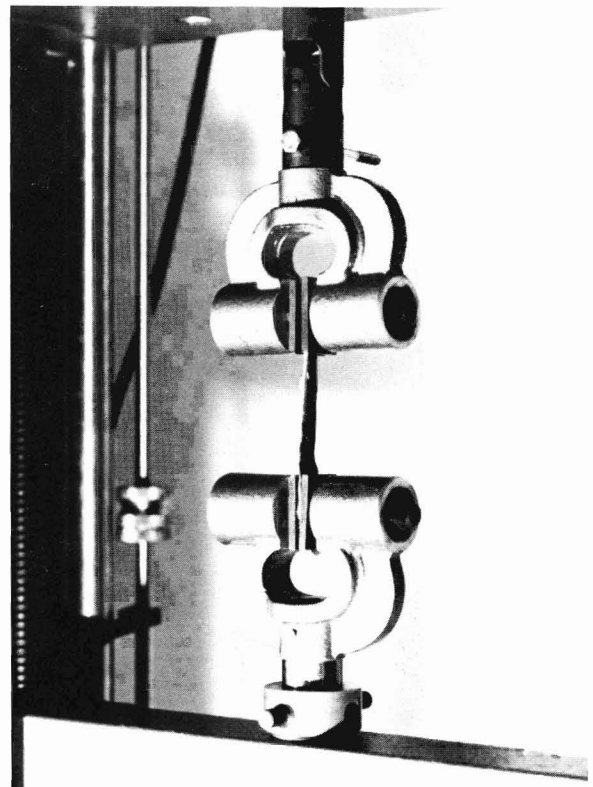

Figure 6.—Tensile test of blue shark skin mounted in jaws of Instron Universal Testing Machine.

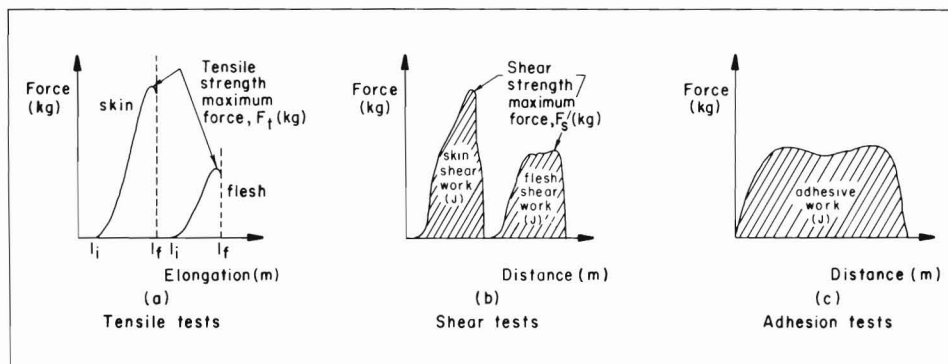

Figure 7.—Schematic force-distance curves: (a) tensile, (b) shear, (c) adhesion tests.

## Results and Discussion

### Tensile Strength and Breaking Elongation

The range of recorded values for tensile strength of blue shark skin (Fig. 9)

was found to be 2 orders of magnitude greater than the tensile strength of the flesh at sample position b (Fig. 10). The tensile strength of the skin ranged from 3 to 13 MPa. No significant differences appear for tensile strength of skin with

respect to sections A, B, or C or the direction of applied force. The tensile strength of shark skin at sample position F does tend to be higher than those for positions D and E. This is despite the fact that the white skin at position F

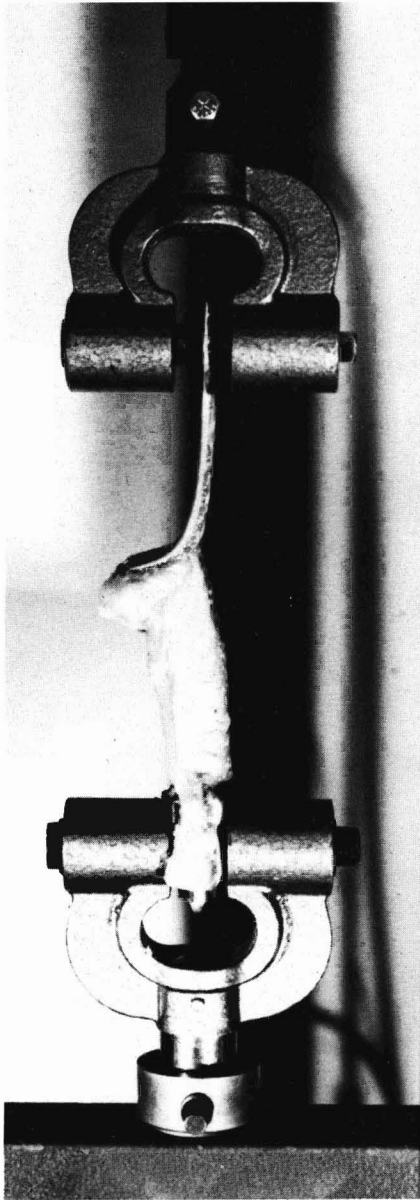

Figure 8.—Blue shark sample ready for adhesion testing in Instron Universal Testing Machine.

(ventral surface) is quite thin and supple.

Breaking elongation of blue shark skin varied from 70 to 240 percent (Fig. 9). The majority of skin samples tested stretched over 100 percent before breaking. Breaking elongation of blue shark flesh at position E, along the longitudinal axis, ranged from 20 to 100 percent (Fig. 10).

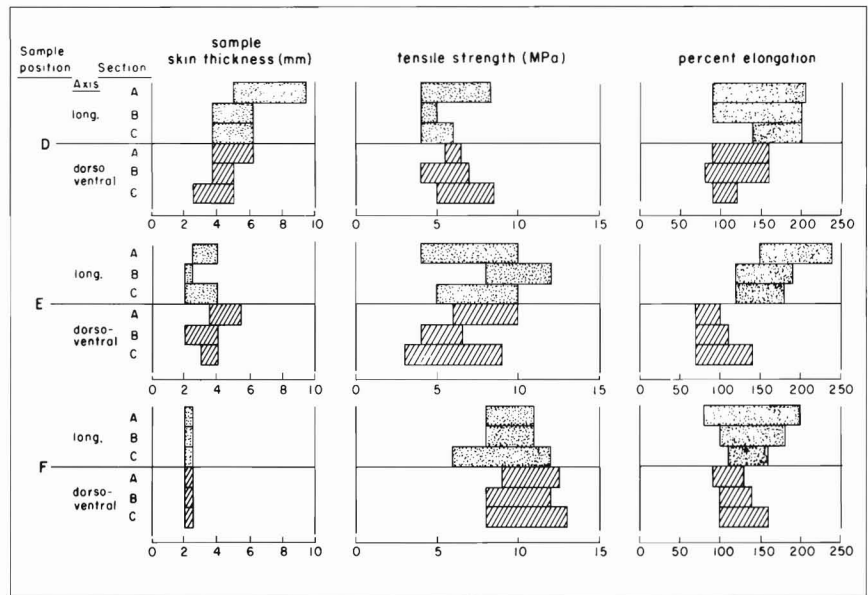

Figure 9.—Tensile strength and breaking elongation of thawed blue shark skin (Instron Universal Testing Machine).

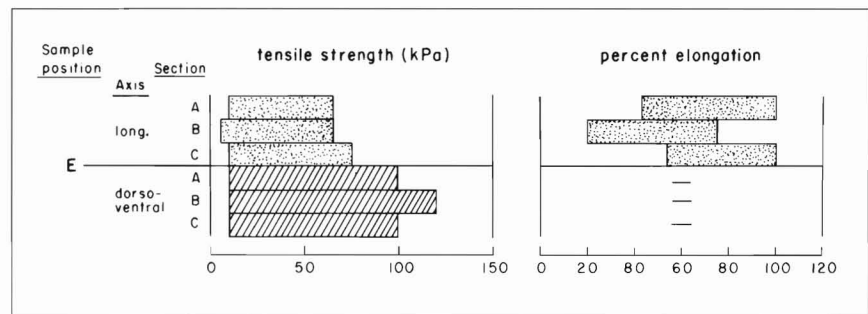

Figure 10.—Tensile strength and breaking elongation of thawed blue shark flesh (Instron Universal Testing Machine).

### Shear Strength and Shear Work

Figures 11 and 12 show the range of shear strength and shear work recorded for skin and flesh, respectively. Using the Warner-Bratzler-type shear press, the shear strength of the blue shark skin, 1.5-12.5 MPa, was found to be at least 20 times greater than that of the flesh, 30-600 kPa. The shear strength of the dorsally located skin, position D, tended

to be less than that for the ventral surface, position F. The range of values recorded for shear work (area under force-distance curve), at position D, the dorsal area, are 2-6 J. Because of the greater thickness of the dorsal skin, the shear work has the tendency to be higher than for position E, 1-4 J, and the ventral surface, position F, 0.5-4.5 J. Little variance was found in shear strength or shear work of skin with respect to section or direction of applied force.

The range of shear work recorded for blue shark skin, 0.5-6.0 J, was 3-50 times greater than that for flesh (0.01-2.2 J).

### Adhesive Work

The range of values recorded for adhesive work, pulling skin from flesh, in the blue shark samples tested was 0.2-3.2 kJ/m<sup>2</sup> (Fig. 13). The highest values recorded occurred when peeling the skin covering the tail of the shark, section C, parallel with the longitudinal axis. In general, the adhesive work required to peel the shark from dorsal to ventral was lower. Stretching of skin during peeling was negligible. These two facts could be of some advantage when skinning the shark in the manner proposed.

### A Skinning Machine Design

As noted, the effort required to skin blue shark from dorsal to ventral surface was lower than that for the longitudinal direction. It was also observed by the authors that the amount of meat remaining on the skin after the dorsal to ventral peel tests was less than that for the longitudinal tests. The amount of meat remaining after the peel tests was also lower than that left when shark skin is pared from the flesh manually with a knife. If the skins are removed by pulling, from dorsal to ventral surface, it would be easier to flesh the hide. These observations, plus the requirement by processors that no butcher cuts be made in the hide, make it advantageous to peel the skin from the shark rather than cut it away from the flesh.

The authors envision a machine, on board ship (Fig. 14), which would restrain the shark initially in a retractable cage as the shark is landed. The shark, restrained by the bars of this cage which have a wide enough spacing to allow the caudal and dorsal fins to protrude (Fig. 15A), is conveyed to a skinning and gutting station on the ship. The cage and shark are then rotated on their longitudinal axis so that it can be restrained with a row of spikes or augers mounted on a rigid beam (Fig. 15B). These would penetrate the dorsal surface of the shark, after removal of the dorsal fin, and into the spine, skull, and brain. The spine and skull of blue shark is easily

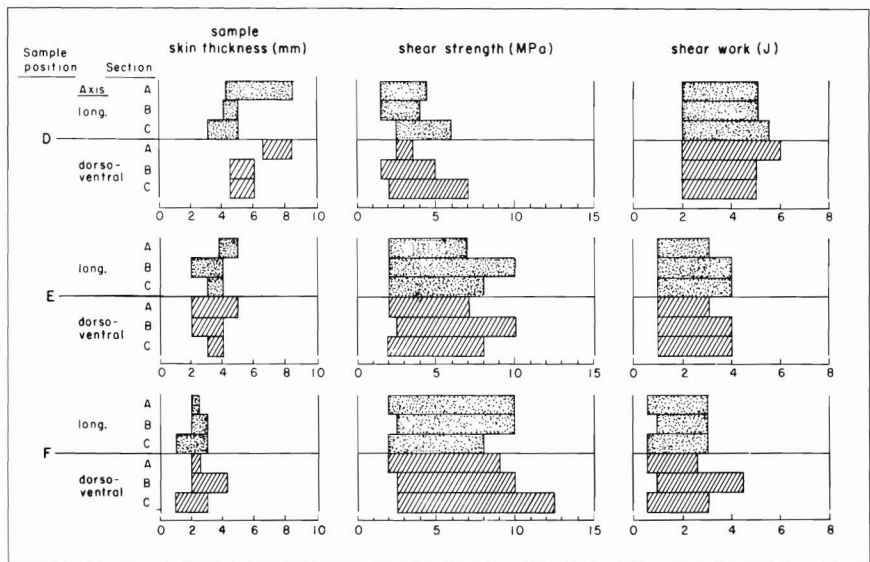

Figure 11.—Shear strength and shear work of thawed blue shark skin (Warner-Bratzler-type shear press).

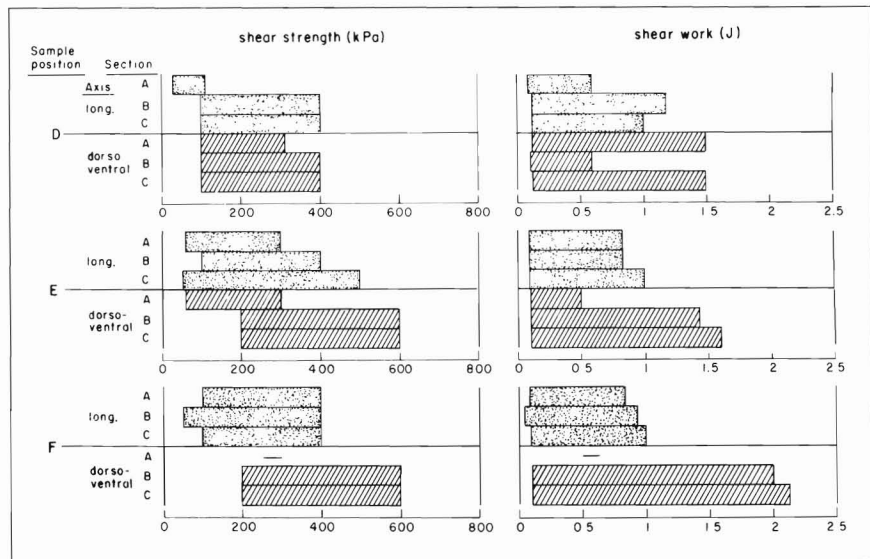

Figure 12.—Shear strength and shear work of thawed blue shark flesh (Warner-Bratzler-type shear press).

penetrated. This would effectively kill the shark and reduce the nervous activity and movements of the shark<sup>4</sup> which

<sup>4</sup>Nelson, D. R., California State University, Long Beach, Calif. Pers. commun., 1980.

would otherwise interfere with the skinning process and hide quality. Although the hide has been ruptured on the dorsal side, the desired form of the hide is still intact. The caudal and pectoral fins could then be removed and saved, and



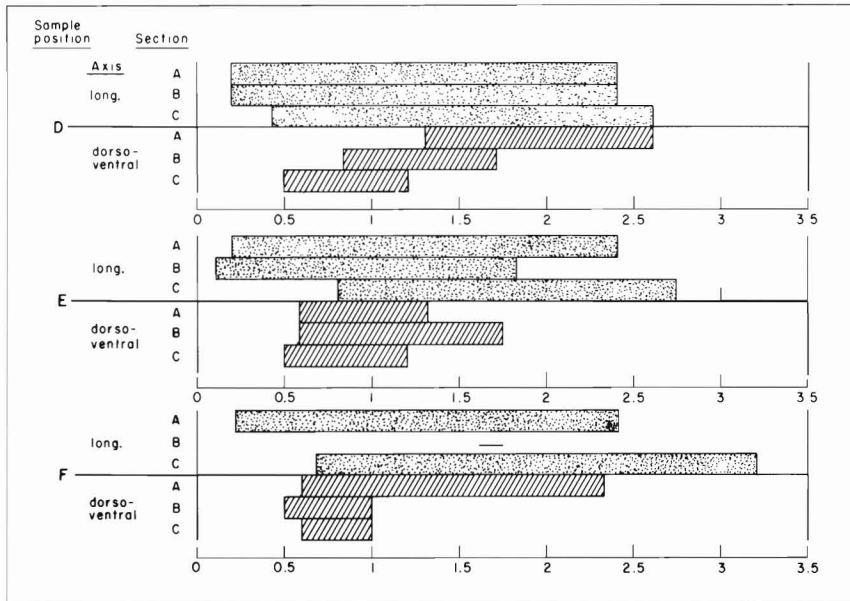

Figure 13.—Adhesive work required to skin thawed blue shark (Instron Universal Testing Machine) ( $\text{kJ/m}^2$ ).

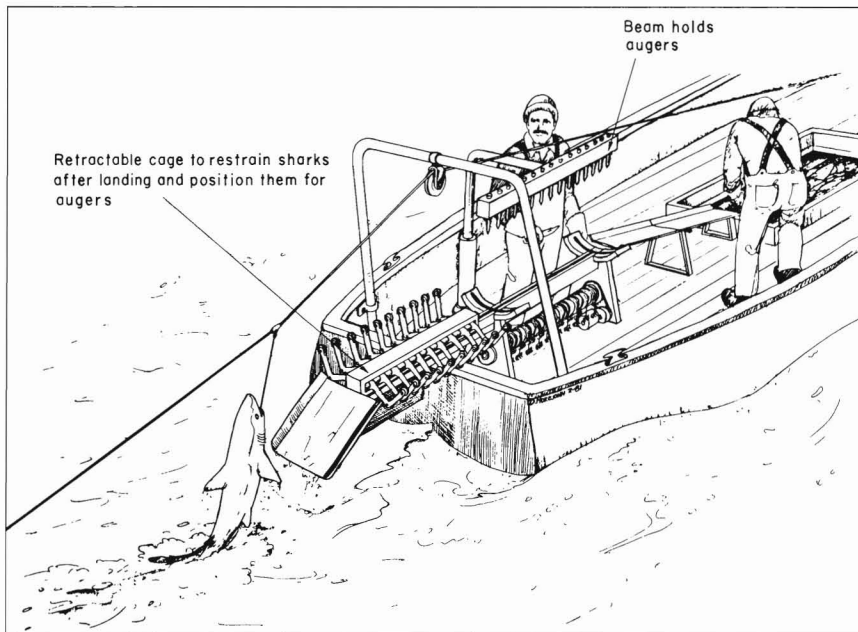

Figure 14.—Proposed blue shark skinning machine onboard ship using longline fishing technique.

the tail can then be severed, thus bleeding the shark.

A hand operated knife (Fig. 16) used

to open deer carcasses for gutting, by cutting from the inside, was successful in making the full-length dorsal cut. A

tool of this type could mechanically follow the row of restraining spikes proposed above along the dorsal ridge of the shark to start the skinning process (Fig. 15C). This hide cut (Fig. 2) would be made on the left and right hand sides of the dorsal ridge as close to its apex as possible. Because of the toughness of the hide, replaceable or disposable blades would be required.

Skin grippers of the type commercially used to manually remove strips of skin from dogfish sharks (Atlas, 1978) could be modified to grip the blue shark skin at the incisions along the dorsal ridge described above (Fig. 15C). Cables attached to these grippers could then mechanically pull the skin away from the flesh (Fig. 15D), around to the ventral side, and off the carcass (Fig. 15E). The hide could then be fleshed and trimmed to the form of Figure 2. The carcass would then be gutted and put in cold storage.

However, the horizontal skeletogenous septum (Fig. 3) may have to be severed from the inside of the skin. The adhesive work required at its point of attachment to the skin was found to be 2-3 times that at other points on the body. The shear work required to sever it is approximately equal to that for the skin on the dorsal surface. The knife-type tool (Fig. 16) could be reinserted to make the cut along the horizontal skeletogenous septum. Such a knife would minimize the risk of making butcher cuts in the hide.

### Summary and Conclusions

The tensile strength of blue shark skin ranges from 3 to 13 MPa and is 2 orders of magnitude greater than that of the flesh. Shear strength of the skin was approximately equal to the tensile strength of the skin and ranged from 1.5 to 12.5 MPa. Shear strength of the skin was 20 times greater than that of the flesh.

Shear work for blue shark skin ranged from 0.5 to 6.0 J and was 3-50 times greater than that for the flesh. The adhesive work required to peel the skin from the flesh of blue shark ranged from 0.1 to 3.2  $\text{kJ/m}^2$ . Less work was required to peel the shark from dorsal to ventral side.

In conclusion, a machine could be

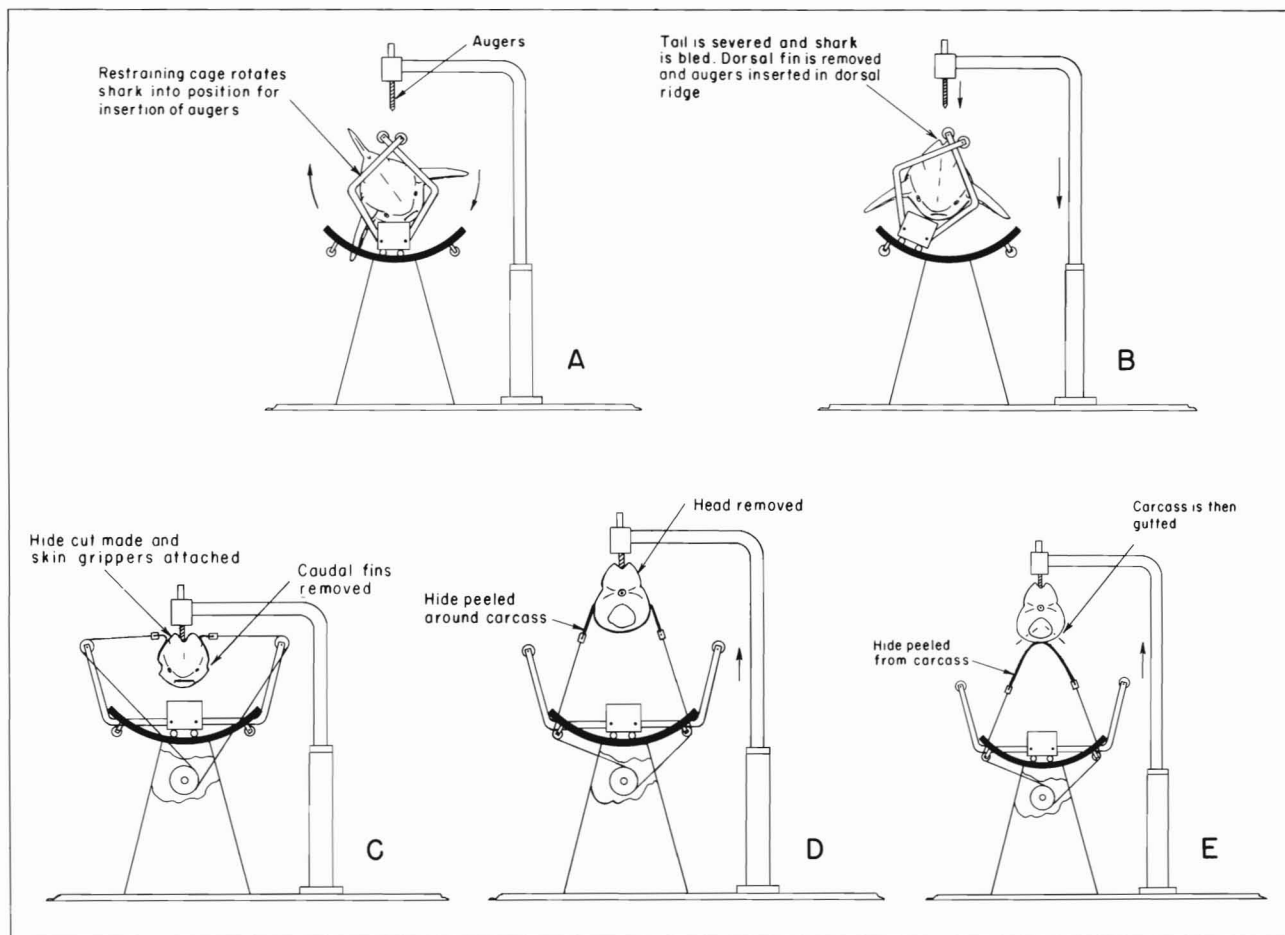

Figure 15.—End view of proposed skinning machine for blue shark.

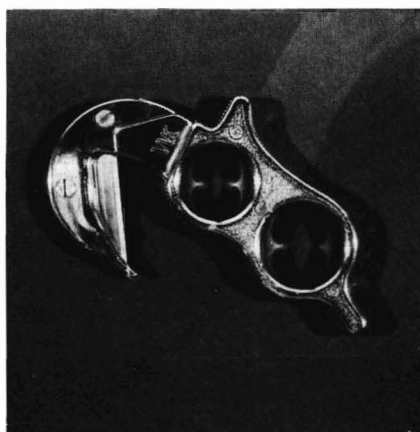

Figure 16.—Field Dressing Knife, Wyoming Knife Corp., Casper, Wyo.

built to pull the skin from the blue shark in one piece, as a commercial means of skinning the shark, by pulling from dorsal to ventral surface.

#### Acknowledgments

This investigation was part of the study "Feasibility of Mechanical Skinning of Blue Shark" supported by Sea Grant, NOAA, U.S. Department of Commerce. The authors wish to thank the captain, John Christen, and crew member, Jane Meyer, of the fishing vessel *JJ* for their generous hospitality and assistance during our stay on their vessel and for providing us with sharks for this study. Contributions of James L. Bum-

garner, University of California, Davis, and Dwight Morejohn, Davis, Calif., in preparing the figures is gratefully appreciated.

#### Literature Cited

- Atlas, M. 1978. Development of processes for skinning the spiny dogfish shark. Master's Thesis, Massachusetts Institute of Technology, Cambridge, 50 p.
- Brody, J. 1965. Fishery by-products technology. AVI Publishing Company, Inc., Westport, Conn., 232 p.
- Cagle, C. 1968. Adhesive bonding. McGraw-Hill Book Company, N.Y., 351 p.
- Mohsenin, N. 1970. Physical properties of plant and animal materials. Vol. 1, 734 p. Gordon & Breach Science Publ., N.Y.
- NOAA. 1980. Fisheries of the United States, 1979. Curr. Fish. Stat. 8000. U.S. Dep. Commer., Wash., D.C., 131 p.