

ANALOG COMPUTER MODELS OF FISH POPULATIONS

BY RALPH P. SILLIMAN, *Fishery Biologist (Research)*

BUREAU OF COMMERCIAL FISHERIES BIOLOGICAL LABORATORY, SEATTLE, WASH. 98102

ABSTRACT

A modern analog computer, together with an X-Y plotter,¹ provides a means of constructing useful models of commercially exploited fish populations. The model combined conventional exponential fishing and natural mortality rates with a Gompertz curve of growth in weight. By combination of these rates and curve into a single differential equation, survival curves for successive year classes of fish were generated by the computer and plotted by the plotter. Weights for all year classes present in each season were summed graphically. Recruitment was determined from a stock-recruitment curve, set into a function generator of the computer. Yields for each season were calculated by multiplying stock weight by rate of exploitation and were compared with actual yields to test the validity of the models.

Fishery biologists have devoted much effort in determining changes in fish populations as they respond to varying degrees of fishing intensity. Because stocks usually cannot be observed and measured directly, it has been necessary to use data of catch and fishing effort and biological data on relatively small samples of the stocks. These records, plus associated data on the environment, have composed most of the working materials of the fishery biologist. Limited to such materials, the fishery biologist has been forced to proceed largely by inference. There has been no alternative. As work became quantitative, inference came to mean statistical or biometric inference, or a combination of both.

One method of quantitative inference is that of simulation or modeling. Using the best empirical

The technique was demonstrated by use of empirical and hypothetical data for the Atlantic cod (*Gadus morhua*). It is generally applicable to fisheries for which good measures of total catch, growth rate, natural and fishing mortality rates, and stock-recruitment relation are available.

It is important to use reasonable values of biological variables in constructing the models because it was not possible to demonstrate beyond doubt that the set of parameters for any given model provides a unique solution.

Compared with other techniques, the analog-graphic approach offers low cost of equipment, moderate computation speed, ready accessibility of equipment, and good visibility of results during computation. It is limited in accuracy (two or three digits) and in scaling requirements.

data and biological judgment available, the biologist erects hypotheses concerning the additive and subtractive processes affecting the stocks. The former include recruitment, growth, and immigration; the latter, fishing mortality, natural mortality, and emigration. To test the validity of the hypotheses, characteristics of the models based on the hypotheses can be compared with what is known of the real populations. Population models are used for the same purpose as models in ship or power-dam design: experiments are easier, quicker, and cheaper with the model than with the full-scale object. Any tool that will help the biologist in these processes should be valuable. This report describes such a tool in the form of an analog computer technique.

Application of the analog computer as described herein has not, to the best of my knowledge, been made previously. Originality is not claimed, however, for the technique of simulation in general or in

NOTE.—Approved for publication Nov. 23, 1965.

¹ Trade names referred to in this publication do not imply endorsement of commercial products.

the field of fisheries. Familiar applications outside the field of biology include aircraft and spacecraft design, ballistic studies for military services, and management of systems such as power-generating pools and nuclear reactors. Among biologists, the ecologists especially have made use of simulation. Notable examples include the simulation of ecological systems by digital computer (Garfinkel and Sack, 1964) and by analog devices (Odum, 1960 and Margalef, 1962). In fisheries there have been three general types of simulation: analytical, digital, and analog.

Analytical simulation is the oldest and best known. It is so well known that an extensive review is superfluous here. In it the biologist analytically determines the nature of the mathematical relations controlling population structure and population response to exploitation. He then constructs mathematical models which predict what will occur under certain assumed conditions of the fishery and the environment. Most of the classical contributions to fishery dynamics are of this type. They include the work of such authors as Baranov (1918), Russell (1931), Thompson and Bell (1934), Graham (1935), Schaefer (1954), Beverton and Holt (1957), and Ricker (1958). During the history of the analytical technique the complexity and sophistication of the formulations have generally increased; the work of Beverton and Holt unquestionably represents the highest development in this respect to date.

Some of the above authors have also used digital simulation. Thompson and Bell (1934) arithmetically constructed tables to simulate the catch and catch per unit of effort of the Pacific halibut under constant recruitment and certain assumed rates of growth and mortality. They demonstrated a remarkable correspondence between the values predicted by this method and the observed values for certain periods and areas. Ricker (1958) made somewhat similar calculations based on analytical functions and introduced the additional concept of relation between stock size and rate of recruitment. He expressed catches in terms of "equilibrium yields" which would be obtained when the additive processes affecting the populations just balanced the subtractive ones. An outstanding example of digital simulation of a fish stock is found in Larkin and Hourston (1964).

To my knowledge, only Doi (1957, 1962) has proposed application of the analog computer to fishery dynamics. He set forth mathematical formulations

and computer block diagrams and made applications to Japanese fisheries. His formulas are similar to those used here, in general, but differ in detail. He also adapted the Volterra equations to analog treatment of predatory and competitive relations among fish populations.

With some notable exceptions (Ricker, 1958; Larkin and Hourston, 1964; Larkin and Ricker, 1964; International North Pacific Fisheries Commission, 1962), fishery-simulation attempts to date have dealt with equilibrium population conditions. This restriction is understandable in view of the mathematical complexities introduced by varying rates. Such an approach does, however, lead to models which are somewhat unreal compared with their counterparts in nature. For instance the number of recruits annually entering the stocks varies widely. This problem has been treated by considering recruitment constant for short periods (apparently close to the truth for some Pacific halibut stocks during various 8- to 10-year periods between 1918 and 1933) or circumvented by expressing results in terms of "yield per recruit." Likewise, fishing mortality varies with fishing intensity. Any realistic simulation of fished populations over considerable periods requires some provision for changes in recruitment and other vital rates, as can be accomplished on the analog computer. The importance of this problem was recognized by Schaefer and Beverton (1963) who wrote:

"... the characteristics of the recruitment to marine fish populations—its degree of fluctuation, its relation to stock size and the influence on it of changing environmental conditions—are the key to the interpretation and prediction of the long-term dynamics of a fishery . . ."

and:

"Actual fisheries are, however, seldom in steady states . . ."

The remainder of this report is devoted to a description of the plan of attack (Platt, 1964—strong inference) used in the analog computer approach. Briefly outlined, this plan is as follows:

1. Formulation of vital rates in a manner suitable for analog solution, thus setting up a hypothesis.
2. Simulation of populations and yields over the period for which observational data are available.
3. Comparison of simulated and observed yields, testing the hypothesis.

4. Acceptance or rejection of the hypothesis. If the agreement of simulated with observed yields is good, the hypothesis is accepted. If it is rejected, a new hypothesis is erected by adjustment of parameters in the analog model, and steps 2 to 4 are repeated until satisfactory fit of simulated to actual yields is either attained or found unattainable.

In practice, the process was never repeated more than a few times, since improvement fell off rapidly. Also, indefinite repetition would be out of keeping with the scientific method.

BASIC FORMULATIONS

For the initial trials of the analog technique, I adopted what seemed the simplest useful model of a fish population. This model includes rate of growth, rates of fishing and natural mortality, and a recruitment-stock relation. It does not take account of immigration, emigration, or environmental effects. Symbols used have been adapted from Holt, Gulland, Taylor and Kurita (1959) in furtherance of their admirable attempt to secure uniformity in the terminology of fishery dynamics. Definitions are as follows:

- N_t = Number of recruits surviving at time t .
 R = Initial number of recruits to fishable stock for a single year class.
 f = Fishing effort.
 F = Instantaneous rate of fishing mortality.
 q = F/f .
 M = Instantaneous rate of natural mortality.
 Z = $F + M$.
 t = Age of fish in years.
 t_r = Age of fish at recruitment to fishable stock.
 t_c = Age of fish when first vulnerable to capture by gear in use.
 P_t = Weight of all fish of a given year class surviving at time t .
 P_{t_0} = Weight of all fish present at beginning of season.
 w_t = Weight of individual fish at time t .
 w_∞ = Upper asymptotic limit of w_t .
 w_r = Weight of individual recruit at time t_r .
 \hat{Y}_w = Estimated yield of fishable stock in weight, per year.
 Y_w = Actual yield of fishable stock in weight, per year, from official statistics.
 E = Rate of exploitation, = $\frac{F}{F + M} (1 - e^{-(F + M)})$.
 i = Subscript referring to individual year classes.

In addition to the above, the following symbols have been adopted for the formulations here:

- R_w = Initial weight of recruits to fishable stock for a single year class.
 G, g = Constants of Gompertz growth curve.

Because interest in this study is centered on the commercial catch, the model is limited to the fishable sizes and ages of fish. For a year class of fish passing through the fishable stock, numbers of fish surviving may be expressed according to the declining exponential formula, as set forth in Beverton and Holt (1957):

$$N_t = R e^{-(F+M)(t-t_r)} \quad (1)$$

To take account of the growth of individual fish, and to obtain yields in weight for comparison with commercial catches, it is necessary to introduce a formula for weight-at-age. Beverton and Holt employed the von Bertalanffy equation for length-at-age, converting to weight-at-age by means of a cubic length-weight relation. Use of the cubic relation has been shown to lead to considerable error when the real relation between length and weight involves a power of length other than 3 (Paulik and Gales, 1964). Although this difficulty can be overcome by use of the Incomplete Beta Function (Wilimovsky and Wicklund, 1963) in the yield equation, the formulation still is not well adapted to analog computation.

As an alternative to the von Bertalanffy equation, I investigated the characteristics of the equation developed by Benjamin Gompertz. He applied it as an expression of human mortality rates, but various forms of it have since been used as growth curves for both length and weight of animals. Its applicability in this respect was thoroughly discussed by Winsor (1932). In the form used by Weymouth and McMillin (1931), it is seen to be an exponential curve in which the slope declines exponentially. They point out that the *relative* (as opposed to *absolute*) growth of an animal declines with age because of an increasing proportion of inactive material, and other causes. The declining slope of the Gompertz curve is in accord with this phenomenon. Also, it provided a good fit to the empirical data of weight-at-age for several fishes.

Beverton and Holt (1957) rejected the Gompertz curve on the basis that it deals with growth as an additive process only, ignoring the breakdown of protoplasm. The net effect, however, of anabolism and catabolism may well be the kind of declining relative growth described by the Gompertz curve. This curve thus did not appear to be rejected on

biological grounds, and since it was practical for analog computation, I employed it.

It may be noted that growth rates of fish typically decline throughout life and can be represented most simply by a positive instantaneous rate which decreases exponentially with time, as in the Gompertz curve. The relations can be expressed in the following formulas (where G represents the initial exponential growth and g governs the exponential rate of decline):

$$w_t = w_r e^{G e^{-g(t-t_r)}} \quad (2a)$$

$$w_t = w_r e^{G - G e^{-g(t-t_r)}} \quad (2b)$$

This formula can be combined with formula (1) to express total weight of survivors at any time. It is of interest, also, that it has an upper asymptote w_∞ similar to the " L_∞ " of the von Bertalanffy equation. Thus:

$$\text{as } t \longrightarrow \infty, e^{-g(t-t_r)} \longrightarrow 0$$

$$\text{and } e^{-G e^{-g(t-t_r)}} \longrightarrow 1.00$$

so that $w_t \longrightarrow w_r e^G$ as $t \longrightarrow \infty$ from equation (2a) above. The limiting value of this expression is w_∞ . If extended from $w_t = 0$ to $w_t \sim w_\infty$, the Gompertz curve has a point of inflection lacking in the von Bertalanffy curve. This inflection is found in age-weight curves of many fishes. The total weight of survivors from a single year class may be expressed:

$$P_t = w_t N_t \quad (3)$$

Substituting in (3) for w_t and N_t their equivalents in (1) and (2b):

$$P_t = R w_r e^{[G - G e^{-g(t-t_r)}] - (F+M)(t-t_r)}$$

Because I dealt with weight rather than number of recruits, I set

$$R_w = R w_r$$

and obtained as my working equation:

$$P_t = R_w e^{[G - G e^{-g(t-t_r)}] - (F+M)(t-t_r)} \quad (4)$$

For convenience, clarity, and ready comparability with other work, I have dealt with all relationships so far in algebraic form. Although the computer requires differential equations, the differentiation can be performed on the final equation, (4) above.

THE COMPUTER AND PLOTTER

Since analog machines probably are not familiar to most fishery biologists, a brief description seems in order. Modern analog computers (fig. 1) are electronic and perform operations on voltages. The voltage is made numerically equal (analogous) to variables in the problem (e.g., 1 volt = age of fish of 2 years), and component building blocks on the computer perform mathematical operations. Various blocks perform: (1) algebraic summation, (2) multiplication or division by a constant, (3) multiplication and division of two variables, (4) integration, and (5) generation of nonlinear functions. This last building block makes it possible to produce functions if a graph of the function is available even though the equations describing the graph are unknown.

The analog computer is primarily a device for solving differential equations with time as the independent variable. It, therefore, becomes evident that if a biological process can be expressed as a differential equation, the equation can be mechanized by interconnecting analog computer components corresponding to the mathematical operations.



FIGURE 1.—Analog computer and plotter.

Analog computer programming is based essentially on the electrical principle of the feedback loop. For a simple illustration, let us return to the declining exponential curve, as expressed in equation (1). This expression may be further simplified by setting $F+M=Z$, as in international notation and assuming that our measurement of time begins at t_r so that $t_r=0$ and $(t-t_r)=t$. Expression (1) then becomes:

$$N_t = Re^{-Zt}$$

Remembering that the analog computer requires differential expressions, we differentiate the above to find:

$$\frac{dN_t}{dt} = -RZe^{-Zt}$$

As in digital computation, we start with a "block diagram" (ordinarily this step would be omitted in such a simple circuit, but it is shown here to illustrate the process). A few symbols are needed (arrows indicate direction of information flow):

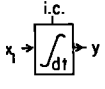
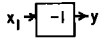
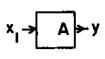
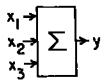
OPERATION PERFORMED BY COMPUTER	SYMBOL	EQUATION
Integration with respect to time		$y = \int_0^{x_1} dt + i.c.$ $i.c. = y _{t=0}$
Inversion (Change of sign)		$y = -x_1$
Multiplication by a constant		$y = Ax_1$
Summation		$y = x_1 + x_2 + x_3 \dots$

Using the first three of these symbols, we can now construct a block diagram for our differential expression. We start by assuming that a voltage proportional to dN_t/dt exists:

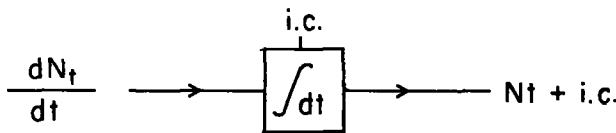

Considering only the rate at which N_t changes, and disregarding its absolute value, we can omit the constant of integration (this constant will be added in the circuit diagram):

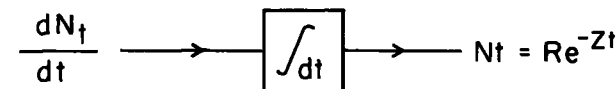

But we know that $\frac{dN_t}{dt} = -RZe^{-Zt}$, so we simply assemble the derivative:

$$\frac{dN_t}{dt} = -RZe^{-Zt} \quad N_t = Re^{-Zt}$$

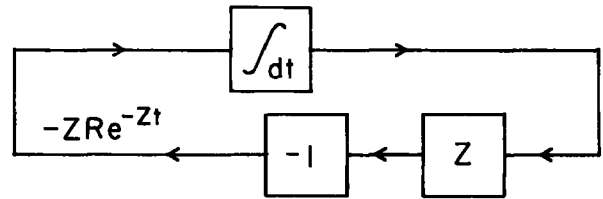

The next step is to construct a circuit diagram showing the actual computing elements and taking account of "initial conditions" and any sign changes that may occur. For this step we use additional symbols:

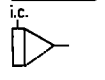
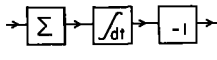
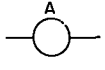
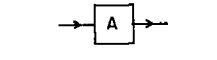
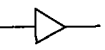
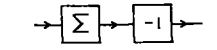
COMPUTING ELEMENT	SYMBOL	BLOCK DIAGRAM EQUIVALENT
Integrating network with Summing Junction		
Potentiometer		
Summing amplifier		

Still disregarding *i. c.*, we have:

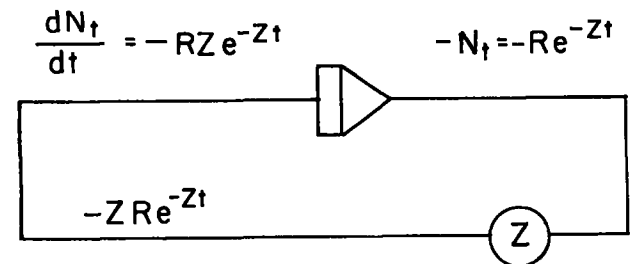

Finally we must supply the "initial condition" voltage, *i. c.*, which is equal to the constant of integration. We noted above, in the definition of the

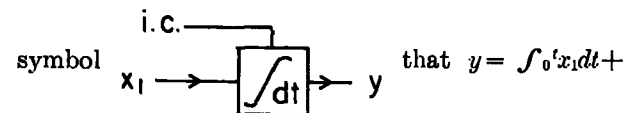

i. c. and $i.c. = y|_{t=0}$. In our equation "y" is replaced by N_t . Since we set $t_r=0$, by definition $N_t|_{t=0} = R = i.c.$ The completed diagram, assuming a computer

reference voltage supply of -10 volts, becomes:

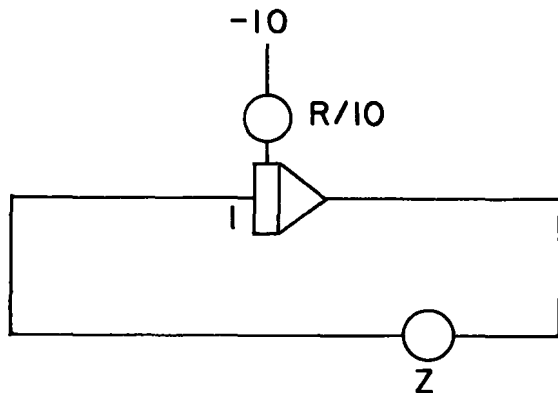

In the operation of the integrating network, *i.c.* only determines the value of N_t (condenser charge) at the beginning of the computation. It is cut off the instant computation begins, and current flow is then confined to the feedback loop. That is why *i.c.* does not appear as a variable in the block diagram. The figure "1" by the integrator input refers to the input resistor. Operation of the integrator is such that the input is multiplied by a factor $100/R_t$ when R_t = input resistance in kilohms.

With the knowledge now at hand we can proceed to set up a circuit in which Z is divided into its components F and M . The equation becomes $N_t = Re^{-(F+M)t}$ and the diagrams are:

BLOCK DIAGRAM

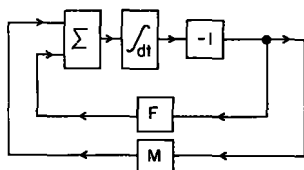

CIRCUIT DIAGRAM

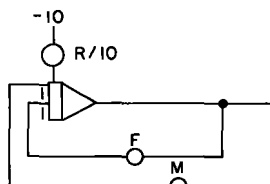

Study of the circuit used here (fig. 2) reveals it to be essentially an elaboration of the basic feedback loop. A multiplier has been added to take care of the nonlinear Gompertz growth curve, and other elements have been added as described in the text. The "time-base" (t) is generated by a simple integrator output. Biologists interested in further information on analog computer programming will find an excellent brief introduction in Strong and Hannauer (1962) or a more extended treatment in Ashley (1963).

The plotter has a pen actuated by two servomotors. One moves it along the "X" axis and the other along the "Y" axis in proportion to an input voltage supplied by the computer. Thus the pen moves to any point X, Y in a system of rectangular coordinates on the plotting surface, corresponding to input voltages V_x and V_y . Since the computer integrates with respect to time, a voltage directly proportional to time is usually fed into "X." The input for "Y" can be taken from any point on the computer circuit to plot the variable(s) desired against time.

As an alternative method of output display, an oscilloscope can be used. This combination requires that the computer be modified for "repetitive operation." Problem solutions are repeated 10 to 100 times per second, so that they appear as curves on the oscilloscope screen. For a permanent record the screen can be photographed as mentioned by Doi (1962).

This oscilloscope display is particularly valuable for curve fitting, since points can be plotted on the face of the tube. In this manner the effect of the potentiometer adjustment in improving the fit is instantly seen.

The work described below was performed on a Pace TR-10 analog computer in conjunction with an EAI Variplotter 1110. The TR-10 is one of the smallest general-purpose analog machines. Since both computer and plotter are fully transistorized, they are small and can be used conveniently atop a desk or small table. The set of units available in the computer as I used it was as follows:

Unit	Number
Amplifier (used with integrator, multiplier, etc.)	10
Coefficient potentiometer (used as above)	18
Null potentiometer (used to set coefficient potentiometers)	1
Integrator (used as above)	4
Multiplier (used as above)	1
Diode function generator (use described later in text)	1
Comparator (use described later in text)	1

GENERATION OF SURVIVAL CURVES

The differential equation needed for generating the survival curve of a given weight of recruits, R_w , is obtained by differentiating expression (4):

$$\frac{dP_t}{dt} = R_w e^{[G - G e^{-\sigma(t-t_r)}] - (F+M)(t-t_r)} [G G e^{-\sigma(t-t_r)} - F - M] \quad (5)$$

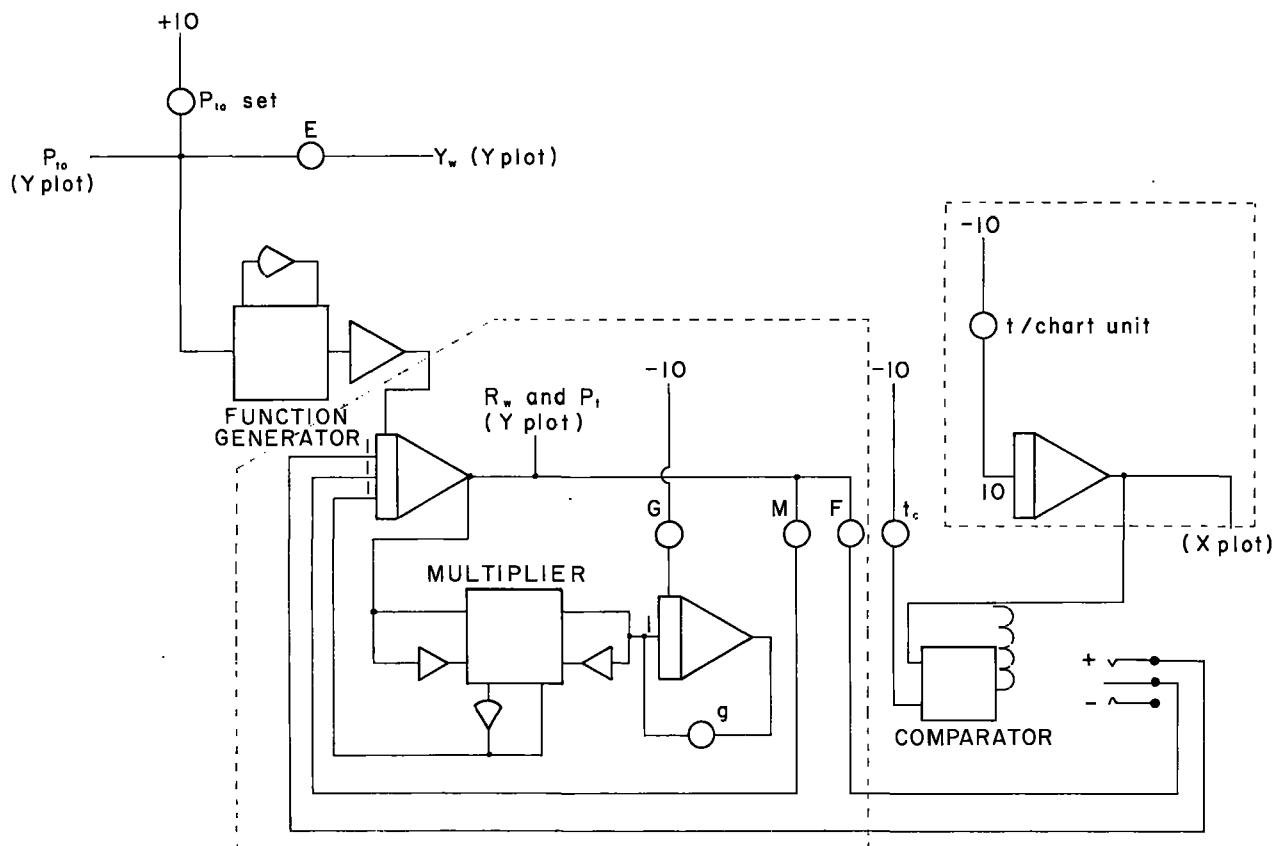

FIGURE 2.—Analog computer circuit for generation of P_t and Y_w . Standard symbols for computing elements, scaling excluded.

By integrating this expression, the computer generates P_t as a function of $(t-t_r)$ for any given values of R_w , g , G , F , and M . The circuit diagram, which includes conventional symbols for the computing elements, is shown within the broken line enclosures of figure 2. The elements outside the broken lines are used in the combination of analog and graphical computation employed to sum the weights of year classes for each season and to determine subsequent recruitment. Their nature and use are described later.

As examples of analog computation, growth and survival curves from the plotter are shown in figures 3 and 4. The data are hypothetical except for the growth constants, which have been derived from data for the California sardine.

Data of growth in weight were obtained by combining a curve of growth in length with a weight-length relation. A table of length-at-age was given in Phillips (1948) and a weight-length relation in Clark (1928). Fitting of the Gompertz relation to

these data (fig. 3) was readily accomplished by successive trials, with appropriate adjustment of the potentiometers for G and g . The fitted curve followed expression (2b), with $w_r=93$ g., $G=0.825$, $g=0.445$, and $t_r=2$ years.

Starting with a hypothetical 1,000 fish, $R_w=93$ kg. when $w_r=93$ g. The upper curve (fig. 4) shows how, with no fishing mortality and low natural mortality, P_t may increase for a year or two before mortality overcomes growth. In the two lower curves the effect of adding a substantial fishing mortality may be seen. Application of an increase in fishing mortality at $t-t_r=2$ resulted in the lower branched curve. This change is readily made on the analog computer by placing the machine in the "hold" mode. The potentiometer for "F" is then reset, the machine returned to "operate" mode and the computation resumed. The ability to change quickly the vital rates during a computation is one of the advantages of the analog machine. It may be done even more conveniently by presetting a number of

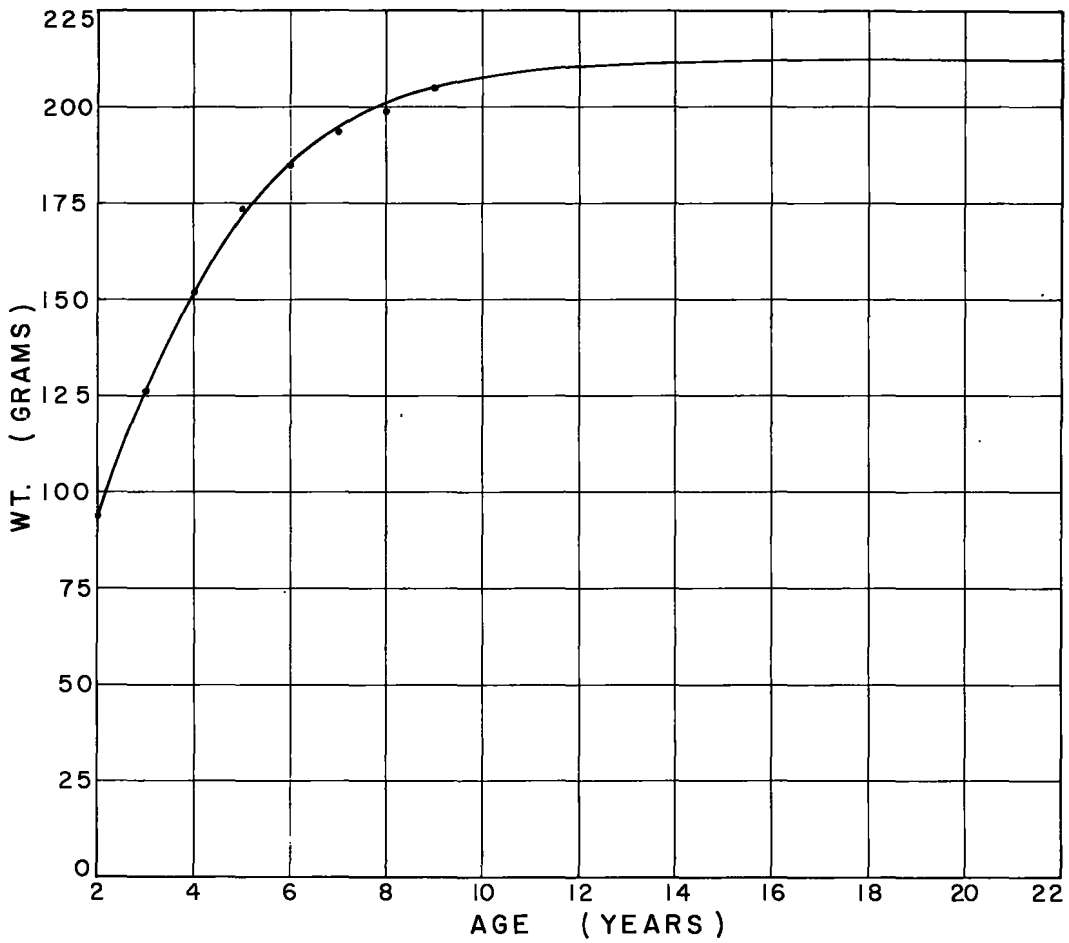

FIGURE 3.—The Gompertz curve fitted to weight-at-age data for the Pacific sardine following expression (2b) in text; $w_r = 93$ g., $G = 0.825$, $g = 0.445$, and $t_r = 2$ years.

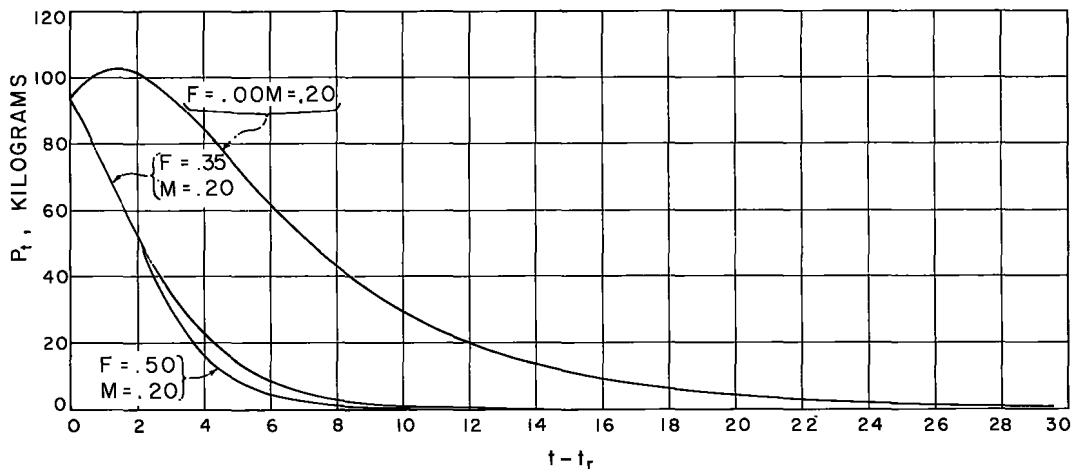

FIGURE 4.—Computer curves of P_t as a function of $(t-t_r)$; growth data from the California sardine, according to expression (4) in text. Values of constants are: $R = 1,000$ fish, $w_r = 93$ g., $R_w = 93$ kg., $G = 0.825$, $g = 0.445$.

potentiometers at needed values of "F" and shifting from one to the other.

PROCEDURE OF SIMULATION

Simulation of populations and yields by a combination analog-graphic approach required development of a standardized procedure. A chart was prepared for the plotter, with appropriately scaled coordinates for time (X-axis) and stock (Y-axis). Vertical lines on this chart marked the points for changes in mortality rates or recruitment relation.

Because the commercial stock in any fishing season is made up of survivors from individual year classes of various ages, that stock cannot be started "full blown," with all year classes present. I therefore started with a stock size such that the rate of exploitation (E) estimated to be in effect would produce a catch (\hat{Y}_w) equal to the real catch for the first fishing-season, or the mean catch for the first two fishing-seasons of the study period. This stock was then built up by starting year classes at times 1, 2, 3, . . . n years before the beginning of the period; n represents the number of years for a year class to pass through the fishery. During this "prestudy" period, the mortality rates in effect at the beginning of the study period were assumed to be in effect. Each i th curve begins at the value of R_{wi} (assumed the same for each year class) required to produce the

specified initial value of total stock $P_{t0} = \sum_{i=1}^{i=n} P_{ti}$.

This value of R_{wi} can be quickly determined by a few computer trials. P_t for each year class is generated until it declines to a small arbitrary value close to zero, but only the portion extending into the study period is plotted.

The initial and subsequent values of P_{t0} are calculated by graphically summing the heights P_{ti} of the i th survival curves for each fishing season, by means of a pair of dividers. Once the initial value of P_{t0} has been obtained, the calculation is self-sustaining. From the recruitment curves, values of R_{wi} corresponding to P_{t0} t_r years before are obtained. R_{wi} is generated as a function of P_{t0} in the Diode Function Generator (fig. 2) by the simple device of setting the P_{t0} potentiometer so that the plotter "Y value" corresponds to the P_{t0} value for the particular year in question. R_{wi} is then plotted by attaching the Y input to the R_w point in the computer circuit. Any empirical or theoretical curve relating recruit-

ment to spawning stock can be set into the Diode Function Generator, which, with an input x_1 , produces an output in the form of a curve $y=f(x_1)$, composed of 10 straight segments.

Survival curves as described above can be generated for each year class entering the fishery during the study period. As in the case of the initial season just described, heights P_{ti} of the individual survival curves for each year are summed graphically, and a mark made representing the total commercial stock,

$P_{t0} = \sum_{i=0}^{i=n} P_{ti}$. The " P_{t0} set" potentiometer is ad-

justed to bring the "Y-value" of the plotter into conformance with the total stock value P_{t0} . The catch is calculated by setting potentiometer "E"

(Fig. 2) at the value $E = \frac{F}{F+M} [1 - e^{-(F+M)}]$. The

catch or yield value proceeds from the simple relation $\hat{Y}_w = EP_{t0}$. It is plotted by attaching the "Y input" of the plotter at the point Y_w in the computer. After plotting of \hat{Y}_w the process for R_{wi} (above) is repeated, and the cycle recommenced.

In outline, then, the process of simulating population and yield is as follows:

1. Set the initial value of \hat{Y}_w at the size of the actual catch for the initial year or two of the study period.

2. Determine initial $P_{t0} = \sum_{i=0}^{i=n} P_{ti}$ from the relation $P_{t0} = \hat{Y}_w / E$.

3. By computer trial, find value R_{wi} such that $\sum_{i=0}^{i=n} P_{ti} = \text{initial } P_{t0}$.

4. Generate n curves of P_{ti} , where n is the number of years required for P_{ti} to decline from R_{wi} to an arbitrary small value near zero. Start at 1, 2, 3, . . . n years before the beginning of the study period.

5. By Diode Function Generator evaluate R_{wi} for each season from P_{t0} for season t_r years before. Generate curves P_{ti} starting at $P_{ti} = R_{wi}$ for each fishing season.

6. For each fishing season, graphically determine $P_{t0} = \sum_{i=1}^{i=n} P_{ti}$. Calculate $\hat{Y}_w = EP_{t0}$.

- Repeat cycle to end of study period, starting each cycle with step No. 5.

EXAMPLE OF APPLICATION

Since hypothetical data are seldom satisfactory to demonstrate the application of a technique, the following example of application to the fishery for Atlantic cod (*Gadus morhua*) is included. It has been used to achieve concreteness, not to make new discoveries about the cod. Catch data were summed for International Commission for the Northwest Atlantic Fisheries Divisions 5Y and 5Z, and the following parameters were assembled for analog computation:

- The central value of $F=0.35$ used in Beverton and Hodder (1962) was assumed to be the average (\bar{F}) for the entire study period 1932-1958. From this figure, values were calculated for eight periods, from the relation $F=qf$, where f was value of fishing effort from Beverton and Hodder and $q=F/f$:

Period	Mean effort thousands of boat-days	$F=qf$, holding mean $Z=0.55$ for:	
		$M=0.2$ (Trials 1 and 2)	$M=0.25$ (Trial 3)
1932-33.....	2.00	0.36	0.31
1934-36.....	1.13	.20	.18
1937-38.....	2.00	.36	.31
1939-41.....	2.77	.50	.43
1942 only.....	1.80	.32	.28
1943-46.....	1.22	.22	.19
1947-48.....	1.80	.32	.28
1949-58.....	2.24	.40	.35

- The central value $M=0.2$ given by Beverton and Hodder was assumed to be in effect during the entire study period.
- Lengths-at-age were obtained from Schroeder (1930) and converted to weights-at-age with a length-weight curve based on data given in Bigelow and Schroeder (1953). A Gompertz curve was fitted to the weights-at-age with constants $G=1.47$, $g=0.340$, and $w_r=5.9$ lb.
- No empirical data were available as the basis of a stock-recruitment curve. After some preliminary experimentation, a hypothetical curve (fig. 5A), with mode at an arbitrary $R_{wt}=32,000$ metric tons, was adopted for the first formal trial. The concavity of the left hand limb was based only on experience from

other species. From data on age composition in Beverton and Hodder it was estimated that $t_r=4$ years.

- From data in Beverton and Hodder (1962) and Silliman and Wise (1961), it was estimated that if $t_c=t_r$ before the change in cod-end mesh size from 27½ to 41½ inches in 1954, then $t_c=t_r+0.25$ year for 1954 and thereafter. This change was accomplished by the comparator (fig. 2), a device which actuates a switch when the input (t in this application) reaches a predetermined value (t_c here). The comparator delayed application of F for one quarter of a year, for year classes entering in 1954-58.

The initial trial simulation, based on the parameters just listed, produced a poor fit of calculated (\hat{Y}_w) to actual (Y_w) catches ($r=-0.17$). On the basis of this trial, the shape of the recruitment curve was altered somewhat (fig. 5B) for the second trial. All other parameters remained the same. After the recruitment relation was revised, a second trial produced a considerably improved fit ($r=0.59$). Finally, the value of M was changed to 0.25 and mean F to

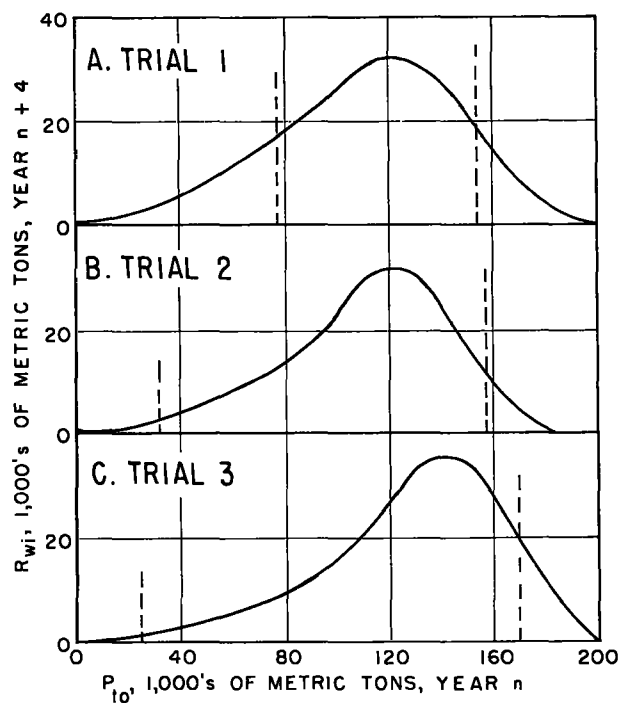

FIGURE 5.—Hypothetical recruitment curves for New England cod. Vertical broken lines indicate range of values used in computations.

0.30, so that $F+M$ remained 0.55. A further adjustment was also made in the recruitment curve (fig. 5C). The third trial, in which these adjustments were employed, yielded a further improvement in the fit ($r=0.69$), which is shown in figure 6. A notable feature of the trials was the sensitivity of the fits to changes in the stock-recruitment relation. The greatest improvement in fit occurred between the first two trials, as the result solely of a moderate change in the shape of the recruit curve (figs. 5A, 5B).

The series \hat{Y}_w and Y_w are not, of course, completely independent, since Y_w enters to some extent into the calculation of the parameters used to compute \hat{Y}_w . As a relative measure of goodness of fit, however, the coefficient is of some value. It is possible to make at least two positive statements regarding r as used here:

1. If the calculated P value is greater than the significance level, the real value is certainly

greater. Additional degrees of freedom will be lost according to the degree of dependence of the variables. It is possible, then, to identify markedly nonsignificant fits.

2. For calculated correlations within conventional significance levels, the value of r serves as a means of comparing two fits. If one set of parameters generates a fit with a higher value of r than another, then it should be closer to the truth than the other.

The parameters used in the simulations have varying and subtle degrees of dependency on the catch data. Thus, to assess accurately the value of P for the coefficients would require a lengthy and complicated statistical analysis. This work appears hardly to be warranted in view of the approximate nature of the simulations.

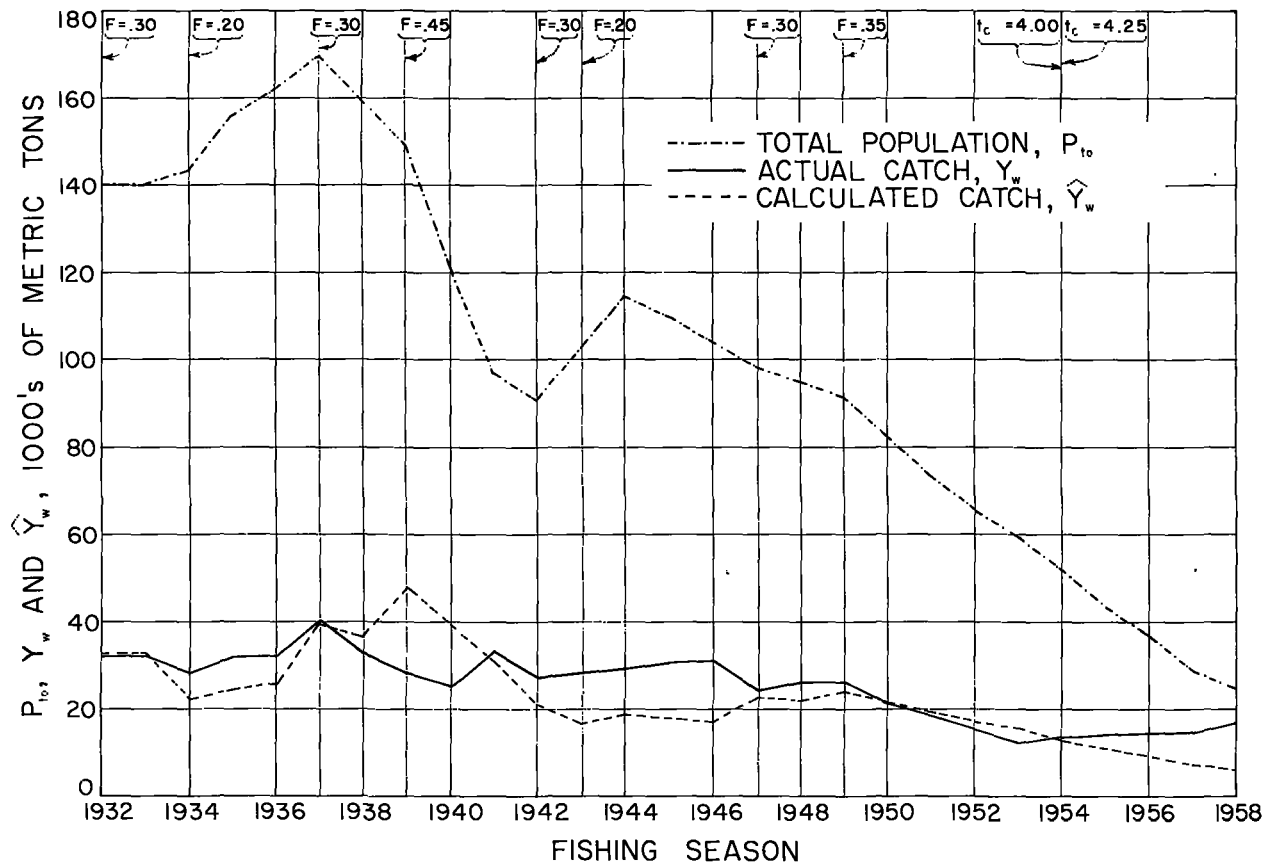

FIGURE 6.—Population and yield simulation for New England cod; $M = 0.25$, $G = 1.47$, and $g = 0.34$ for entire period. Other parameters as shown in drawing.

GENERAL APPLICATION OF THE TECHNIQUE

Application of the analog computer technique described in this report requires estimation of a series of constants or parameters. It also requires a number of approximations and some appraisal of their uniqueness. These two topics will be discussed in this section.

PRELIMINARY ESTIMATES OF PARAMETERS

An extensive literature is available on the estimation of parameters of fish populations under exploitation. The most thoroughgoing summaries and descriptions known to me are given in Beverton and Holt (1957) and Ricker (1958). Treatment here is limited to the specific constants, variables, and relations which must be estimated for simulations by analog computer as described above. They will be considered in descending order of the degree of certainty with which they are likely to be known.

1. Annual yield. For most commercial fisheries this figure is likely to be known rather precisely. Since the original data come from weighouts at the time the fish are first sold, their accuracy has been watched closely by both fishermen and fish buyers. If possible, catches should be segregated according to biological stock units.

2. Growth in weight. Lengths or weights at specific ages are among the most commonly gathered fishery data. If data are in lengths, they must be converted to weights through a length-weight curve. The length-weight relation is fairly stable as compared with other parameters and can be determined from a relatively small number of samples covering the size range of the fish in question. The Gompertz growth curve can be fitted to the empirical data directly on the analog computer simply by adjusting potentiometer settings for G and g until a good fit is obtained.

3. Instantaneous fishing mortality rate, F . This rate may be difficult to estimate with accuracy. If empirical estimates are lacking, however, it may be possible to produce an "educated guess" through general knowledge of the history of the fishery, its changes in yield, the size of the current fishery, This value can be adjusted during simulation.

Once a value of F is available for one period, the values for other periods can be estimated if fishing intensity is known. Data on the number and size of units in the fleet are usually available. These figures must be multiplied by an estimate of time in

operation to obtain the value of fishing effort, f . Once a series of values of f is on hand, together with F and f for a "base period," values of F for all periods can be calculated from the relation $F=qf$, where q is a constant to be determined from the base-period data.

4. Instantaneous natural mortality rate, M . Estimates of M may be available from tagging or biological data, or an assumed value may be selected for the initial trial. If an assumed value must be used, guidance can often be obtained from the growth characteristics of the fish (Beverton and Holt, 1959; Beverton, 1963). For fish in the commercially available stock, values of M are often low, in the vicinity of 0.1 to 0.3. Frequently, reasonable approximations can be obtained by considering M to be constant during the study period, for all ages of fish.

5. Stock-recruitment relation. Of the items required for simulation, this one is usually the most difficult to obtain. If data are available on age composition, it may be possible to estimate the abundance of the youngest (or youngest important) year class in the commercially available stock. A series of such estimates can then be related to the estimated size of the spawning stock t , years earlier, as was done by Clark and Marr (1955). The resulting scatter diagram may reveal a pattern that can form the basis for one or more recruitment curves. It is significant that only the portion of the curve covering the stock sizes encountered can affect the outcome of the simulation.

SUCCESSIVE APPROXIMATIONS AND UNIQUENESS

Once the preliminary estimates of the parameters are assembled, simulation trials can begin. Because all the work is visible on the computer chart as it proceeds, it is often possible to see in what direction the parameters must be changed to produce a better fit of calculated to actual catches. Experimentation is readily accomplished, since all parameters may be changed simply by resetting potentiometers (either coefficient potentiometers or the several small ones in the Diode Function Generator). For trials in the applications above, each trial for 26 or 27 fishing seasons consumed about one-half day. This work included preparation of the chart and all other necessary operations leading to a plot of annual populations and yields. It is thus possible to accomplish several trials within a reasonable period of time.

In any trial-and-error approach involving several variables, the question of uniqueness must be faced. It is fair to ask, if one set of parameters has produced a reasonable result, may not another set produce one that is equally reasonable?

Although it is not possible to answer the above question for the general case, some light may appear from a further examination of the trials on cod reported above. In assessing goodness of fit, I took account of the ratio of mean heights of the calculated and actual catch curves, as well as the correlation between them. Thus I had two criteria of "goodness of fit": \bar{Y}_w/\bar{Y}_w and r . To provide some idea of the discriminative value of these criteria, I made additional simulations in which only F or M was varied and all other parameters were held constant. Curves of calculated values (fig. 7), bracketing those used in the third trial above, are revealing. For this particular set of combinations, only one other than the third approaches its "goodness of fit." The combination of $F=0.35$ with $M=0.25$ produced about as good a fit as the combination of the third trial; r was slightly higher, and \bar{Y}_w/\bar{Y}_w was slightly lower. The difference in F of 0.05, however, is well within what might be considered reasonable error in a rough approximation.

Obviously, curves of the type in figure 7 cannot "prove" the uniqueness of fit obtained with any particular combination of parameters. Since F , M , and the shape and height of the recruitment curve can be continuously varied, the number of possible combinations is infinite. Every effort should be made, therefore, to use reasonable values of biological parameters. Thus we know that F , M , and the recruitment curve are sound because biologists generally recognize that fish stocks are affected by fishing, natural mortality, and recruitment. The question of "reasonable values" is more difficult, but the range of possibilities may be narrowed by use of empirical data as indicated under "Preliminary Estimates of Parameters."

COMPARISON WITH OTHER TECHNIQUES

By appropriate transformations of the formulas, any of the calculations reported above can be performed on either conventional desk calculators or electronic digital computers. It is pertinent, therefore, to consider the relative advantages and disadvantages of analog computation as compared with other techniques.

1. *Initial cost of equipment.*—The analog computer and plotter equipped as I used them cost about \$8,000. This figure is substantially more than a good desk calculator (\$1,000 to \$2,000) but not over one-tenth the cost of comparable digital equip-

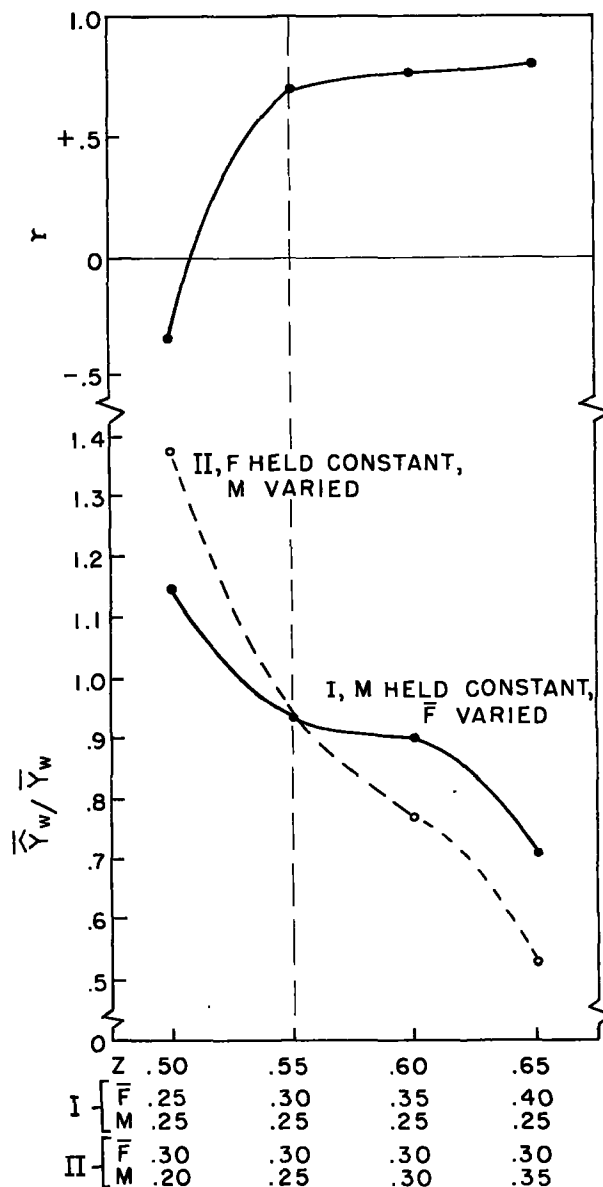

FIGURE 7.—Effect of varying F or M in simulation trials with cod. The value r is the coefficient of correlation between calculated catches (\hat{Y}_w) and actual catches (Y_w). Since r is affected only by Z , and not the ratio of its components F and M , it has only one value for each pair of combinations. The fraction \hat{Y}_w/\bar{Y}_w represents the ratio of the mean calculated catch (\hat{Y}_w) to the mean actual catch (\bar{Y}_w). Vertical line of dashes indicates combination of values used in third cod simulation trial.

ment. It is, of course, possible to perform work on digital machines under contract or rental arrangements at no initial cost. This arrangement is also possible for analog machines.

2. *Time required for computation.*—For the total operation as outlined above, limited tests indicated analog-graphic computation to be about four times as fast as desk calculation. With digital computers, the calculation time is a matter of minutes. If time required for preparation of data for computer calculation, programming the computer, and exchange of data with the computer center are considered, however, total time may well approach that for the analog method.

3. *Visibility of work during computation.*—In the analog-graphic method, stock size, recruitment rate, and yield are all visible in graphic form as the computation proceeds. This advantage is important to the biologist, since it quickly reveals absurd results, or permits him to end a computation that is leading away from reality. Work is invisible during digital computation, and the final "readout" is usually in the form of a table that may have to be plotted for study.

4. *Scale adjustment.*—Quantities generated within an analog computer must be kept within the voltage limits of the machine. This limitation leads to a considerable amount of "fussing" to achieve proper scaling of the variables. This problem is only minor in digital calculation and therefore represents a comparative disadvantage for the analog computer. Fortunately, once scaling has been adopted for a given formula, it can usually be used with only one or two changes when shifting to a new set of empirical data for the same formula.

5. *Accuracy of results.*—Because of the nature of components in an analog computer, the final results are usually accurate only to two or three significant digits. At the present stage of development of fishery science, the empirical data available are not such as to justify carrying more digits. In fact, two-digit accuracy in fishery predictions would be considered more than satisfactory by most fishery administrators. Thus, the accuracy limitations of the analog machine as compared with digital computation do not at present represent a serious disadvantage.

6. *Summary comparison of methods.*—From the above brief listing, the analog technique is seen to have advantages in comparatively low initial cost of equipment, moderately rapid computation rate,

and visibility of results. It has limitations in accuracy and in scaling requirements and is slower than a digital computer. Decision as to which technique to use must depend on the situation of the individual investigator. Factors bearing on the decision include the salaries of persons doing various parts of the work, the accessibility of the research station to a digital computer, and the types of empirical data available.

UTILITY OF THE TECHNIQUE

In this report I have described what may be a useful working tool for the fishery biologist. The example of application given demonstrated the types of basic data needed and the way in which they could be adjusted to improve "goodness of fit" of calculated to actual catches. As with any technique, its utility can be assessed only by those making use of it.

Where extensive biological data are available, simulation is valuable in determining the effects of interaction among the varying mortality, growth, and recruitment rates. The accuracy with which actual catches can be reproduced should serve as a check on the validity of the sampling, analysis, and interpretation involved in the derivation of population parameters.

SUMMARY

1. The objective of this study was to develop an analog-computer simulation technique for modeling exploited fish populations.

2. The mathematical formula for survival of a year class expressed the effect of fishing and natural mortality rates and incorporated a Gompertz curve of growth.

3. Survival curves for successive year classes were generated on an analog computer through use of the differential form of the survival formula. A combined analog-graphic technique summed the weights of survivors in each season to give the weight of the fishable stock.

4. Yield was calculated by applying the rate of exploitation to the fishable stock.

5. Properly lagged recruitment was determined from the stock weight through a stock-recruitment curve.

6. Mechanics of the technique were demonstrated by application to the Atlantic cod.

7. This technique may be applied to any fishery for which good measures or estimates of catch,

growth rate, fishing and natural mortality, and stock-recruitment relation can be obtained.

8. The problem of uniqueness was studied from simulations in which F and M were varied over a range of values. The failure of results to prove uniqueness brings out the importance of using reasonable values of parameters.

9. As compared with other techniques, the analog-graphic approach described here offers low initial cost of equipment, moderate computation speed, ready accessibility of equipment, and good visibility of results during computation. It has limitations in accuracy (two or three digits) and in requirements for scaling variables.

ACKNOWLEDGMENTS

Suggestions from my several reviewers were freely followed in revising the text. Reviews were furnished by Vaughn C. Anthony, Raymond J. H. Beverton, Anthony C. Burd, Paul H. Eschmeyer, Reynold A. Fredin, David J. Garrod, John A. Gulland, Richard C. Hennemuth, Ralph Hile, George Hirschhorn, Peter A. Larkin, Garth I. Murphy, and William E. Ricker. Paul E. Huber, of Electronic Associates, Inc., kindly reviewed the sections on analog computation. John L. McHugh provided guidance during final revision of the manuscript.

LITERATURE CITED

- ASHLEY, J. ROBERT.
1963. Introduction to analog computation. John Wiley and Sons, Inc., New York, 294 pp.
- BARANOV, FEODOR I.
1918. K voprosu o biologicheskii osnovaniyakh rybnogo khozyaystva (On the question of the biological basis of fisheries). Moscow, Izv. Nauch. Issled. Ikhtiol. Inst., Izv. Otd. Rybovod. Nauch.-promysl. Issled. 1(1): 81-128. In Russian.
- BEVERTON, RAYMOND J. H.
1963. Maturation, growth and mortality of clupeid and engraulid stocks in relation to fishing. Cons. Perma. Int. Explor. Mer, Rapp. Proc.-Verb. Réun. 154: 44-67.
- BEVERTON, RAYMOND J. H., and V. M. HODDER.
1962. Report on working group of scientists on fishery assessment in relation to regulation problems. Int. Comm. Northwest Atl. Fish., Annu. Proc. 11 (suppl.): 1-81.
- BEVERTON, RAYMOND J. H., and S. J. HOLT.
1957. On the dynamics of exploited fish populations. Great Brit. Min. Agr. Fish. Food, Fish. Invest. ser. 2, 19: 1-533.
1959. A review of the lifespans and mortality rates of fish in nature, and their relation to growth and other physiological characteristics. Ciba Found. Colloquia on Ageing, 5: 142-180. Little, Brown and Co., Boston.
- BIGELOW, HENRY B., and WILLIAM C. SCHROEDER.
1953. Fishes of the Gulf of Maine. U.S. Fish Wildl. Serv., Fish. Bull. 53: viii + pp. 1-577.
- CLARK, FRANCES N.
1928. The weight-length relationship of the California sardine (*Sardina caerulea*) at San Pedro. Calif. Div. Fish Game, Fish Bull. 12, 59 pp.
- CLARK, FRANCES N., and JOHN C. MARR.
1955. Population dynamics of the Pacific sardine. In Progress Report, 1 July 1953 to 31 March 1955: 11-48. Calif. Dep. Fish Game, Mar. Res. Comm., Calif. Coop. Oceanic Fish. Invest.
- DOI, TAKEYUKI.
1957. An analogue computer for analyzing the properties of marine resources and predicting catches. Joint Sci. Meet., Int. Comm. Northwest Atl. Fish., Int. Counc. Explor. Sea, Food Agr. Organ. UN, Lisbon, Doc. P. 12, 14 pp.
1962. The predator-prey and competitive relationships among fishes caught in waters adjacent to Japan. Bull. Tokai Regional Fish. Lab. 32: 49-118 (Fish. Res. Bd. Can., Transl. Ser. 461).
- GARFINKEL, DAVID, and RICHARD SACK.
1964. Digital computer simulation of an ecological system, based on a modified mass law. Ecology 45 (3): 502-507.
- GRAHAM, MICHAEL.
1935. Modern theory of exploiting a fishery, and applications to the North Sea trawling. J. Cons. 10 (3): 264-274.
- HOLT, S. J., J. A. GULLAND, C. TAYLOR, and S. KURITA.
1959. A standard terminology and notation for fishery dynamics. J. Cons. 24(2): 239-242.
- INTERNATIONAL NORTH PACIFIC FISHERIES COMMISSION.
1962. The exploitation, scientific investigation and management of salmon (genus *Oncorhynchus*) stocks on the Pacific Coast of the United States in relation to the abstention provisions of the North Pacific Fisheries Convention. 6. Supplementary information on salmon stocks of the United States: Return escapement relationships: salmon. Int. N. Pac. Fish. Comm., Bull. 10: 67-72.
- LARKIN, P. A., and A. S. HOURSTON.
1964. A model for simulation of the population biology of Pacific salmon. J. Fish. Res. Bd. Can. 21(5): 1245-1265.
- LARKIN, P. A., and W. E. RICKER.
1964. Further information on sustained yields from fluctuating environments. J. Fish. Res. Bd. Can. 21(1): 1-7.
- MARGALEF, RAMON
1962. Simplified physical models of populations of organisms. Mem. Real Acad. Cien. Art., Barc. 34(5): 1-66.
- ODUM, HOWARD T.
1960. Biological potential and analogue circuits for the ecosystem. Amer. Sci. 48(1): 1-8.

- PAULIK, GERALD J., and L. E. GALES.
1964. Allometric growth and the Beverton and Holt yield equation. *Trans. Amer. Fish. Soc.* 93(4): 369-381.
- PHILLIPS, JULIUS B.
1948. Growth of the sardine, *Sardinops caerulea*, 1941-42 through 1946-47. *Calif. Div. Fish Game, Fish Bull.* 71: 1-32.
- PLATT, JOHN R.
1964. Strong inference. *Science* 146(3642): 347-353.
- RICKER, WILLIAM E.
1958. Handbook of computations for biological statistics of fish populations. *Fish. Res. Bd. Can., Bull.* 119, 300 pp.
- RUSSELL, EDWARD S.
1931. Some theoretical considerations on the "over fishing" problem. *J. Cons.* 6(1): 3-20.
- SCHAEFER, MILNER B.
1954. Some aspects of the dynamics of populations important to the management of the commercial marine fisheries. *Inter-Amer. Trop. Tuna Comm., Bull.* 1(2): 27-56.
- SCHAEFER, MILNER B., and R. J. H. BEVERTON.
1963. Fishery dynamics—their analysis and interpretation. *In The sea* 2 (ch. 21): 464-483. Interscience Publishers (John Wiley and Sons), New York.
- SCHROEDER, WILLIAM C.
1930. Migrations and other phases in the life history of the cod off southern New England. *U.S. Bur. Fish., Bull.* 46: 1-136.
- SILLIMAN, RALPH P. and J. P. WISE
1961. Effects of increased trawl cod-end mesh size on Georges Bank haddock yields. *Int. Comm. Northwest Atl. Fish., Annu. Meet., June 1961, Doc. 11, Ser.* 829, pp. 1-14.
- STRONG, JOHN D., and GEORGE HANNAUER.
1962. A practical approach to analog computers. *Instruments and control systems* 35 (8), 10 pp. [Reprints available at no cost from Electronic Associates, Inc., Long Branch, N.J. 07740.]
- THOMPSON, WILLIAM F., and F. H. BELL.
1934. Biological statistics of the Pacific halibut fishery. (2) Effect of changes in intensity upon total yield and yield per unit of gear. *Rep. Int. Fish. Comm.* 8: 1-49.
- WEYMOUTH, F. W., and H. C. McMILLIN.
1931. The relative growth and mortality of the Pacific razor clam (*Siliqua patula*, Dixon), and their bearing on the commercial fishery. *U.S. Bur. Fish., Bull.* 46: 543-567.
- WILLMOVSKY, NORMAN J., and ERIC C. WICKLUND.
1963. Tables of the incomplete beta function for the calculation of fish population and yield. *Inst. Fish., Univ. Brit. Columbia, Vancouver, Can.*, 291 pp.
- WINSOR, CHARLES P.
1932. The Gompertz curve as a growth curve. *Proc. Nat. Acad. Sci.* 18(1): 1-8.