

**MORTALITY OF SALMON FINGERLINGS
EXPOSED TO PULSATING
DIRECT CURRENT**

**BY GERALD B. COLLINS, CHARLES D. VOLZ
AND PARKER S. TREFETHEN**

FISHERY BULLETIN 92

**UNITED STATES DEPARTMENT OF THE INTERIOR, Douglas McKay, *Secretary*
FISH AND WILDLIFE SERVICE, John L. Farley, *Director***

ABSTRACT

Influences of voltage gradient, current density, pulse frequency, and duration of exposure on the mortality of salmon fingerlings exposed to pulsating direct current were examined experimentally in relation to the length of fish, water temperature, and pulse duration, using a current of square-wave form.

The experiments indicated that mortality increased with an increase in voltage gradient, in current density, or in both. The effect of voltage gradient increased with the duration of exposure. The total voltage to which the fish were subjected (fish length \times voltage gradient) was the effective factor in mortality, rather than the voltage gradient, and the effect of total voltage on mortality was actually greater on shorter fish when the exposure was only 30 seconds. Pulse duration was not a lethal factor, and there was no direct relation between mortality and the total energy applied per unit of time. Under the conditions of these experiments, mortality increased with the pulse frequency, and the effect of pulse frequency on mortality increased with the length of the fish and the duration of exposure.

The mortality of the fingerlings exposed to pulsating d. c. increased with the duration of exposure, and the effect of duration of exposure increased with the length of the fingerlings. Mortality increased with the water temperature, and the effect of water temperature on mortality increased with the duration of exposure. The effect of water temperature on mortality was greater on fish of greater length.

UNITED STATES DEPARTMENT OF THE INTERIOR, Douglas McKay, *Secretary*

FISH AND WILDLIFE SERVICE, John L. Farley, *Director*

MORTALITY OF SALMON FINGERLINGS EXPOSED TO PULSATING DIRECT CURRENT

By GERALD B. COLLINS, CHARLES D. VOLZ, and PARKER S. TREFETHEN



FISHERY BULLETIN 92

From Fishery Bulletin of the Fish and Wildlife Service

VOLUME 56

UNITED STATES GOVERNMENT PRINTING OFFICE • WASHINGTON: 1954

For sale by the Superintendent of Documents, U. S. Government Printing Office, Washington 25, D. C.

Price 30 cents

CONTENTS

	Page
Historical background.....	61
Materials and methods:	
Method.....	62
Apparatus.....	62
Measurements.....	63
Procedure.....	63
Controls.....	64
Experimental limitations.....	64
Graphs and computations.....	66
Experiments:	
Voltage gradient and current density.....	66
Pulse frequency.....	70
Pulse duration.....	72
Fish length and duration of exposure.....	78
Temperature.....	78
Discussion.....	78
Summary.....	80
Literature cited.....	81

MORTALITY OF SALMON FINGERLINGS EXPOSED TO PULSATING DIRECT CURRENT

By GERALD B. COLLINS, CHARLES D. VOLZ, and PARKER S. TREFETHEN, *Fishery Research Biologists*

HISTORICAL BACKGROUND

Protection of salmon fingerlings on their downstream migrations is one of the major problems to be solved if the salmon fishery of the Pacific Northwest is to be maintained at its present level. Water resources are being developed for power, irrigation, navigation, and flood control at a rapidly accelerating pace, and the cumulative effect of many dams and water diversions seriously threatens this important natural food resource.

Mechanical screening is used at some of the smaller installations to prevent fingerlings from being swept into turbine intakes or into water diversions, but it is expensive to install and difficult to maintain. At larger dams, where huge volumes of water are involved, mechanical screens are generally considered impractical.

Electric screens have been in use for more than 30 years, with most applications endeavoring to establish an electrical field as a barrier or "fence" to prevent entrance of fish into a given area. These have generally been unsatisfactory with migrating fish, and particularly so with downstream-migrating salmon. The fingerlings seem unable to avoid the electrical field and are stunned or even killed rather than diverted.

Attention has been turned to the use of the directional properties of electric fields as a means of diverting the downstream migrants from hazardous areas. For many years it has been known that under certain conditions when fish are subjected to direct current (d. c.), the fish tend to move toward the positive electrode. Advances in the field of electronics now make it seem likely that this behavior can be put to practical use in controlling the movements of salmon fingerlings. Toward this end the United States Fish and Wildlife Service has initiated a program of research on electrical fish guiding which includes basic laboratory studies as well as large-scale field experiments. The material

presented here is a report on one aspect of the research in progress.

A prerequisite to field experiments on electrical fish guiding is a knowledge of the electrical conditions that are injurious or lethal to fish. The range of electrical conditions to which fish can be subjected safely should be defined in advance to avoid the possibility of destroying large numbers of migrating fish during field tests.

Although the effect of electric current upon fish has been a subject of interest and research for at least 50 years, relatively little attention has been paid to its effect upon the mortality of fishes. Scheminzky (1924) outlined the reactions of fish subjected to electric current that occur at successively higher energy levels as follows: (1) The threshold of sensory recognition, (2) electrotaxis, (3) electronarcosis, and (4) at the highest energy level, death. Most of the research has been concerned with the responses at the three lower levels, and observations on mortality have been largely incidental.

Experimenting with electric fish screens, McMillan (1928) described tests using alternating current (a. c.), in which the mortality of salmon fingerlings increased with increases in voltage gradient and current density. He also pointed out the direct relation of mortality to the duration of exposure. Groody, Loukashkin, and Grant (1950), investigating electrotaxis of sardines, reported a relation between current density and mortality that depended upon the size of the fish and the duration of exposure, which relation they found to be "especially true when nonpulsating current was used." Similar observations by research workers studying the effects of electric fish screens and electric fish shockers were usually based on reactions to continuous d. c. or to a. c. In general, the observations on mortality which were made during investigations of recognition thresholds, electrotaxis, or electronarcosis, were inadequate for the purposes of the present study on electrical guiding of salmon

fingerlings. A more detailed understanding of the factors affecting the mortality of salmon fingerlings exposed to pulsating or interrupted d. c. was needed. In the laboratory experiments described in the following pages, the mortality of salmon fingerlings subjected to pulsating d. c. was measured in relation to factors such as the voltage gradient, current density, pulse frequency (pulse repetition rate), pulse duration (pulse width), water temperature, size of fish, and duration of exposure.

Charles Ellis, supervisor of hatcheries, State of Washington, and Lewis Garlick, regional supervisor, Branch of Game Fish and Hatcheries, Fish and Wildlife Service, made available the supply of salmon fingerlings used in this study. The cooperation of personnel at the Green River, Issaquah, and Samish hatcheries of the State of Washington and the Leavenworth hatchery of the Fish and Wildlife Service is gratefully acknowledged. Fishery aids Robert H. Lander and Gene D. Chard of the Fish and Wildlife Service carried out many of the tests and assisted in compiling the data and in preparing the material for publication. Professor Lorne Kersey, University of British Columbia, Professor George Hoard and Leon Verhoeven, University of Washington, and Harlan Holmes and Elizabeth Vaughan, Fish and Wildlife Service, critically reviewed the manuscript and offered many helpful suggestions.

MATERIALS AND METHODS

The experiments were conducted from May to August 1952, at the laboratory of the United States Fish and Wildlife Service in Seattle, Wash. Chinook fingerlings (*O. tshawytscha*) which were used in all tests (the one exception is noted) were transported in milk cans from the Washington State hatcheries at Green River, Issaquah, and Samish, and from the Federal hatchery at Leavenworth, Wash., and were placed in circular, wooden holding tanks 4 feet in diameter and 3 feet in depth. The maximum holding period at the laboratory before the fingerlings were used in the experiments was 4 days.

METHOD

A direct experimental approach was used in which two or three of the factors whose influence was to be examined were each varied while other factors were maintained relatively constant. The

influence of voltage gradient, current density, pulse frequency, and duration of exposure upon the mortality of salmon fingerlings exposed to pulsating d. c. was examined directly in relation to the length of the fish, water temperature, and pulse duration. Fingerlings were held in uniform alinement with reference to the direction of the electrical field and were subjected for a specified time to a pulsating d. c. field with defined characteristics. The fingerlings were then held 1 hour after exposure, and the number of mortalities was recorded.

Mortality was interpreted to include any fish that had not completely recovered equilibrium within 1 hour after exposure to the electrical field. This arbitrary definition was based on exploratory tests in which 96 percent of the fish that had not recovered equilibrium within 1 hour after exposure died within the next 6 hours.

APPARATUS

The experiments were performed in a rectangular plastic tank (fig. 1) in which two flat, stainless-steel, screen electrodes were suspended perpendicular to the long axis. The electrodes exactly fit the inside dimensions of the tank to ensure a uniform electrical field. Vertical stalls, 2 cm. deep, 1.5 cm. wide, and 12 cm. long, made of thin plastic were placed between the electrodes, parallel to the long axis of the tank, to keep the fish in alinement parallel to the field. In the tests in which fish were alined across the field, stalls made of plastic screening were used. Plastic screening at the end of the stalls and a plastic cover on the top prevented the fingerlings from jumping out when electric current was applied. The sides of the tank were marked in centimeter units for convenience in establishing the distance between the electrodes.

Throughout the experiments, a current of square-wave form was used (fig. 2). The pulsating, or interrupted, d. c. was supplied by a specially constructed square-wave generator (fig. 3) which was made up of seven units. Unit 1, the pulse-rate frequency generator, used a gas triode (6D4) as a relaxation oscillator, producing a saw-tooth wave of variable frequency (2 to 15 pulses a second.) The flyback of the saw-tooth was differentiated by an RC network, and the negative pulses produced were amplified and inverted by a pentode (6AC7) pulse amplifier, unit 2. The

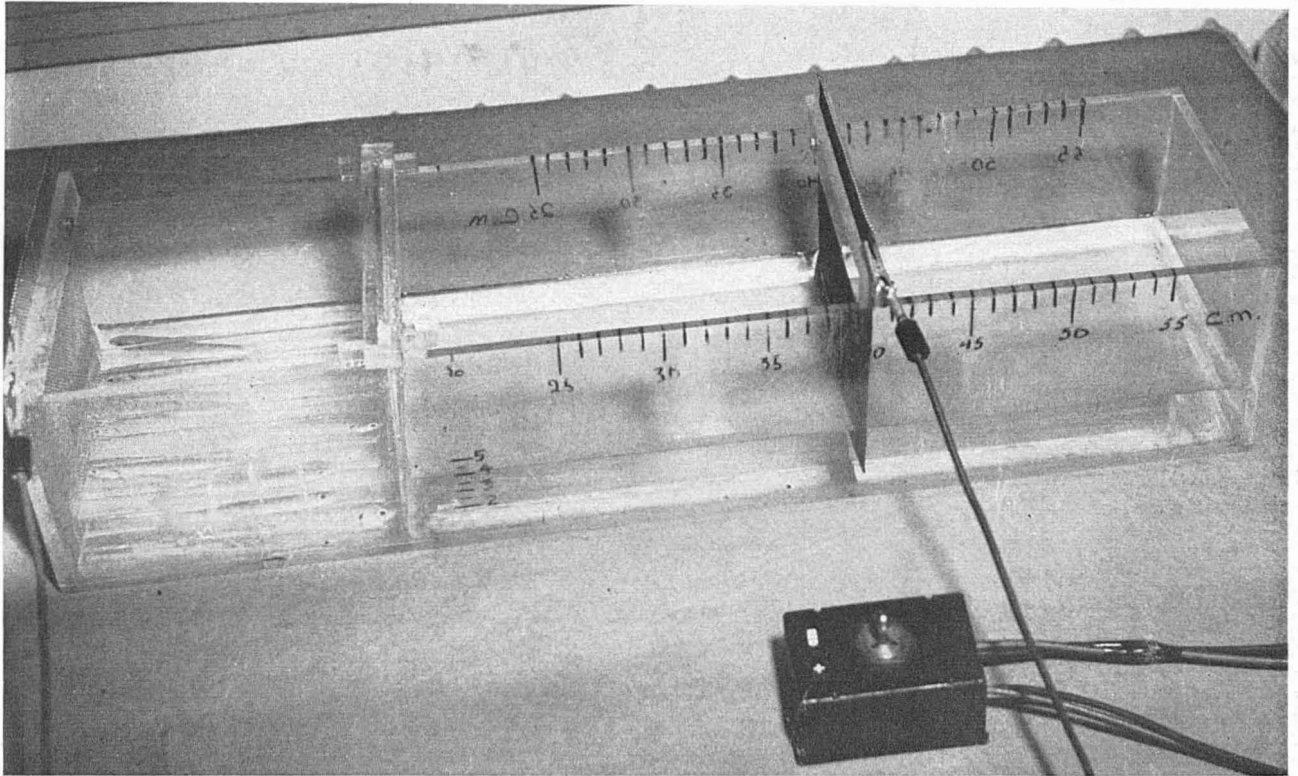

FIGURE 1.—Experimental tank, 60 cm. x 15 cm. x 11 cm.

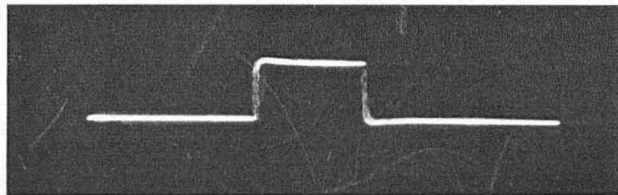

FIGURE 2.—Photograph of wave form on oscilloscope.

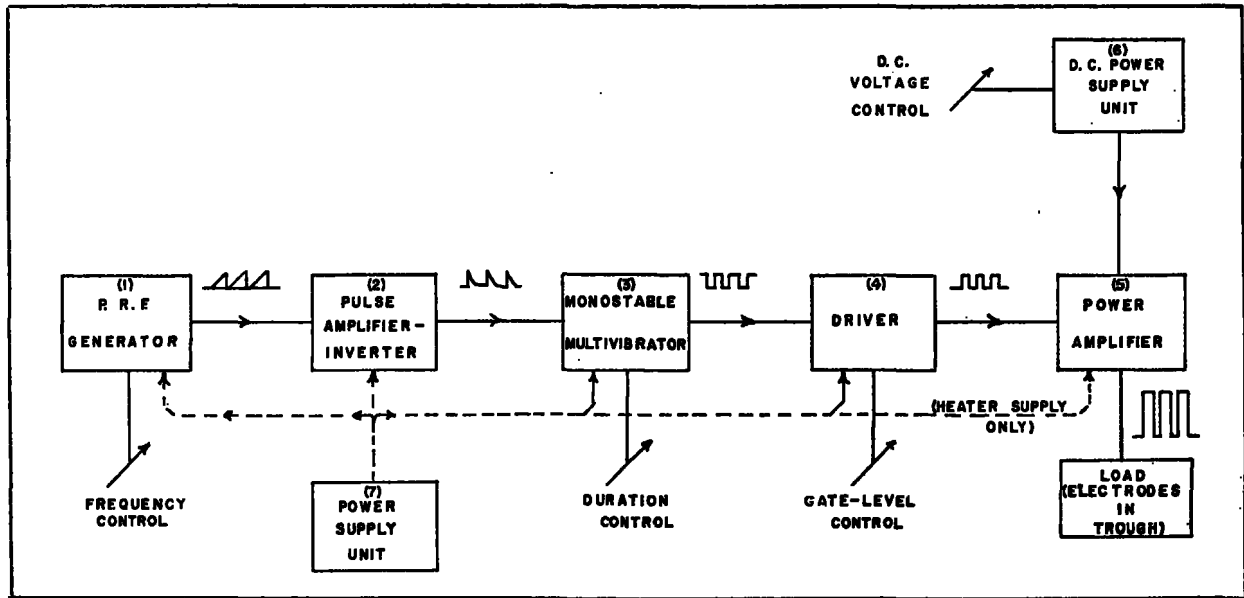

FIGURE 3.—Block diagram of square-wave generator.

positive pulses from unit 2 triggered unit 3, two dual triodes (6SN7) as a monostable multivibrator with a variable period of 5 to 300 milliseconds, which controlled the duration of the pulse. The negative square wave from unit 3 controlled the power pentode (6L6) driver stage, which inverted the pulse to produce a positive square wave to drive the power amplifier (unit 5), two dual triodes (6AS7G). The gate-level control on stage 4 controlled the cutoff bias of the power-amplifier stage and was used as a zero-set and fine-voltage control for the output. The plate supply for the power amplifier contained two mercury-vapor rectifiers (872-A). The primary voltage of the plate transformer was controlled to provide output-voltage control, variable from 0 to 600 volts, at a maximum drain of 1.25 amperes. The square-wave output of unit 5 was taken across a resistor in the cathode returns of the 6AS7G tubes. Plate, bias, and heater voltages were supplied by a separate power unit (7), which had power-rectifier (5V4G), bias-rectifier (6X4), and voltage-regulator tubes (2-OD3, 1-OB3, and 1-OA2), plus the necessary transformers, chokes, capacitors, and resistors.

MEASUREMENTS

All measurements of electrical characteristics were accurate to within 10 percent and most to within 5 percent.

Voltage was measured with a calibrated cathode-ray oscilloscope. Voltage gradient was calculated from the distance between electrodes and the total voltage across the electrodes, since measurements made with the plastic stalls and screens in place showed the field to be uniform within the limits of the measuring equipment.

The specific resistance of the water was measured by a conductivity bridge. Current density was computed from the resistance of the water and the voltage gradient. Current-density computations were checked against measurements made by reading voltage across a precision resistor (1 percent).

Pulse frequency was calibrated by a low-frequency oscillator and checked frequently by means of a stop watch at low rates, and by visual oscilloscope comparison with 60-cycle sine waves at rates of from 5 to 16 pulses a second. Frequency stability was within 1 percent.

Pulse duration was calibrated against a low-frequency oscillator by use of a direct-coupled electronic switch. The accuracy and stability was 1.0 millisecond.

Fish lengths are total lengths from tips of snouts to extreme ends of tails.

PROCEDURE

Fingerlings, in groups of 10, were placed in the stalls in the area between the electrodes in the

plastic tank. No attempt was made to head the fish toward either electrode after exploratory experiments failed to reveal any significant difference in mortality between fingerlings headed toward the positive electrode and fingerlings facing away from it. A cover was placed over the top to prevent the fish from jumping out, then the electric current was turned on, and the duration of exposure was timed by a stop watch. Immediately after exposure the fingerlings were placed in aerated glass bowls where they were held for 1 hour. At the end of that time the dead fish and those that had not completely recovered equilibrium were removed, and their number and lengths recorded. The number and lengths of the remaining fish were also recorded.

During most of the tests, to minimize the need for adjustment to new water conditions, the water used in the experimental tank and in the aerated bowls for holding the fish after exposure was taken from the large holding tank when the fish were brought into the laboratory. The temperature and resistance of the water were usually measured every fourth exposure; however, during tests examining the effect of current density, the resistance of the water was measured before each exposure and the water was adjusted to the desired resistance by the addition of distilled water or an NaCl solution.

During tests examining the influence of water temperature, fingerlings were placed in large aerated containers, and temperatures were gradually raised or lowered at a rate of change less than 2° C. per hour until the desired temperature was reached. The fish were exposed to the electrical field at the desired temperature and were held for 1 hour after exposure at the same temperature.

Throughout these experiments fingerlings were exposed to an electrical field only once (a fish surviving one test was never used in another) to avoid any possible effect due to conditioning.

CONTROLS

To ensure that mortality was not the result of handling, confinement, temperature change, et cetera, with each new supply of fishes, a control group was subjected to the same treatment as the experimental fish with the exception that power was not turned on. Among 2,800 fingerlings used as controls the mortality was only 0.5 percent.

EXPERIMENTAL LIMITATIONS

Lack of control over water temperatures in holding tanks and water sources for experiments (except in the circumstances described in Procedure) resulted in experiments being carried out under a rather wide range of temperatures. The experiments began in May and continued until August with water temperatures increasing from 10° to 19° C.

The procedure followed in the experiments tended to minimize the effect of variation of temperature upon the slope of the curves shown. Fingerlings in groups of 10 were subjected to a complete range of the variables being examined each time the tests were run. The entire experiment was then repeated several times at a later date until the numbers of fish were sufficiently large. Thus one part of the curve was not determined at one temperature and another part at a different temperature. The curves represent the effect at the median temperature of the range shown.

The experiments began with fingerlings in the smaller size ranges, and as the season progressed the sizes increased. Usually only a limited range of length was available at one time. The fish were taken from four different hatcheries throughout a period of 4 months. They were transported and held under a variety of conditions, and undoubtedly some groups were in better physical condition than others. An attempt was made to expose the fish from each group to the entire range of all the variables being examined. For the experiments in which large numbers of fish were used, the data include the reactions of several groups of fish, and the curve represents the effect on fish of the average physical condition.

Fluctuations in water temperature and the physical condition of the fish are probably responsible for some of the scatter shown in the data. However, the validity of relations shown by the compiled data was verified by examining the same relations in single tests with one group of fish under a single set of conditions. Examples of this method of verification are shown by the circled data in figure 12 and the insert in figure 14.

Another factor that must be considered is the distortion of the lines of current flow due to the difference between the resistance of the fish and resistance of the water. The voltage gradients and current densities shown in the graphs are

those existing in the water before the fish were placed in it and are not the voltage gradients and current densities created within the fish. Measurements made during those experiments in

which there would be a maximum distortion of the field (minimum electrode spacing, large fish, and water of high resistance) indicated that the maximum error due to distortion of the field

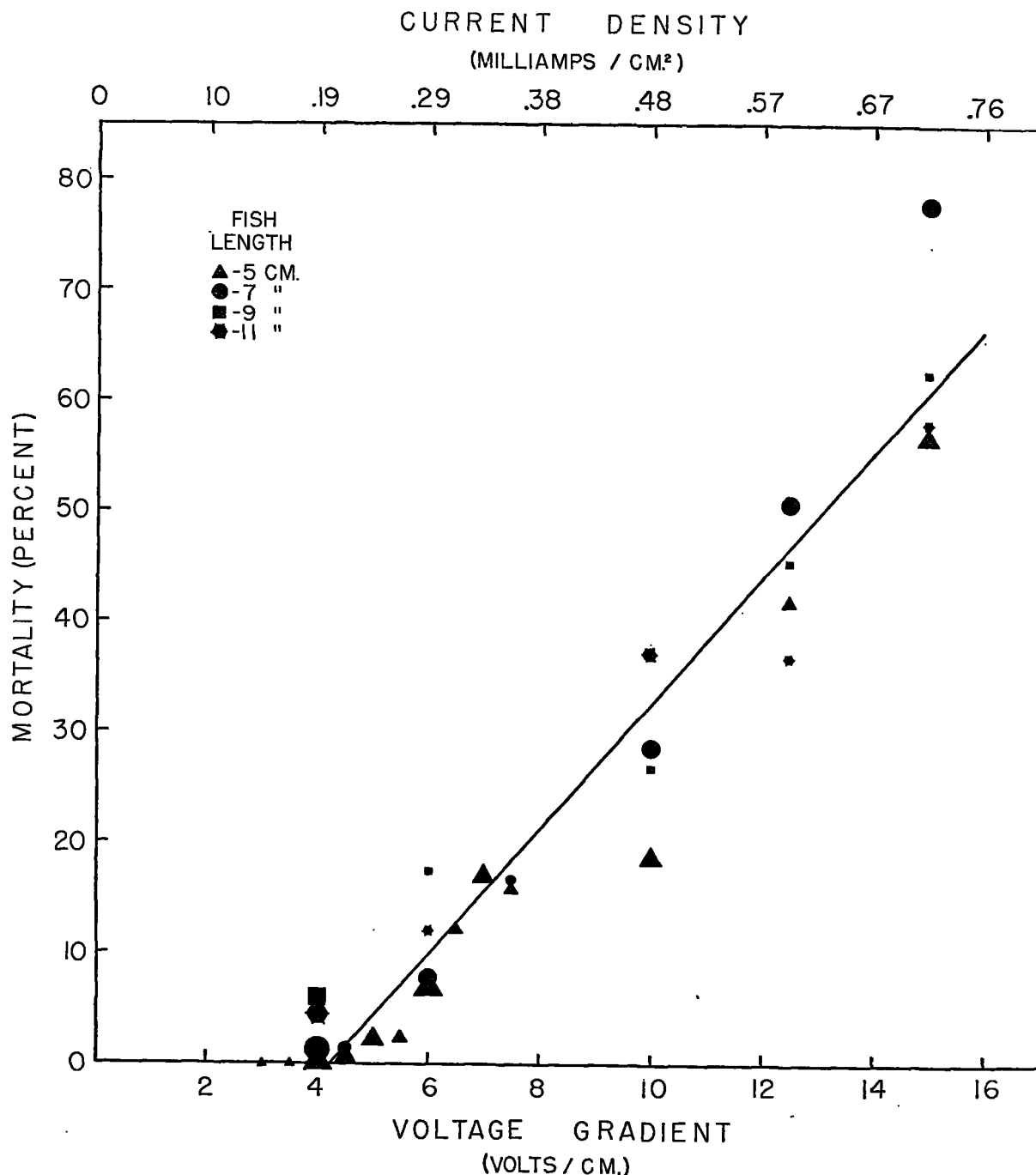

FIGURE 4.—Combined effects of voltage gradient and current density in relation to fish length upon mortality of salmon fingerlings (*Oncorhynchus tshawytscha*) exposed to pulsating d. c. Tests run at 2 pulses/sec., pulse duration 20 milli-secs., temperature range 10.0° to 19.9° C., duration of exposure 30 seconds. Sizes of symbols correspond to fish number categories: 10-49, 50-99, 100-199, and 200-227.

was less than 10 percent. For example, measurements of the total current across the electrodes made with no fish in the apparatus, with one fish in each stall, and with two fish in each stall, with electrode spacings varying from 20 cm. to 50 cm. at a gradient of 1 volt/cm., and a water resistance of 16,000 ohms/cm.³, were all in agreement within 10 percent. It is probable that some of the scatter in the data may be due to the distortion of the electrical field, or perhaps to electrolysis; however, it is unlikely that the errors are great enough to seriously affect the relations shown.

GRAPHS AND COMPUTATIONS

The curves shown in figures 4 to 14 were calculated by the method of least squares weighted to the number of fish at each point and include all data with mortality values greater than zero and less than 80 percent. Some of the relations shown would probably be best described by sigmoid curves if the data were more complete, but for simplification straight lines of regression have been used to describe them.

The fish lengths indicated in the graphs are the midvalues of 2 cm. groupings (e. g., 5 cm. includes lengths from 4 cm. to 5.9 cm.).

EXPERIMENTS

VOLTAGE GRADIENT AND CURRENT DENSITY

To examine the combined effects of voltage gradient and current density in relation to fish length upon the mortality of salmon fingerlings exposed to pulsating d. c., a series of experiments

was run in which chinook fingerlings of different sizes were subjected to a pulsating field at various levels of voltage gradient and current density. During each of these experiments, water temperature, water resistance, pulse frequency, pulse duration, and duration of exposure were maintained constant. The results of the tests are summarized in figure 4, and the numerical data are given in table 1.

The data indicate that above a certain threshold, mortality increases in proportion to each increase in voltage gradient and current density. There is no indication of a relation between the length of the fingerlings and the combined effect of voltage gradient and current density upon mortality.

The situation in the experiments described above was comparable to what would exist in field applications of d. c. for guiding fish, in that the resistance of the water remained constant while the current density changed as the voltage gradient was varied. To complete the study, it was decided to examine independently the effect of current density upon mortality of fingerlings exposed to pulsating d. c. A series of experiments was run in which fingerlings of different lengths were exposed at various levels of current density while the voltage gradient was held constant. This was achieved by modifying the resistance of the water with NaCl solution. Water temperatures, pulse frequency, pulse duration, and duration of exposure were also held constant during each of these experiments. The tests are summarized in figure 5 and the numerical data are shown in table 2.

TABLE 1.—Combined effects of voltage gradient and current density in relation to fish length on mortality of salmon fingerlings

	Fish length of—											
	4 to 5.9 cm.			6 to 7.9 cm.			8 to 9.9 cm.			10 to 11.9 cm.		
	Number exposed	Number dead	Mortality (percent)	Number exposed	Number dead	Mortality (percent)	Number exposed	Number dead	Mortality (percent)	Number exposed	Number dead	Mortality (percent)
3 volts/cm.....	24	0	0									
3.5 volts/cm.....	12	0	0									
4 volts/cm.....	227	1	.4	241	3	1.2	102	6	5.9	125	6	4.8
4.5 volts/cm.....	137	1	.7	69	1	1.4						
5 volts/cm.....	123	3	2.4									
5.5 volts/cm.....	79	2	2.5									
6 volts/cm.....	200	14	7.0	130	10	7.7	23	4	17.4	25	3	12.0
6.5 volts/cm.....	89	11	12.4									
7 volts/cm.....	100	17	17.0									
7.5 volts/cm.....	88	14	15.9	12	2	16.7						
10 volts/cm.....	167	31	18.6	154	44	28.6	30	8	26.7	86	32	37.2
12.5 volts/cm.....	91	38	41.8	148	75	50.7	22	10	45.4	19	7	36.8
15 volts/cm.....	104	59	56.8	135	105	77.8	24	15	62.5	14	8	57.0

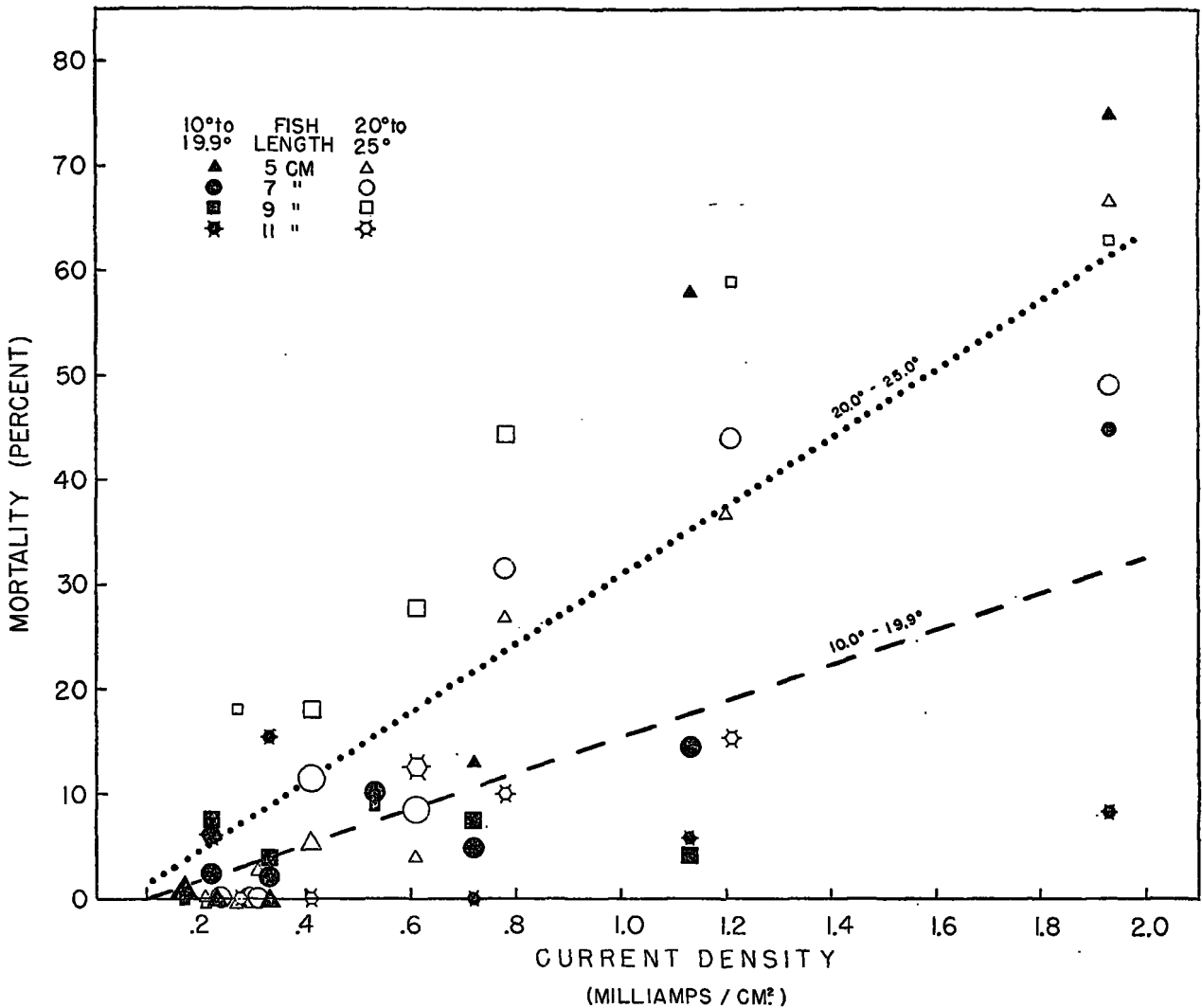

FIGURE 5.—Effect of current density in relation to fish length and water temperature upon mortality of salmon fingerlings (*Oncorhynchus tshawytscha*) exposed to pulsating d. c. Tests run at 4 volts/cm., 2 pulses/sec., pulse duration 20 milli-sec., duration of exposure 30 seconds. Sizes of symbols correspond to fish number categories: 23-74, 75-149, and 150-443.

TABLE 2.—Effect of current density in relation to fish length and water temperature on mortality of salmon fingerlings

Current density	Temperature (° C.)	Fish length of—											
		4 to 5.9 cm.			6 to 7.9 cm.			8 to 9.9 cm.			10 to 11.9 cm.		
		Number exposed	Number dead	Mortality (percent)	Number exposed	Number dead	Mortality (percent)	Number exposed	Number dead	Mortality (percent)	Number exposed	Number dead	Mortality (percent)
0.17 milliamperes/cm ²	10.0-19.9	157	1	0.6				11	0	0			
0.21 milliamperes/cm ²	20.0-25.0	17	0	0	66	0	0	10	0	0			
0.22 milliamperes/cm ²	10.0-19.9	53	0	0	89	2	2.2	81	6	7.3	100	6	6.0
0.27 milliamperes/cm ²	20.0-25.0	15	0	0	58	0	0	28	5	17.9	14	0	0
0.31 milliamperes/cm ²	20.0-25.0	39	1	2.6	44	0	0						
0.33 milliamperes/cm ²	10.0-19.9	68	0	0	111	2	1.8	77	3	3.9	13	2	15.4
0.41 milliamperes/cm ²	20.0-25.0	96	5	5.2	207	34	11.5	50	9	18.0	11	0	0
0.53 milliamperes/cm ²	10.0-19.9				89	9	10.1	34	3	8.8			
0.61 milliamperes/cm ²	20.0-25.0	25	1	4.0	156	13	8.3	54	15	27.8	48	6	12.5
0.72 milliamperes/cm ²	10.0-19.9	23	3	13.0	83	4	4.8	81	6	7.4	28	0	0
0.78 milliamperes/cm ²	20.0-25.0	41	11	26.8	108	33	31.5	45	20	44.4	10	1	10.0
1.13 milliamperes/cm ²	10.0-19.9	19	11	57.8	60	10	14.5	120	5	4.2	34	2	5.9
1.21 milliamperes/cm ²	20.0-25.0	30	11	36.7	84	37	44.0	34	20	58.8	26	4	15.4
1.93 milliamperes/cm ²	10.0-19.9	20	15	75.0	20	9	45.0				12	1	8.3
1.93 milliamperes/cm ²	20.0-25.0	27	18	66.7	59	29	49.2	19	13	68.2			

The data, although there is considerable scatter, particularly where only small numbers of fish are used, show a pattern similar to that in the experiments in which both current density and voltage gradient were varied. Above a certain threshold mortality increased in proportion to the increase in current density, and there was no discernible relation between fish length and the effect of current density under the conditions of the experiments. The range of water temperatures in which the experiments were run was so great that the data were divided into two groups to reveal the influence of water temperature upon the mortality of fingerlings exposed to pulsating d. c.

The effect of voltage gradient in relation to

current density was calculated (fig. 6) from the combined effects of voltage gradient and current density (fig. 4) and from the effect of current density alone (fig. 5). Mortality is shown to be proportional to the voltage gradient. The relative influence of voltage gradient and current density under the experimental conditions is illustrated by the insert in figure 6.

During the tests, the fingerlings were held in uniform alinement with the direction of the electrical field (see Procedure). This subjected the longer fish to a greater difference in potential. When the data shown in figure 4 are replotted in terms of the total voltage to which the fish were subjected (fish length \times voltage gradient), they

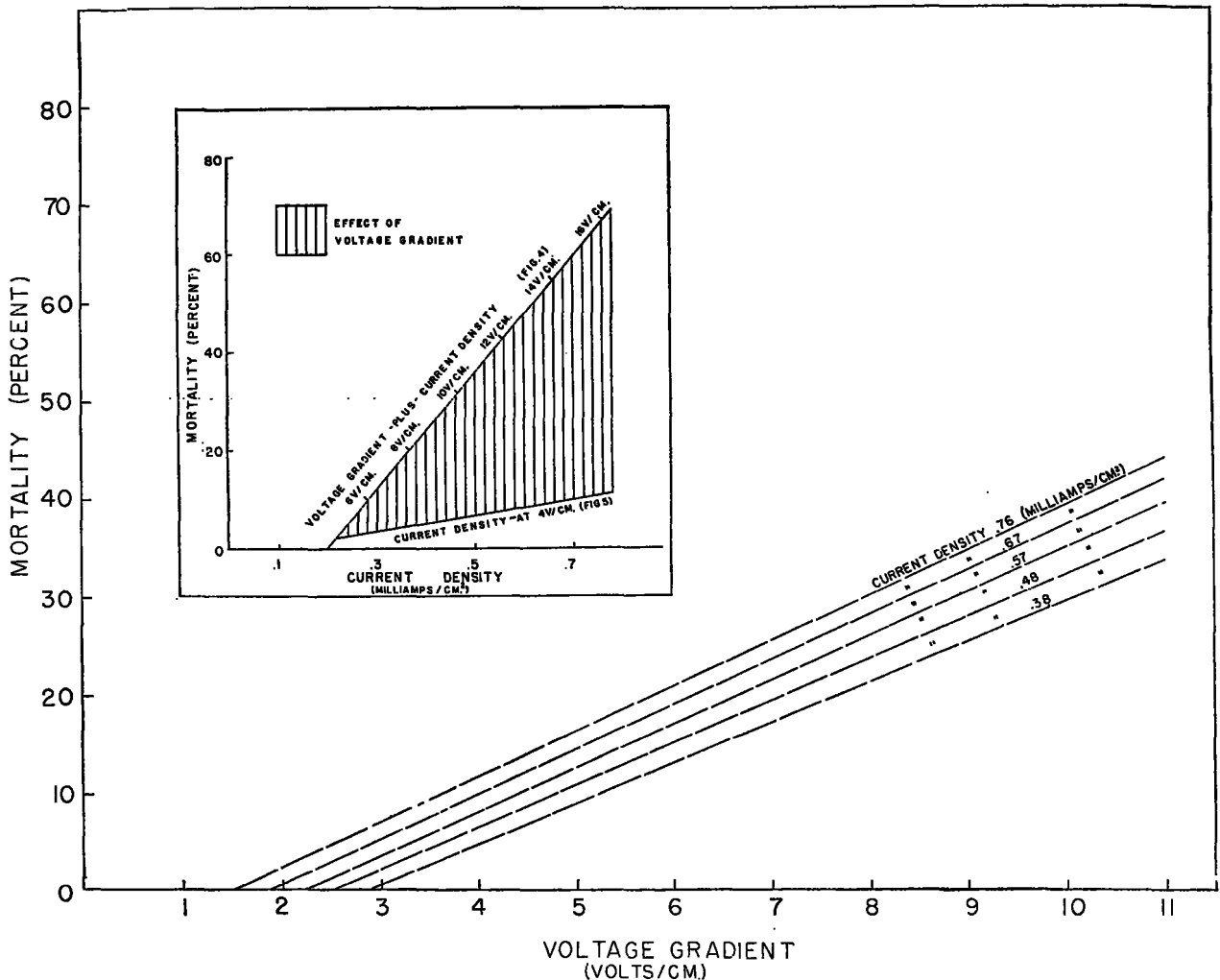

FIGURE 6.—Effect of voltage gradient in relation to current density upon mortality of salmon fingerlings (*Oncorhynchus tshawytscha*) exposed to pulsating d. c. calculated (see insert) from the combined effects of voltage gradient and current density (fig. 4) and the effect of current density (fig. 5).

indicate that the shorter fish are actually affected to a greater degree (fig. 7).

To determine whether the voltage gradient or the total voltage to which the fish were subjected was the effective factor, a group of tests was made with silver salmon (*O. kisutch*) in which the mortality of fingerlings alined parallel to the electrical field was compared with the mortality of fingerlings alined perpendicular to the field. Evidence (table 3) that the total voltage to which the fish were subjected is the effective factor in mortality was very conclusive. Electrical conditions that proved fatal to 77.6 percent of the fingerlings alined parallel to the field had no discernible injurious effect on fingerlings alined perpendicular to the field.

Experiments made to examine the effect of duration of exposure upon fingerlings subjected to pulsating d. c. in relation to the combined influence of voltage gradient and current density are summarized in figure 8, and the numerical data are shown in table 4. During these tests, pulse frequency, pulse duration, water temperature, water resistance, and fish length were maintained constant. Similar experiments examining the effect of duration of exposure in relation to current density alone are shown in figure 9, and the numerical data are listed in table 5. In these tests, pulse frequency, pulse duration, voltage gradient, water temperature, and fish size were held constant while the resistance of the water was modified.

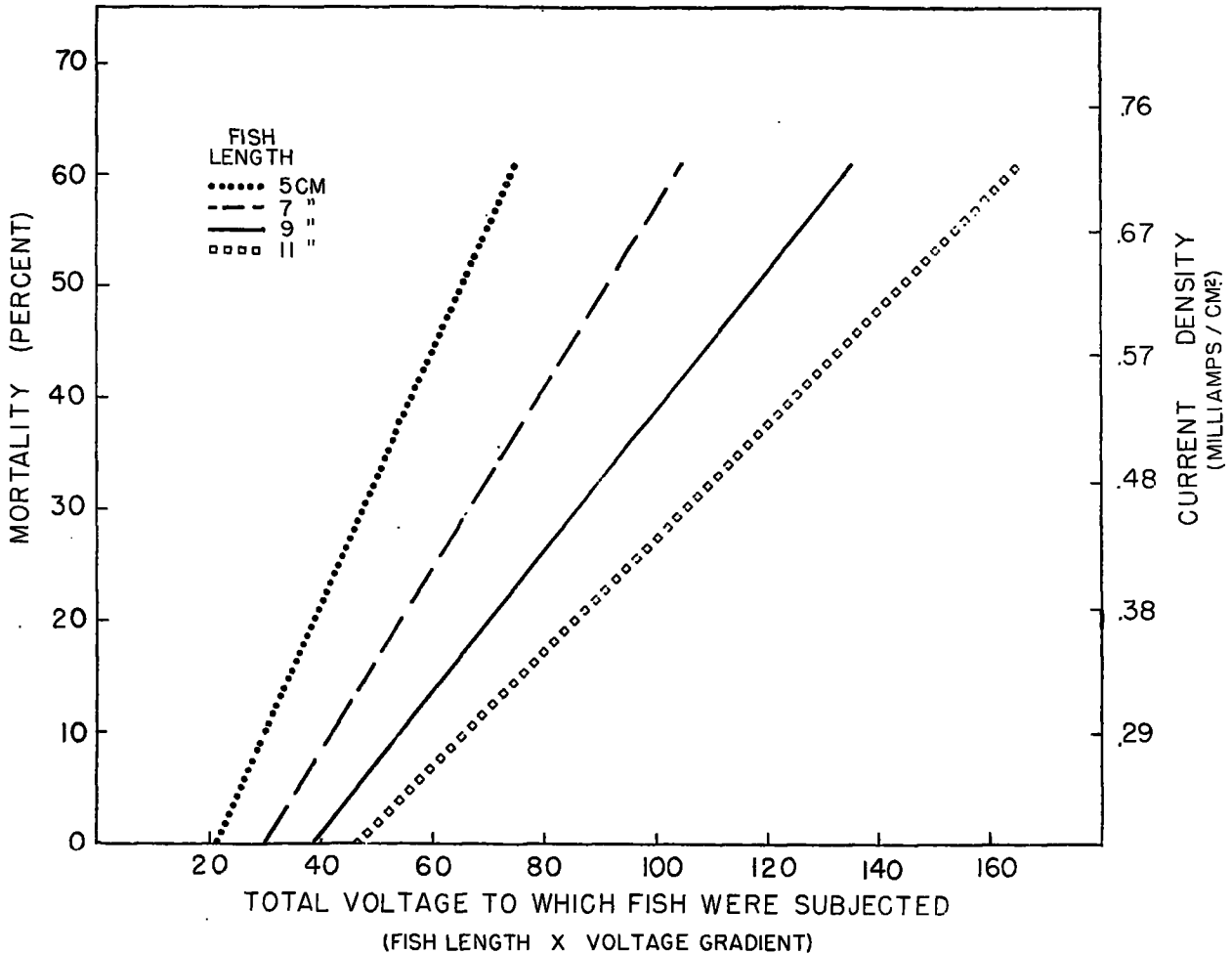

FIGURE 7.—Effect of the total voltage to which the fish were subjected in relation to fish length and current density upon mortality of salmon fingerlings (*Oncorhynchus tshawytscha*) exposed to pulsating d. c. (fig. 4 replotted in terms of the total voltage to which fish were subjected).

TABLE 3.—*Relative effects of voltage gradient and total voltage to which fish were subjected on mortality of salmon fingerlings (Oncorhynchus kisutch) exposed to pulsating d. c.*

[Tests run at 8 pulses/sec., pulse duration 40 milliseconds, water temperature 16.5° C., duration of exposure 1 minute; fish length, 7 cm.]

Fish alignment relative to electrical field	Voltage gradient (volts/cm.)	Total voltage to which fish were subjected	Number exposed	Number dead	Mortality (percent)
Parallel.....	6	1 42	107	83	77.6
Perpendicular.....	6	2 6	105	0	0

¹ Fish length × voltage gradient.

² Fish width × voltage gradient.

The results of both groups of experiments indicate, as would be expected, that the mortality of fingerlings exposed to pulsating d. c. is proportional to the duration of exposure. The results further suggest that the effect of voltage gradient increases with the duration of exposure while the effect of current density may actually decrease with an increase in duration of exposure. However, because of the scatter in the data, additional evidence should be obtained to substantiate this latter conclusion.

TABLE 4.—*Effect of duration of exposure in relation to the combined effects of voltage gradient and current density on mortality of salmon fingerlings*

Duration of exposure	Fish exposed to—								
	1 v./cm. and 0.05 ma./cm. ²			2 v./cm. and 0.10 ma./cm. ²			4 v./cm. and 0.19 ma./cm. ²		
	Number exposed	Number dead	Mortality (percent)	Number exposed	Number dead	Mortality (percent)	Number exposed	Number dead	Mortality (percent)
0.5 min.....							241	3	1.2
1 min.....							198	9	4.5
2 min.....							179	8	4.5
3 min.....				31	0	0	84	7	8.3
4 min.....				16	0	0			
5 min.....				63	4	6.4	98	12	12.3
6 min.....							99	17	17.2
7 min.....							99	19	19.2
7.5 min.....				52	6	11.5			
8 min.....							142	38	26.8
9 min.....							129	41	31.8
10 min.....				37	12	32.4	125	65	52.0
11 min.....							23	9	39.1
12 min.....							25	12	48.0
13 min.....							17	13	76.5
15 min.....	48	1	2.1	20	6	30.0			
20 min.....	117	20	17.1						

TABLE 5.—*Effect of duration of exposure in relation to current density on mortality of salmon fingerlings*

Duration of exposure	Fish exposed to—					
	0.10 ma./cm. ²			0.17 ma./cm. ²		
	Number exposed	Number dead	Mortality (percent)	Number exposed	Number dead	Mortality (percent)
2 min.....				46	2	4.4
3 min.....				40	3	6.1
3.5 min.....	58	2	3.5			
4 min.....	45	1	2.2			
5 min.....	27	3	11.1	16	7	43.6
7.5 min.....	67	9	13.3	55	15	36.8
10 min.....	65	21	32.3	19	11	58.0
	27	16	59.3	25	12	48.0

PULSE FREQUENCY

The effect of pulse frequency in relation to fish length upon mortality of fingerlings exposed to pulsating d. c. was examined experimentally by subjecting fingerlings of different lengths to a range of pulse frequencies while the voltage gradient, current density, pulse duration, water temperature, and the duration of exposure remained constant.

The data summarized in figure 10 (numerical data shown in table 6) reveal that the mortality

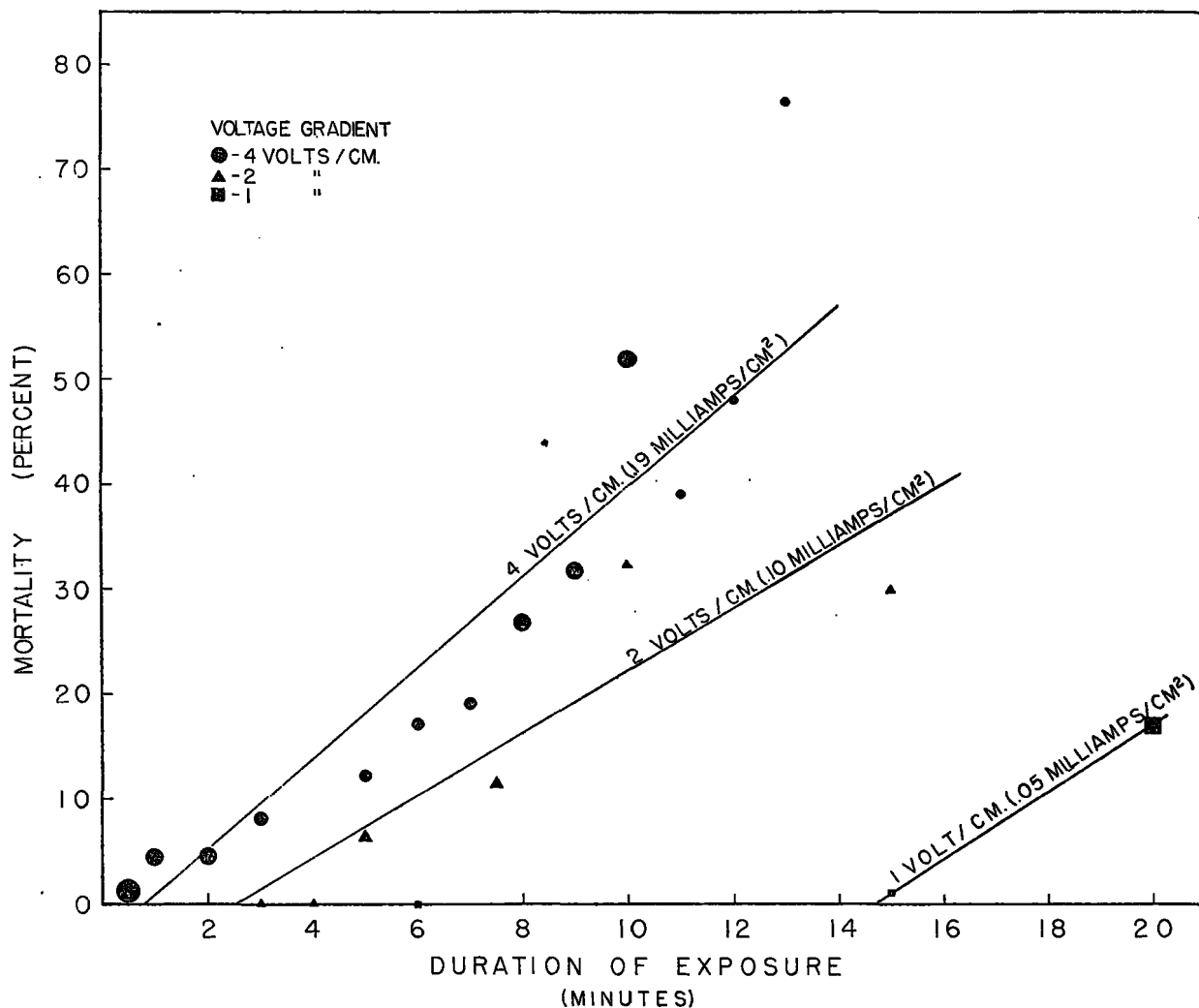

FIGURE 8.—Effect of duration of exposure in relation to the combined effects of voltage gradient and current density upon mortality of salmon fingerlings (*Oncorhynchus tshawytscha*) exposed to pulsating d. c. Tests run at 2 pulses/sec., pulse duration 20 millisees., temperature 10.0° to 19.9° C., fish length 7 cm. Sizes of symbols correspond to fish number categories: 17-49, 50-99, 100-199 and 200-241.

of salmon fingerlings exposed to pulsating d. c. increases with the pulse frequency and that the effect of pulse frequency upon mortality increases with the length of the fingerlings.

The relation of pulse frequency to the effect of duration of exposure was explored in the group of tests summarized in figure 11 (numerical data

are shown in table 7). Fingerlings were exposed to a pulsating d. c. field for various lengths of time at two different pulse frequencies while the voltage gradient, current density, pulse duration, and water temperature were held constant. The effect of pulse frequency upon mortality was found to increase with the duration of exposure.

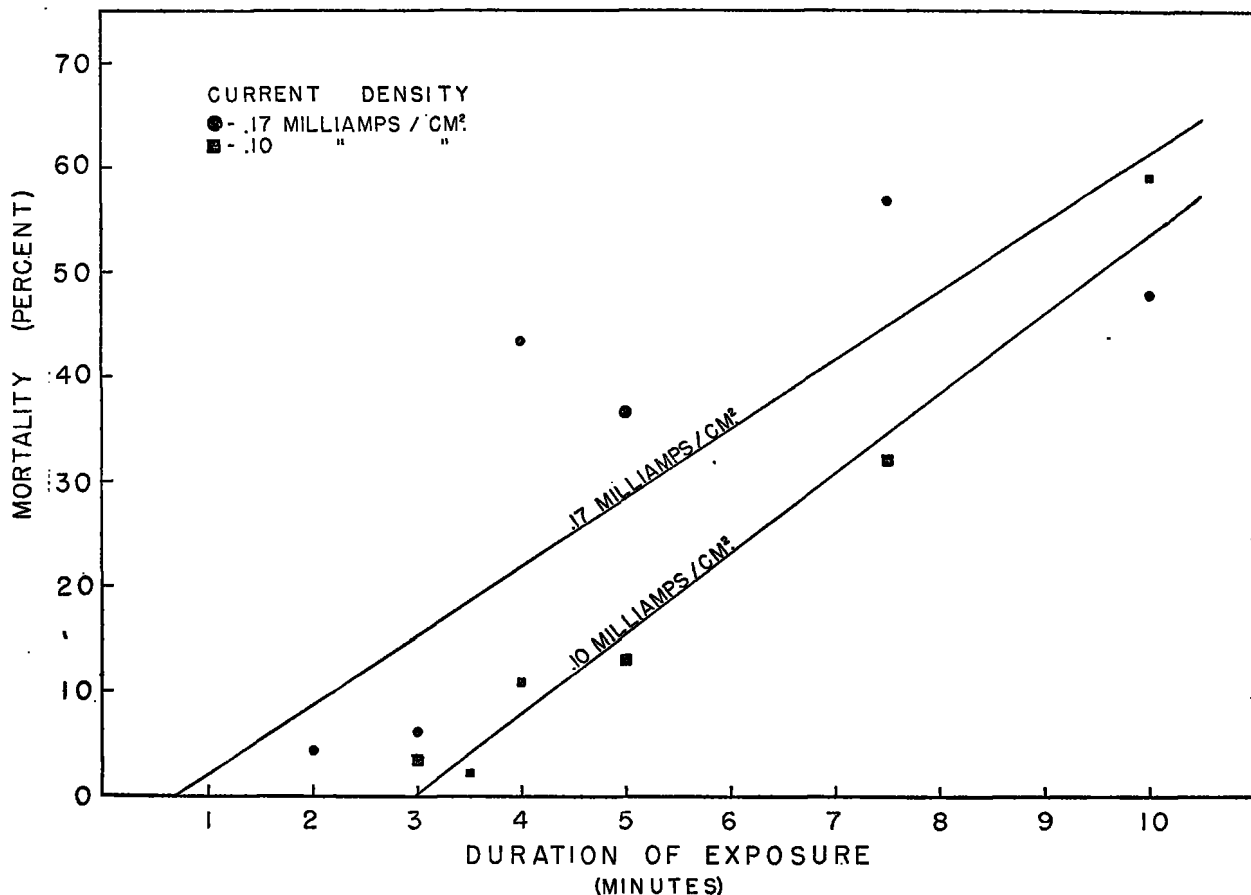

FIGURE 9.—Effect of duration of exposure in relation to current density upon mortality of salmon fingerlings (*Oncorhynchus tshawytscha*) exposed to pulsating d. c. Tests run at 2 volts/cm., 2 pulses/sec., pulse duration 20 milliseconds, temperature range 10.0° to 19.9° C., fish length cm. Sizes of symbols correspond to fish number categories: 16–49 and 50–65.

PULSE DURATION

To study the relation of pulse duration to the effect of duration of exposure upon the mortality of fingerlings exposed to pulsating d. c., tests were run in which fingerlings were subjected to different pulse durations while the voltage gradient and current density, pulse frequency, water temperature, and fish length were held constant. On their face, the data, graphically shown in figure 12 and numerically presented in table 8, suggest that pulses of long duration may be less injurious than pulses of short duration.

Since the tests with the 20-millisecond pulse duration and the tests with the 80-millisecond pulse duration were made several days apart and with fish from two sources, an experimental check was made (see circle, fig. 12) testing fish from only one source on the same day. Fingerlings used in this experimental check were from the group of fish used in the 80-millisecond pulse-duration tests. The results of the check fall along the trend of the 80-millisecond pulse-duration tests, indicating that the difference shown between the reaction to the 20-millisecond and to the 80-millisecond pulse duration is probably due to

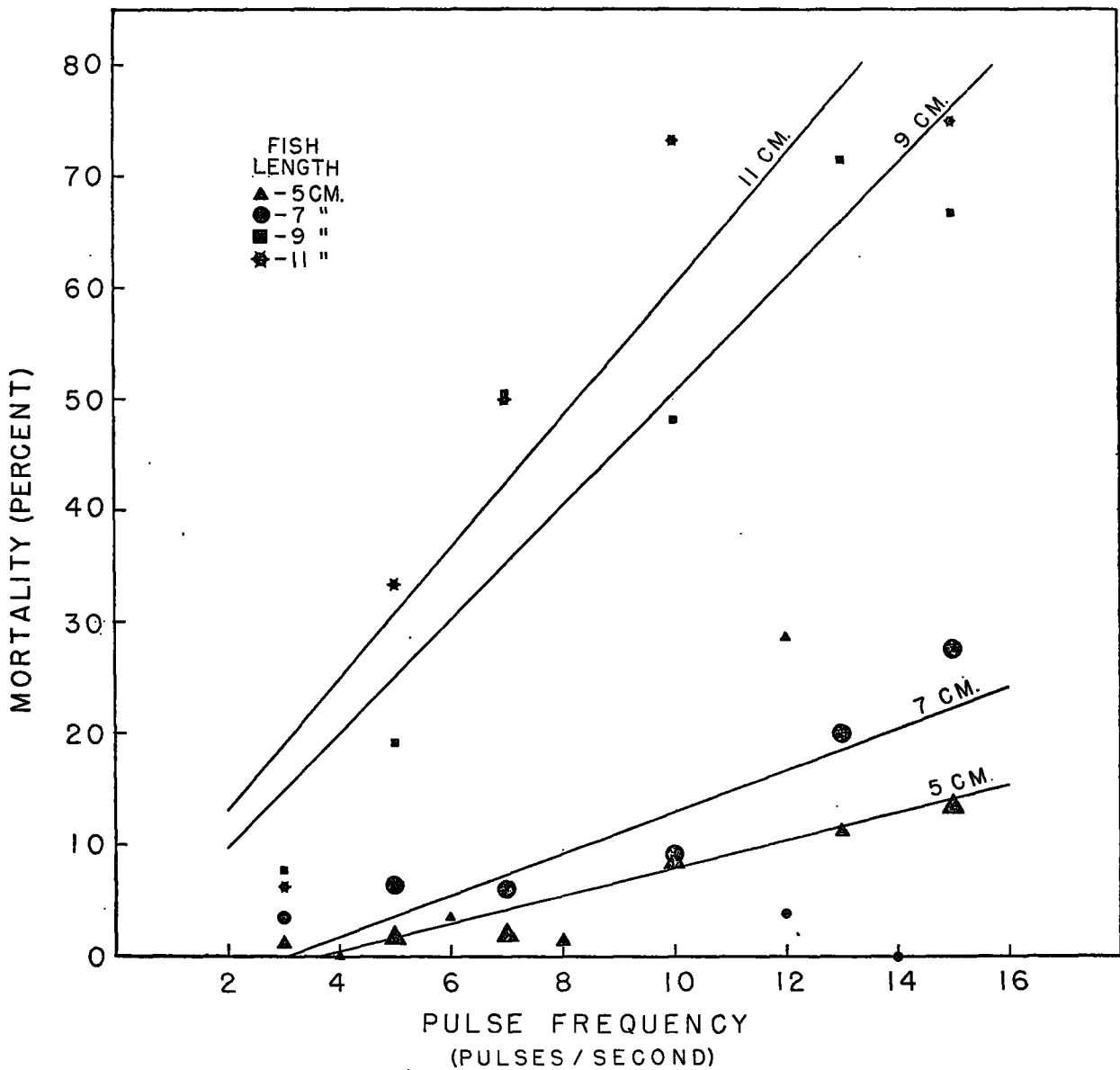

FIGURE 10.—Effect of pulse frequency in relation to fish length upon mortality of salmon fingerlings (*Oncorhynchus tshawytscha*) exposed to pulsating d. c. Tests run at 4 volts/cm., current density range 0.15 to 0.27 milliamps./cm.², pulse duration 20 millisechs., temperature range 10.0° to 19.9° C., duration of exposure 30 seconds. Sizes of symbols correspond to fish number categories: 10-49, 50-99, and 100-199.

TABLE 6.—Effect of pulse frequency in relation to fish length on mortality of salmon fingerlings

Pulse frequency	Fish length of—											
	4 to 5.9 cm.			6 to 7.9 cm.			8 to 9.9 cm.			10 to 11.9 cm		
	Number exposed	Number dead	Mortality (percent)	Number exposed	Number dead	Mortality (percent)	Number exposed	Number dead	Mortality (percent)	Number exposed	Number dead	Mortality (percent)
3 pulses/sec.....	92	1	1.1	59	2	3.4	26	2	7.7	16	1	6.3
4 pulses/sec.....	10	0	0									
5 pulses/sec.....	187	3	1.6	125	8	6.4	26	5	19.2	12	4	33.3
6 pulses/sec.....	29	1	3.5									
7 pulses/sec.....	107	2	1.8	133	8	6.0	30	15	50.0	18	9	50.0
8 pulses/sec.....	77	1	1.3									
10 pulses/sec.....	199	17	8.5	158	14	8.9	27	13	48.2	15	11	73.3
12 pulses/sec.....	14	4	28.6	26	1	3.8						
13 pulses/sec.....	98	11	11.2	170	34	20.0	35	25	71.4			
14 pulses/sec.....				24	0	0						
15 pulses/sec.....	178	24	13.5	170	47	27.6	27	18	66.7	12	0	75.0

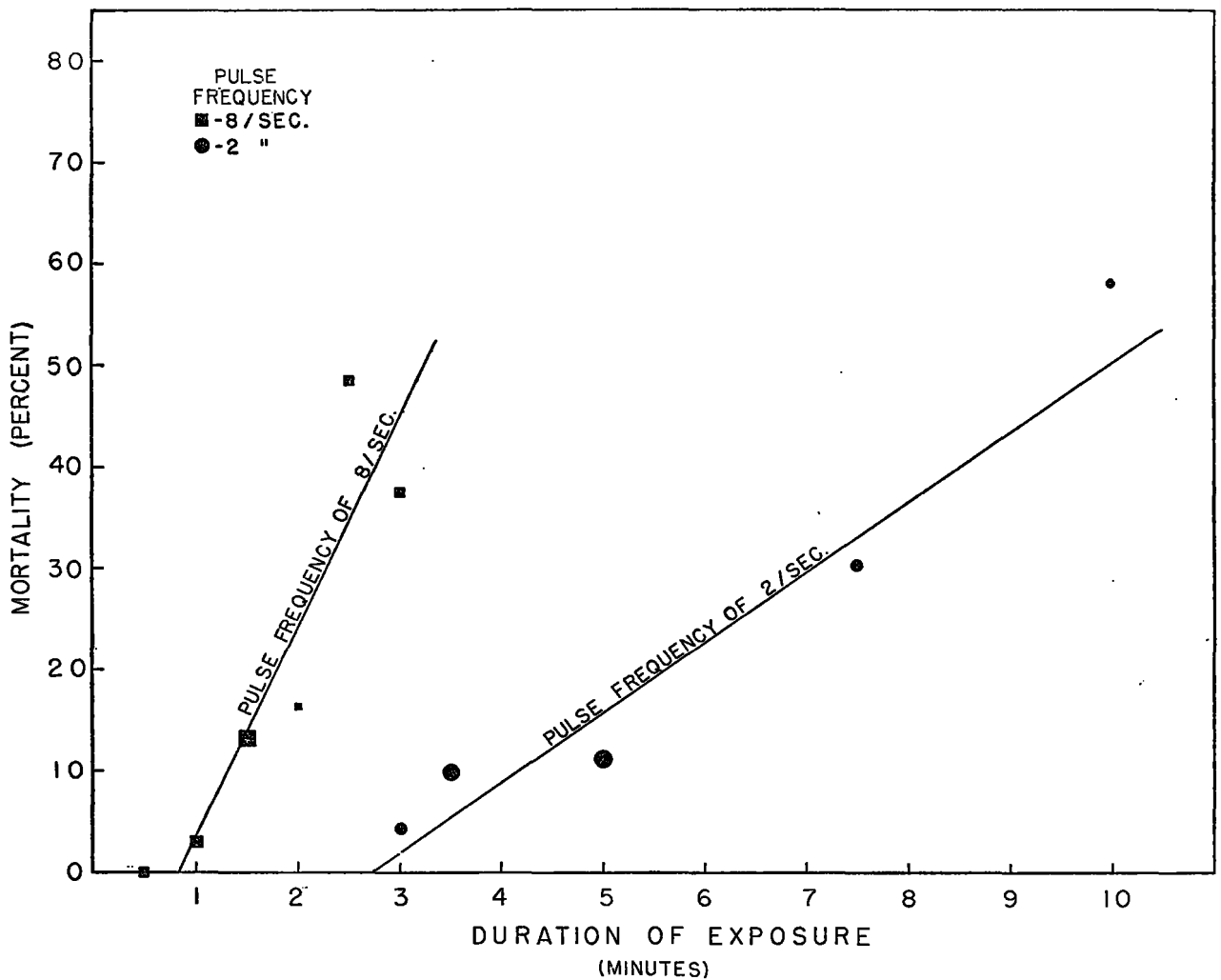

FIGURE 11.—Effect of duration of exposure in relation to pulse frequency upon mortality of salmon fingerlings (*Oncorhynchus tshawytscha*) exposed to pulsating d. c. Tests run at 2 volts/cm., current density range 0.08 to 0.13 milliamps./cm.², pulse duration 20 millisees., temperature range 12.0° to 19.9° C., fish length 9 cm. Sizes of symbols correspond to fish number categories: 27-49, 50-99, and 100-111.

TABLE 7.—Effect of duration of exposure in relation to pulse frequency on mortality of salmon fingerlings

Duration of exposure	Fish exposed to pulse frequency of—					
	2 pulses/sec.			8 pulses/sec.		
	Number exposed	Number dead	Mortality (percent)	Number exposed	Number dead	Mortality (percent)
0.5 min				71	0	0
1.0 min				65	2	3.1
1.5 min				105	14	13.3
2.0 min				49	8	16.3
2.5 min				58	28	48.3
3.0 min	69	3	4.4	64	24	37.5
3.5 min	101	10	9.9			
5.0 min	171	19	11.1			
7.5 min	69	21	30.4			
10.0 min	36	21	58.3			

TABLE 8.—Effect of duration of exposure in relation to pulse duration on mortality of salmon fingerlings

Duration of exposure	Fish exposed to pulse duration of—					
	20 milliseconds			80 milliseconds		
	Number exposed	Number dead	Mortality (percent)	Number exposed	Number dead	Mortality (percent)
0.5 min	71	0	0			
1.0 min	14	0	0	50	2	4.0
1.5 min	58	11	19.6	49	5	10.1
2.0 min	48	8	17.4	48	7	14.6
2.5 min	58	28	48.2			
3.0 min	15	8	53.3	45	17	37.8

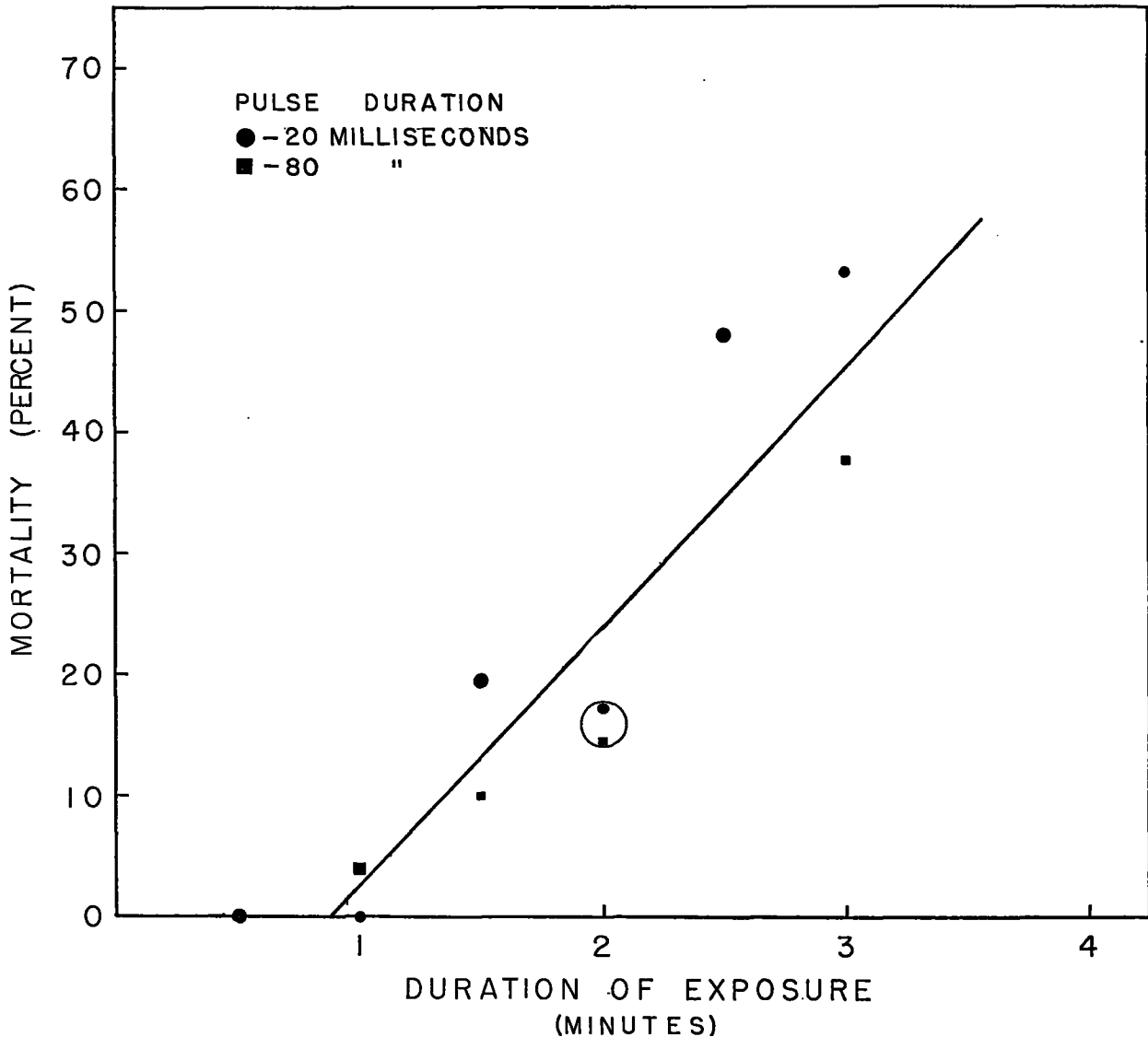

FIGURE 12.—Effect of duration of exposure in relation to pulse duration upon mortality of salmon fingerlings (*Oncorhynchus tshawytscha*) exposed to pulsating d.c. Tests run at 2 volts/cm., current density 0.10 milliamps./cm.², 8 pulses/sec., temperature range 10.0° to 16.0° C., fish length 9 cm. For explanation of circled data see text. Sizes of symbols correspond to fish number categories: 14-49 and 50-58.

variation in condition of the two groups of fish. Therefore, the data are interpreted (as shown in fig. 12) to mean that under the conditions of these experiments the pulse duration has no relation to the effect of the duration of exposure upon mortality of fingerlings exposed to pulsating d. c.

An examination of the data thus interpreted

shows that the mortality of fingerlings exposed to a pulse duration of 20 milliseconds at a frequency of 8 pulses per second (power on 16 percent of the time) is equal to the mortality of fingerlings exposed under similar conditions to a pulse duration of 80 milliseconds at a frequency of 8 pulses per second (power on 64 percent of the time). It is

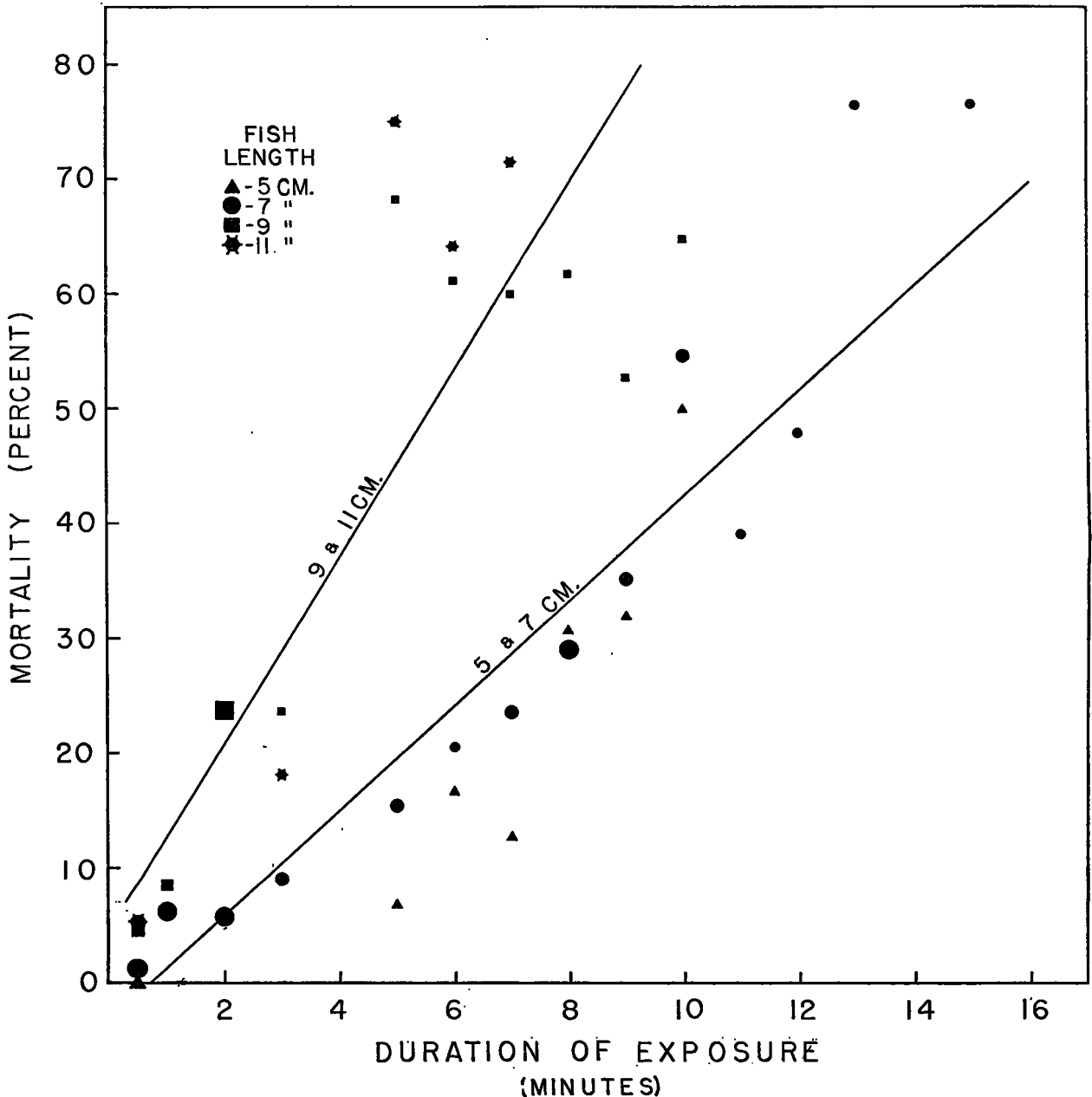

FIGURE 13.—Effect of duration of exposure in relation to fish length upon mortality of salmon fingerlings (*Oncorhynchus tshawytscha*) exposed to pulsating d. c. Tests run at 4 volts/cm., current density range 0.14 to 0.27 milliamps./cm.², 2 pulses/sec., pulse duration 20 millisecs., temperature range 15.0° to 19.9° C. Sizes of symbols correspond to fish number categories: 11-49, 50-99, and 100-154.

TABLE 9.—Effect of duration of exposure in relation to fish length on mortality of salmon fingerlings

Duration of exposure	Fish length of—											
	4 to 5.9 cm.			6 to 7.9 cm.			8 to 9.9 cm.			10 to 11.9 cm.		
	Number exposed	Number dead	Mortality (percent)	Number exposed	Number dead	Mortality (percent)	Number exposed	Number dead	Mortality (percent)	Number exposed	Number dead	Mortality (percent)
0.5 min	92	0	0	154	2	1.3	65	3	4.6	56	3	5.4
1.0 min				126	8	6.3	93	8	8.5			
2.0 min				122	7	5.7	105	25	23.8			
3.0 min				77	7	9.1	21	5	23.8	11	2	18.2
4.0 min												
5.0 min	29	2	6.9	71	11	15.5	19	13	68.3	16	12	75.0
6.0 min	18	3	16.7	68	14	20.6	18	11	61.2	14	9	64.2
7.0 min	31	4	12.9	76	18	23.7	20	12	60.0	14	10	71.5
8.0 min	26	8	30.8	113	33	29.2	21	13	61.9			
9.0 min	25	8	32.0	99	35	35.3	17	9	52.9			
10.0 min	12	6	50.0	99	54	54.6	20	13	64.9			
11.0 min				23	9	39.1						
12.0 min				25	12	48.0						
13.0 min				17	13	76.5						
14.0 min												
15.0 min				17	13	76.5						

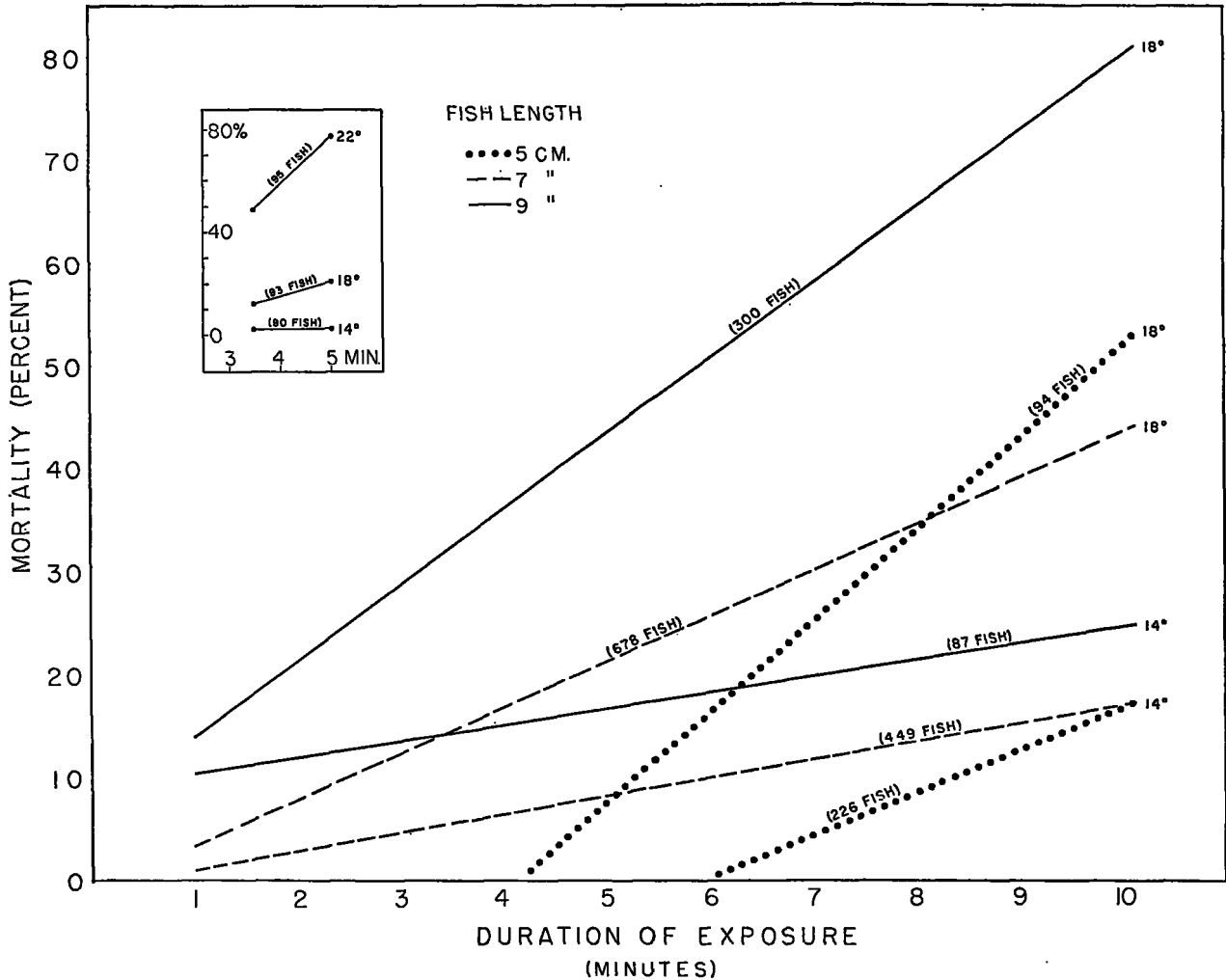

FIGURE 14.—Effect of duration of exposure in relation to temperature and fish length upon mortality of salmon fingerlings (*Oncorhynchus tshawytscha*) exposed to pulsating d. c. Tests run at 4 volts/cm., current density range 0.14 to 0.27 milliamps./cm.², 2 pulses/sec., pulse duration 20 milliseconds. (Insert: tests run at 2 volts/cm., current density range 0.09 to 0.11 milliamps./cm.², 2 pulses/sec., pulse duration 20 milliseconds., fish length 9 cm.)

TABLE 10.—Effect of duration of exposure in relation to temperature and fish length on mortality of salmon fingerlings

Duration of exposure	Fish length of—								
	4 to 5.9 cm.			6 to 7.9 cm.			8 to 9.9 cm.		
	Number exposed	Number dead	Mortality (percent)	Number exposed	Number dead	Mortality (percent)	Number exposed	Number dead	Mortality (percent)
1 minute:									
14° C									
18° C	15	0	0	83	1	1.2	160	0	0
2 minutes:									
14° C	12	0	0	115	8	7.0	84	8	9.5
18° C	14	0	0	77	2	2.6	67	8	11.9
3 minutes:									
14° C	10	0	0	102	6	5.9	98	22	22.5
18° C	8	0	0	27	0	0	3	0	0
4 minutes:									
14° C	18	0	0	57	7	12.3	19	5	26.3
18° C									
5 minutes:									
14° C							6	2	33.3
18° C									
6 minutes:									
14° C	52	0	0	21	1	4.8	4	1	25.0
18° C	21	2	9.5	51	11	21.6	17	12	70.6
7 minutes:									
14° C	55	2	3.6	53	8	15.1	3	1	33.3
18° C	12	2	16.7	46	9	19.6	5	3	60.0
8 minutes:									
14° C	60	1	1.7	48	4	8.3	2	0	0
18° C	17	3	17.7	51	15	29.4	19	12	63.2
9 minutes:									
14° C	47	3	6.4	52	9	17.3	2	1	50.0
18° C	20	8	40.0	90	26	28.9	20	13	65.0
10 minutes:									
14° C	51	6	11.8	49	11	22.9	11	1	100.0
18° C	13	5	38.5	81	30	37.0	17	9	52.9
11 minutes:									
14° C	13	2	26.3	40	21	52.5	6	1	16.7
18° C	11	6	54.6	85	44	51.8	15	12	80.0

¹ Data not included in calculation of curves.

concluded that pulse duration is not a lethal factor, at least within the range of conditions examined, and that there is no direct relation between mortality and the total energy applied per unit of time.

FISH LENGTH AND DURATION OF EXPOSURE

The relation of fish length to the effect of duration of exposure upon the mortality of chinook fingerlings exposed to pulsating d. c. was examined in a series of experiments in which fingerlings of different lengths were subjected for various periods of time to a pulsating electrical field with voltage gradient, current density, pulse frequency, pulse duration, and water temperature held constant.

The data graphically presented in figure 13 and numerically shown in table 9 indicate that the effect of duration of exposure upon mortality increases with the length of the fish.

TEMPERATURE

The relation of water temperature to the effect of duration of exposure on the mortality of chinook fingerlings subjected to pulsating d. c., was demonstrated by a group of experiments in which fingerlings of different lengths were subjected to pul-

sating d. c. at different water temperatures for various lengths of time. During these tests, voltage gradient, current density, pulse duration, and pulse frequency were held constant.

The data graphically shown in figure 14 and numerically presented in table 10 reveal that above a certain threshold exposure the influence of water temperature on the mortality of chinook fingerlings exposed to pulsating d. c. increases with the duration of exposure and that the influence of water temperature upon mortality is greater upon longer fish. The pattern of response was verified (see insert, fig. 14) by testing fingerlings from a single source on the same day. The curves shown in the insert illustrate the greater effect of water temperature at higher temperature levels. The marked difference in mortality related to temperature in the current density experiments (fig. 5), where exposure to the electrical field was only 30 seconds, may have been due to the higher temperature levels involved.

DISCUSSION

The results of these experiments are in general agreement with the findings of other research workers investigating the effect of electric current on fish. McMillan's (1928) experiments with a. c.

showed an increase in mortality with an increase in voltage gradient and current density and with an increase in the duration of exposure. Similar results were obtained in the present study with pulsating d. c. That the total voltage received by the fish is the effective factor rather than the voltage gradient has been pointed out several times in the literature (Okada 1929, Bramsnaes et al. 1942, Kuroki 1951). The evidence indicating that shorter fish are affected to a greater degree by total voltage than longer fish (fig. 7) agrees with the findings of Kuroki, whose conclusions were based on a study of the reactions of *Carassius auratus* in approximately the same length range as those used in this study.

There is some evidence suggesting that the relation of fish length to the influence of total voltage upon mortality may be a function of the duration of exposure. Figure 7 indicates that shorter fish are more affected by the total voltage than longer fish when the exposure is only 30 seconds. A comparison, in terms of the total voltage to which the fish were subjected, of mortality of fingerlings of different lengths subjected to pulsating d. c. under almost similar conditions at exposures of 4 minutes and 8 minutes (figs. 8, 11, and 13), suggests that the relation may reverse with increased exposure. At a 4-minute exposure the effect of total voltage is approximately equal for fish of 7-cm. and 9-cm. lengths while with an 8-minute exposure the longer fish are affected to a greater degree. The data, however, do not make clear whether the increased mortality of the longer fish is due solely to the greater effect of total voltage upon longer fish with increased duration of exposure or to the increased effect of some other factor such as pulse frequency.

In several of the experiments that showed a significant relation between mortality and fish length (see figs. 10, 13, and 14), the difference in mortality related to fish length was greater between the 7-cm. and 9-cm. lengths than it was between the 7-cm. and the 5-cm. lengths or between the 9-cm. and the 11-cm. lengths. This suggests the possibility that the difference in mortality may also be a function of some other aspect of the size of fish such as the cross-sectional area of the body.

One of the relations brought out by the experiments is the influence of water temperature upon the mortality of fingerlings exposed to pulsating d. c. The importance of water temperature,

apart from its effect upon the resistance of water, is clearly shown by the marked increase in mortality occurring under similar electrical conditions with an increase of a few degrees in water temperature (see figs. 5 and 14). The experience of Larimore, Durham, and Bennett (1950) in stunning fish with an electric fish shocker indicates that the effect of temperature upon mortality shown in the laboratory experiments will also be found in the field. Larimore et al. found that during cold weather the speed of their collecting operation was slowed down because a longer exposure was required to stun the fish.

Since pulse duration does not appear to be a lethal factor and since there does not appear to be a direct relation between mortality and the total energy applied per unit of time, as contrasted with the marked effect of pulse frequency upon mortality, the evidence points to the probable importance of wave form. If the increased mortality caused by an increase in pulse frequency is not due to the increase in total energy applied per unit of time, it must be due to the increase in the number of changes in potential. If change in potential is the effective factor, then the rate of change in potential should be of great importance.

The relation between mortality of the fish subjected to pulsating d. c. under the experimental conditions just described and mortality of wild fish subjected to pulsating d. c. under natural stream conditions must remain a matter of speculation until it is examined experimentally. Differences in the condition of wild fish and of hatchery fish might result in a marked difference in their ability to withstand subjection to electric current. The definition of mortality used in the laboratory experiments allowed 1 hour after exposure for recovery, during which time the fingerlings were held in aerated glass bowls. Whether the proportion of recoveries would be as great or greater under stream conditions where factors such as turbulence and predation would be in operation during that hour is open to conjecture.

In general, one might expect the greater mortality under the laboratory treatment. The fingerlings had to be netted several times, transported, held in tanks, and subjected to several complete water changes. During their exposure to the electrical field the fish were restricted by plastic stalls, and this may have resulted in some mechanical injury due to violent movements when

the current was first applied. The fingerlings were always held in alinement parallel to the direction of the electrical field (the one exception is noted on p. 69) and would therefore be continually subjected to a maximum voltage. In a stream the free-swimming fish may be alined directly parallel to the field for only a part of the total exposure.

Interpretation of the data from these laboratory experiments for use in electrical fish-guiding experiments in the field must take into consideration other factors as well. The maximum width of a directional electrified zone that could be used would be determined by the rate at which the fish swim out of the electrified zone and by the maximum duration of exposure that is "safe" for the fish. Assuming that the fingerlings are distributed at random throughout the stream, only those fish entering at the extreme negative end of the electrified zone would be subjected to the entire width of the zone in moving to the positive end. Thus, a 15-percent expected mortality for those fish exposed to the maximum field width may represent only a negligible mortality in terms of the total number of fish being directed by the electrified zone. It may be possible to safely direct fingerlings in ranges of electrical conditions which produced a mortality of 30 or 40 percent in the laboratory experiments. One of the tasks of field experiments in electrical fish guiding will be to determine the relation between mortality under standardized laboratory conditions and that under conditions in the stream.

The experiments reported here emphasize one point—a significant part of the ranges of electrical characteristics desirable in fish guiding are lethal to some degree for salmon fingerlings. The possibility of injurious effects of a nonvisible nature (e. g., an effect upon reproductive ability) is being explored. Although this study is not yet complete enough to draw many conclusions, it is clear that the application of the principle of electro-taxis to the protection of salmon fingerlings will require an intimate knowledge of the relation between the electrical-energy levels producing electro-taxis and those detrimental to the fish.

SUMMARY

The influence of voltage gradient, current density, pulse frequency, and duration of exposure

upon the mortality of salmon fingerlings exposed to pulsating direct current was examined experimentally in relation to the length of fish, water temperature, and pulse duration. A current of square-wave form was used and the following ranges were explored: Voltage gradient, 0.5 to 15 volts/cm.; pulse frequency, 2 to 15/sec.; pulse duration, 20 to 80 milliseconds; current density, 0.05 to 1.9 milliamps./cm.²; duration of exposure, 0.5 to 20 minutes; fingerling lengths, 4 to 12 cm.; and temperature, 10° to 25° C.

For simplification, the assumption was made that a straight line of regression was the most satisfactory description of the relations examined, and the results of the experiments, above threshold values, were interpreted as follows:

1. Mortality increased in a constant ratio with an increase in voltage gradient, an increase in current density, or an increase in both. The effect of voltage gradient increased with the duration of exposure.

2. The total voltage to which the fish were subjected (i. e., fish length \times voltage gradient) was the effective factor in mortality rather than the voltage gradient, and the effect of total voltage upon mortality was actually greater on the shorter fish when the exposure was only 30 seconds.

3. Fingerlings exposed to a pulse of 20 milliseconds at a frequency of 8/sec. (power on 16 percent of the time) had the same mortality as fingerlings exposed under similar conditions to a pulse of 80 milliseconds duration at a frequency of 8/sec. (power on 64 percent of the time), indicating that under the conditions of the experiment pulse duration was not a lethal factor and that there was no direct relation between mortality and the total energy applied per unit of time.

4. Mortality increased with the pulse frequency, and the effect of pulse frequency upon mortality increased with the length of fish and the duration of exposure.

5. Mortality of fingerlings exposed to pulsating d. c. increased with the duration of exposure, and the effect of duration of exposure increased with the length of the fingerlings.

6. Mortality increased with the water temperature, and the effect of water temperature upon mortality increased with the duration of exposure. The effect of water temperature upon mortality was greater on fish of greater length.

LITERATURE CITED

- BRAMSNAES, FRODE, MORGENS JUL, and C. V. OTTERSTRØM.
1942. Barriers against fish by means of electricity or veils of air. Rept. Danish Biol. Sta. No. 47, pp. 39-46.
- GROODY, TOM, ANATOLE LOUKASHKIN, and NORMAN GRANT.
1950. Electrical stimulation of fish in sea water. California Coop. Sardine Research Program, Progress Rept., pp. 46-47.
- KUROKI, TOSHIRO.
1951. Study on the electric fish screen. IV. The electrifying effects by 10-4 sec. order low frequency electric shocks upon fish bodies. Bull. Japanese Soc. Sci. Fish., vol. 18, No. 1 (1952), pp. 25-29. (Translated from the Japanese by Akira Ishimaru.)
- LARIMORE, R. WELDON, LEONARD DURHAM, and GEORGE W. BENNETT.
1950. A modification of the electric fish shocker for lake work. Jour. Wildlife Management, vol. 14, No. 3, pp. 320-323.
- McMILLAN, F. O.
1928. Electric fish screen. U. S. Bur. Fish. Bull., vol. 44, pp. 97-128.
- OKADA, MITUYO.
1929. On the action of electric current on fishes. Excitation and narcosis. Jour. Imperial Fish. Institute (Tokyo), vol. 24, No. 2, pp. 64-72.
- SCHEMINZKY, FERDINAND.
1924. Versuche über electrotaxis und electronarkose. Pflüger's Arch. für die gesamte Physiol. des Menschen und der Tiere, vol. 202, pp. 200-216.

