

# THE PHOTOGRAPHY OF AQUATIC ANIMALS IN THEIR NATURAL ENVIRONMENT

By JACOB REIGHARD

*Professor of Zoology, University of Michigan*

---

BUREAU OF FISHERIES DOCUMENT NO. 635



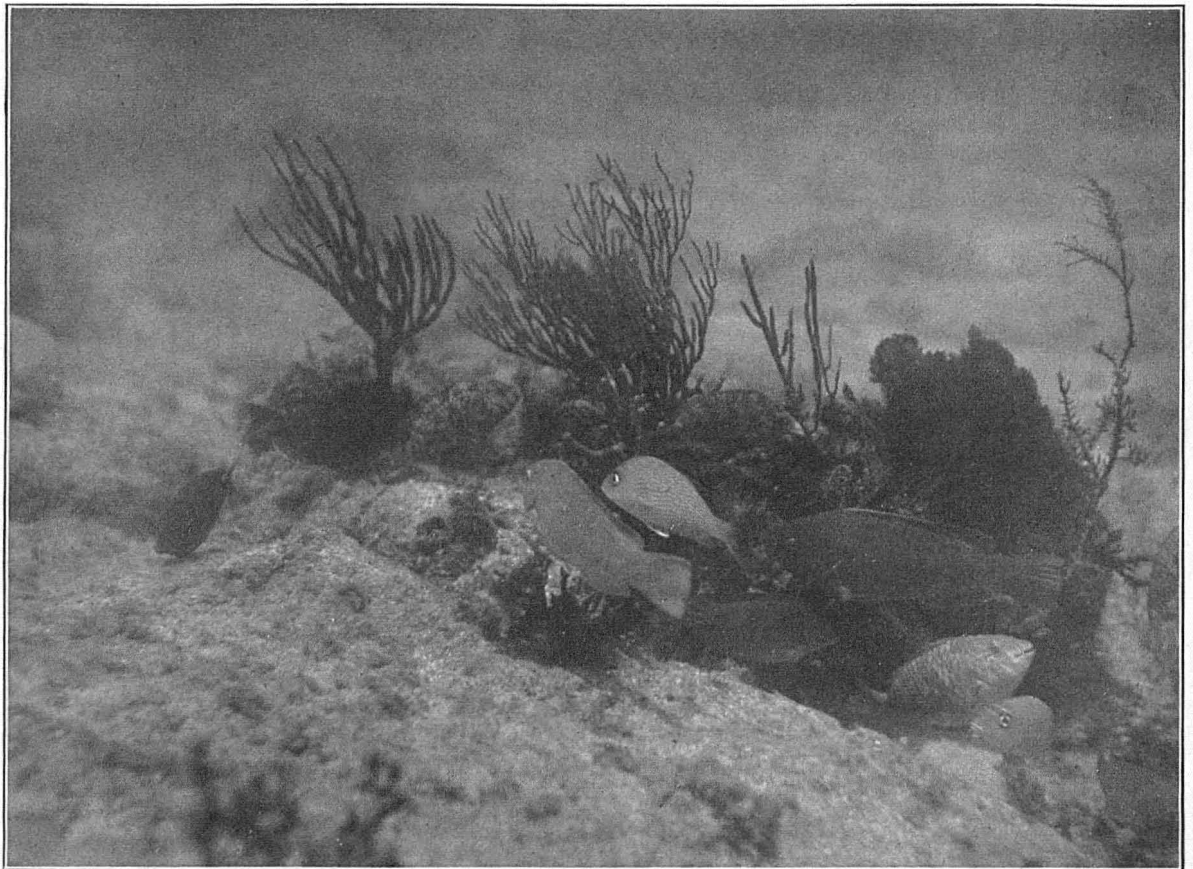

PHOTOGRAPHS TAKEN WITH CAMERA SUBMERGED.

The photographs shown in this plate are reproduced without retouching from originals made on orthochromatic plates with a color screen by the use of a reflecting camera inclosed in the water-tight box described in this paper. The exposures were made in sunlight in about 4 feet of water at 11 A. M. at Tortugas, Fla., and lasted  $\frac{1}{3}$  second. For further description see text, page 65.

# THE PHOTOGRAPHY OF AQUATIC ANIMALS IN THEIR NATURAL ENVIRONMENT.

By JACOB REIGHARD,  
*Professor of Zoology, University of Michigan.*

## INTRODUCTION.

Many things have contributed in recent years to extend the use of photography into fields of natural history not previously occupied by it. Dry plates and films have been made more rapid and, with the advent of the nonhalation and orthochromatic sorts, have been adapted to every use; with new sorts of optical glass it has been possible to construct photographic lenses of great speed; cameras and accessories have been made portable and suited to a variety of needs. As a result we find in scientific publications, as well as in more popular books and periodicals, excellent photographs of living animals and plants in their natural environment. Students and lovers of birds, field naturalists and hunters of big game have all contributed their part. Birds have been photographed on the wing and while engaged in their domestic duties, on the nest in almost inaccessible high trees, on mountain crags, and on the faces of cliffs. Mammals have been photographed in nature under a great variety of conditions. Reptiles, amphibians, insects—every variety of terrestrial animal has been pictured by the lens.

Quite in contrast has been the limited use of photography for aquatic organisms. Shufeldt (1898), Dugmore (Jordan & Evermann, 1902), Saville-Kent (1893), Fabre-Domergue (1898), have from time to time succeeded in making excellent photographs of animals in aquaria under more or less artificial conditions, but the work has been carried scarcely beyond this (see Boutan, 1893, 1898, 1898a, 1900, and Rudaux, 1908). The present paper deals rather with the photography of aquatic organisms, not merely in their native element, but in their native environment and under normal conditions. It attempts to show how they may be photographed, not by taking them from their native haunts and placing them in artificial containers, but by carrying the camera into the field. The methods described make it possible to do in some measure for aquatic animals what has been done for birds and other terrestrial forms.

## PRINCIPLES OF PHOTOGRAPHY OF SUBMERGED OBJECTS.

In air the naturalist can by one method or another photograph what he sees. When he looks into clear water he may see much that it seems possible to photograph. If the surface is disturbed objects beneath it appear distorted and wavering, but if the surface is smooth they may appear as sharp and steady as though

viewed through air alone. In the latter case the photographer may set up his camera and find that he can get a perfect image on the ground glass; but if he then exposes a plate with the expectation of getting a good negative he will be sorely disappointed. Only rarely does he get any image at all of what lies beneath the water's surface. Usually the negative shows only the surface itself, and that appears as opaque as though the camera had been pointed into a lake of tar. The writer has often attempted such photographs, to find on his negative no visible impression of the fish which showed so clear on his ground glass. This is doubtless a common experience. Why is it?

Explanation will be clearer by referring to the diagrammatic figure 1, where the camera (*c*) is pointed toward a fish (*x-y*) beneath the surface (*a-b*) of the water.

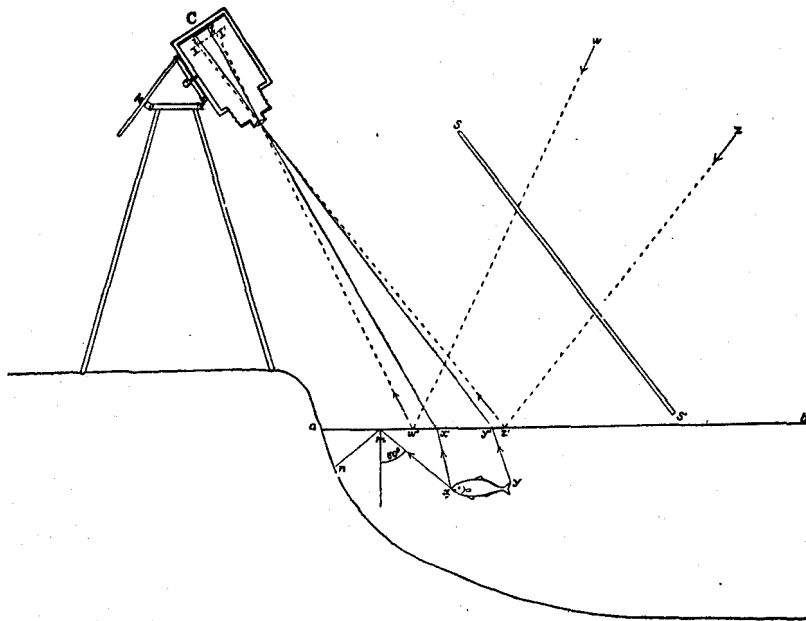

FIG. 1.—Diagram illustrating the photography of objects beneath the water by a camera above the surface. For explanation see the text.

The fish is illuminated chiefly by rays of light which enter the water almost vertically. The rays of light *x x'*, *y y'*, reflected from the fish, which strike the surface of the water from below at an angle less than  $48^{\circ}35'$  with the vertical, emerge into the air, while at the same time they are bent from their course, as shown in the figure. Some of

these rays converge to the lens, and thence diverge to form on the ground glass the image *i i'*. When the photographic plate is exposed these rays, with the rays from other submerged objects, form an image on it, as they do on the ground glass. Yet this image does not appear in the negative, for if the surface of the water is smooth it acts as a single great mirror which, although it permits a part of the light to penetrate, yet reflects another part, greater the more obliquely the light strikes the surface. For this reason the images of sky and trees and other distant objects are often seen mirrored on the surface of smooth water. Some of these reflected rays (*z z'*, *w w'*), after leaving the surface of the water, enter the lens of the camera and form an image. The fish is a near object and if the camera is focused upon it the image of the fish is sharp on the photographic plate. The reflected rays from the water's surface come usually from distant objects, commonly sky or clouds. When the camera is focused on the fish a sharp image

of these distant objects is formed, not on the photographic plate, but in a plane situated somewhere between that plate and the lens, as at  $I I'$ . After forming the image at  $I I'$  these rays again diverge and strike the photographic plate. The plate is thus flooded by light from distant objects that are wholly out of focus, so that such rays do not form a distinct image on it. This reflected light is usually brighter than the light which forms the image of the fish. It affects the plate with greater intensity, so that when the plate is developed the image of the fish is quite obscured by the general fog produced by the brighter light. There appears in the negative only a uniform dark haze, which represents the surface of the water.

If the ground glass is put in place and brought by focusing into the plane  $I I'$ , then the sharp image of distant clouds and trees is seen on it, while the image of the fish lies behind the ground glass and is no longer clearly visible. If the water is smooth, a plate exposed under these circumstances gives a sharp negative of these distant objects, but does not show the fish.

If one looks at the fish in the water from the point  $C$  it is seen clearly, because its image is focused on the retina, while the images of more distant objects mirrored in the water's surface fall in front of the retina, and the objects from which they come are therefore not seen. The observer neglects the glare of light from these distant objects, fixes his attention on the fish, and sees it. If now, while still looking toward the fish, he adjusts his eye to distant objects by relaxing the ciliary muscle, these are clearly seen mirrored in the surface of the water, while the fish is no longer sharply seen. Similarly, if a mirror is laid on the ground so as to reflect the clouds and its image is examined by focusing in a camera, it is impossible to get at the same time on the ground glass a sharp image of the clouds reflected in the mirror and of the frame of the mirror or other near object. It is only when the mirrored object lies near the surface of the water that its image can be focused on the photographic plate or retina at the same time with that of a submerged object near the surface. It nearly always happens that the light entering the camera from distant objects mirrored in the surface of the water is so much more intense than that from submerged objects that the images of the latter are quite obliterated on the photographic plate. Sometimes, on the other hand, when the camera is pointed nearly vertically into the water at an object over a light-colored bottom, the emerging light is more intense than the reflected light, and there is obtained a more or less fogged negative which shows submerged objects. This is the more apt to be the case if the photographer has the sun at his back. (See Saville-Kent, 1893.) At other times, within the limits of the reflected image (not the shadow) of a dark-colored bridge or building or of dense foliage, one may obtain a fogged negative, showing submerged objects. In this case also the partial success is due to the fact that the reflected light is less intense than that which comes from the submerged objects to be photographed. It is not often, however, that the submerged objects that one wishes to photograph are found within the reflected images of dark-colored backgrounds of sufficient size and far enough away.

The above discussion is based on the assumption that the surface of the water is smooth so that it acts as a single large mirror. If the water surface is disturbed it is broken into numerous smaller surfaces, concave, convex, or plane, and each of these acts as an independent small mirror. These form distorted images of

portions of distant objects, of natural size, magnified or reduced; and the light from them entering the camera affects the photographic plate in such a way as to obliterate the dimmer image of any object lying beneath the water. At the same time the light from the submerged object is refracted in various directions as it emerges into the air through the irregular surface of the water, so that its image as formed on the retina or ground glass is neither sharp nor steady.

From the foregoing discussion it appears that attempts to photograph submerged objects with a camera placed in air can result in only partial success, and this but rarely. Failure is due to the fact that the photograph is made through the surface of contact of two media, water and air, of very different refractive powers. If this surface is not perfectly smooth the light from an object beneath it is, upon emergence, refracted unequally at different parts of the surface and can not form a clear image on the ground glass. Whether the water is smooth or rough its surface reflects a part of the light which strikes it, and thus acts as a mirror. This reflected light makes it impossible, except under unusual conditions, to obtain photographs of submerged objects. To obtain such photographs the surface of the water must be smooth and light reflected from it must not enter the camera. Two modes of procedure suggest themselves:

(1) *The camera may remain above the surface of the water.* In that case the surface of disturbed water must be rendered smooth and the light from objects above water must be prevented from striking its surface at such angles as to enter the camera in sufficient amount to fog the plate. Methods devised by the writer for accomplishing these two results are taken up and illustrated in the following section.

(2) *The camera may be placed beneath the surface of the water,* so that this surface does not intervene between the camera and the object to be photographed. The light which enters the camera is therefore neither refracted nor reflected at this surface, and images may be obtained on the ground glass as clear and steady as though viewed through air alone. Methods of the writer and others for accomplishing this are described and illustrated in the final section of this paper.

#### **A NEW METHOD OF PHOTOGRAPHING SUBMERGED OBJECTS WITH THE CAMERA ABOVE THE SURFACE.**

It was pointed out in the preceding section that if the camera with which submerged objects are to be photographed is to remain above the surface of the water means must be found (1) greatly to reduce the amount of reflected light entering the camera from the surface of the water, and (2) to render the surface of the water smooth. We may consider first the case in which the surface of the water is smooth, so that it is necessary merely to minimize surface reflection.

The method to be described is best adapted to objects in water not more than 2 or 3 feet deep, and the best results are obtained when the water is less than a foot in depth. Any type of camera may be used, but since the objects to be photographed are necessarily quite near the camera they are out of focus with a fixed-focus camera, so that the best results are obtained when the camera is one that can be focused. Since the objects to be photographed are usually in motion, and since the surface of the water may at any time be roughened by a puff of wind,

it is best to use a lens suitable for instantaneous exposure—a lens of a speed not less than  $f\ 8$ . The operator should first select the point from which the picture is to be taken. He should, of course, have the sun at his back or to one side. If possible he should stand on the bank or on some fixed support which extends above the surface of the water. From such a position the camera is at a greater height and may usually be directed at the surface of the water at an angle of about  $45^\circ$  or less from a vertical extending upward from this surface. Rays of light from submerged objects striking the surface of the water from below at an angle of  $48^\circ\ 35'$  from a vertical drawn downward (or at a less angle), emerge. They may thus, after refraction, reach the camera as indicated by the line  $x\ x'\ i'$  in figure 1. Rays which strike the surface of the water from below at an angle of more than  $48^\circ\ 35'$  with the vertical are, on the other hand, reflected at the surface so that they do not emerge and enter the camera but pass down again into the water, as indicated by the line  $x\ m\ n$  in figure 1.

If the operator is unable to find a fixed emergent support for the camera he may make the exposure while standing in the water. The camera may then be held in the hand or may be supported on a tripod which rests on the bottom. As the legs of the tripod are likely to sink into the bottom they should be extended to their full length. Where the bottom is firm an elevated position may be obtained for the

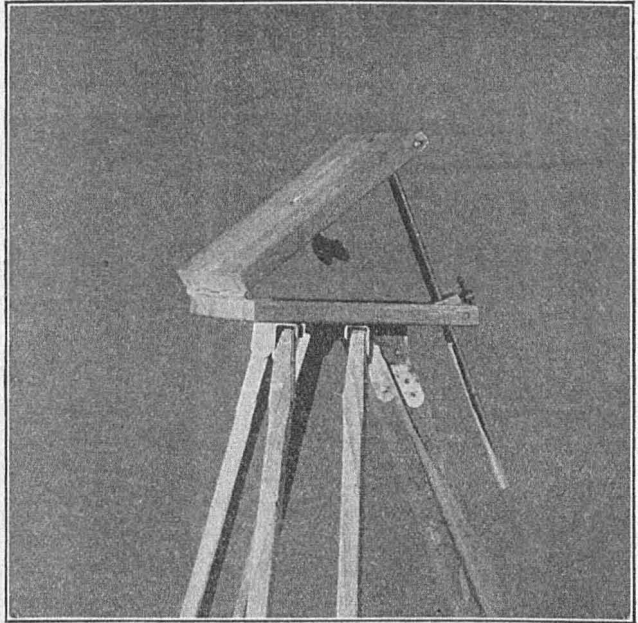

FIG. 2.—Tripod top by means of which the camera may be inclined at any angle. For explanation see the text.

camera by using a tripod with legs some 10 feet long, such as dealers sell for use in making pictures of large groups. In such tripods one leg forms a ladder by which the camera may be reached.

The tripod top should consist of two rectangular wooden pieces, as shown in figure 2 and in section in figure 1. To the lower piece, which has a large circular opening at its center, the legs are attached. The camera is fastened by the tripod screw to the upper piece in such a way that one of the legs projects directly backward instead of directly forward, as is usual. The two pieces are hinged together at one edge, so that they may lie parallel to one another or may be separated like the covers of a book until the upper piece forms an angle of  $90^\circ$  with the lower. A rod is pivoted by one end to the upper piece at the middle of its free edge, so that it swings freely in the vertical plane. This rod passes through a perforated metal block pivoted by one end at the middle of the free edge of the lower piece so as to swing freely



in a plane vertical to that piece. When the two pieces are separated by moving the upper one on the hinge which connects them the rod slips through the opening in the block and may be firmly clamped at any point in its length by means of a set screw. Thus the upper piece may be held firmly at any angle to the lower piece from  $0^\circ$  to  $90^\circ$ , and the camera may be pointed at the water at any desired angle. The position in which the legs of the tripod are attached permits the camera to be pointed directly downward in the space between the two front legs, whereas if the legs were attached in the usual manner with one leg in front it would be impossible to bring the camera into the vertical position. Tripods of this type are to be found in the market or may be made from an ordinary tripod by any mechanic.

When the operator has placed his camera and roughly adjusted it, he should set up a screen to cut off the light reflected from the surface of the water into the camera. Any piece of dark fabric, a blanket, shawl, or for small objects even a coat, may be used. It may be supported by hand or tied to poles stuck in the bottom. The writer carries into the field a screen made by sewing together pieces of black calico to form a sheet either 6 or 9 feet square. To three of the edges of this, at intervals of about a foot, are sewn pieces of tape each about a foot long and attached at its middle so as to leave 6 inches projecting on each side. One piece of tape should be attached to each corner of the screen. Two poles are cut of sufficient length to project 6 to 10 feet above the water when firmly set in the bottom. The poles are sharpened at one end, and beginning at the unsharpened end the square of calico is tied to them by the opposite edges by means of the tapes. The third side to which tapes are attached is the upper, between the unsharpened ends of the poles. The poles are now thrust into the bottom on that side of the camera opposite the object to be photographed and so that they slant toward the camera. The screen (*s s'*, fig. 1) is thus stretched upward from the surface of the water in a slanting position, so that its upper edge is nearer the camera than its lower. If the two poles are pulled together by the weight of the cloth or the action of the wind so that the screen sags, a third pole tied between their upper ends will keep them apart, while the tapes on the upper edge of the screen will serve to attach it to the cross-pole.

If the operator now returns to the camera he will see the screen mirrored in the surface of the water. The object to be photographed should fall within the limits of this mirrored image as seen from the camera.<sup>a</sup> If it does not, the screen or the camera must be shifted until it does. The operator will see also the shadow of the screen. This should *not* fall on the object to be photographed. The screen should, if possible, be adjusted by slanting it or by moving one of the poles so that the sun strikes it nearly edgewise, but yet does not strike that face of it which is toward the camera. If this adjustment is properly made the shadow of the screen is a very narrow band, which lies beneath the screen and a little nearer the camera than its lower edge. The full sunlight then falls on the object while the rays from

---

<sup>a</sup> Saville-Kent (1893) apparently utilized this principle when photographing with a vertical camera on the Australian barrier reefs, but Rudaux (1908) stated the principle explicitly as applied in photographing in natural waters with a vertical camera objects within the reflected image of the tripod top. Neither recognized the broad application of the principle here described.

distant objects which would otherwise be reflected into the camera from the surface of the water are cut off. If the sunlight is permitted to fall on that face of the screen which is toward the camera, it is reflected from the screen to the surface of the water and thence into the camera. A picture taken under these conditions may show, besides the object under the water, also the screen itself, although this image of the screen is usually so faint that it does not interfere with the use of the picture for scientific purposes.

When the screen has been properly set the operator has merely to adjust the camera and make the exposure in the customary way. If the subjects are fish they will usually have been frightened away, but if the fish are engaged in nest building or in some other occupation that attracts them to a particular spot, they will, in most cases, return after a time varying from five minutes to an hour. The operator has merely to remain quiet until this happens. The photographer may focus his camera on the spot to which the fish is likely to return and then withdraw and operate the camera from a distance by pulling a string or pressing a bulb when the fish returns. The method is of most use in securing photographs of the nests and habitats of fish in shallow water, yet the writer has succeeded by means of it in making some satisfactory photographs of fish on the nest.

The result of using the screen is shown in figure 1 of plate III, which is a photograph of the nest of a small-mouthed black bass. The screen in this case was stretched on a frame and was held by hand. Within the limits of the reflection of the screen in the water's surface the bottom may be seen clearly. At the center are the larger stones which form the bottom of the nest, and these show sharply the details of their markings. Outside the limits of the reflection of the screen the bottom is not clearly visible; its image has been obscured on the sensitive plate by the bright light reflected from the surface of the water. The sun struck the back of the screen from the left, as is shown by the shadow which lies close to the screen. Within the limits of this shadow the plate was underexposed and details of the bottom are not visible. With a longer exposure as good a negative could have been made of what lay in the shadow.

If the surface of the water is not smooth it may be made so by a water glass, which may be constructed as follows (fig. 1, pl. IV): A square frame is made of heavy galvanized iron, and measures  $3\frac{1}{2}$  inches deep and 12 inches on each side within. One of its edges (the top) is turned outward three-fourths of an inch and then downward one-half inch to form a lip. This stiffens the frame and tends to prevent water from slopping into it. The lower edge of the frame is turned outward about half an inch to form a flat surface, against which the glass, 13 inches square, is bedded in aquarium cement. After the glass is in position four trough-shaped pieces are soldered to the sides of the frame and to one another in the manner shown in the figure. The free edges of these pieces project inward beneath the lower surface of the glass and support it. Before the pieces are soldered into place cement is placed between them and the lower face of the glass. The whole border of the glass is thus bedded in cement on both surfaces and at the edge. To protect the glass when not in use a flat cover is provided, which fits against its lower face. Such a water glass may

be floated over the object to be photographed and a screen set up independently of it, or the screen may be attached to the glass itself. For the latter purpose a piece of half-inch band iron may be bent to form the three sides of a rectangle, 8 by 12 inches, and this may be riveted as a bail (fig. 1, pl. iv) to the inside of the frame, about 8 inches from one side. The bail should turn on the rivets so that it may be depressed into the frame when not in use. A screen may be formed by raising the bail and tying a piece of black cloth from it to the opposite side of the frame. In shallow, running water it is desirable to support the water glass from the bottom in order that it may not sink so much as to displace or distort the object to be photographed. It may be supported on four iron rods which run through metal sleeves soldered to the four corners of the frame. The rods may be fixed in any position in the sleeves by means of set screws, and may project upward far enough to support the upper edge of the screen. A water glass arranged in this way is shown in figure 2, plate iv, where it is being used for observation, but with the same glass photographs were obtained of lamprey eels in the act of spawning. Such a photograph is reproduced in figure 2, plate iii, where the rough surface of the running water made the use of the water glass imperative. The white bands across the picture are the edges of the frame of the water glass. Outside this frame at the right, where the water is rough, little is visible. The screen was almost as necessary as the water glass.

The writer has used water glasses of this type varying in size from 1 to 3 feet square. Those of 1 foot square are of use chiefly for observation, and even for this purpose the screen is a valuable addition. Those of 3 feet square are so unwieldy that a vehicle of some sort is needed to carry them. The size most suitable for field photography is 2 feet square, since this may be transported by hand.

The method described in this section is suited only to shallow water, where the camera may be supported from a firm substratum. In deeper water the unsteadiness of the boat would interfere with the manipulation of a water glass or a screen. It might be possible, however, to construct a boat of which the water glass and the screen should form constituent parts. The method described permits only of views at angles of from about  $48^{\circ}$  to  $90^{\circ}$  to the water's surface. Since it is not practicable to place the camera far above the water at these angles or to use screens of very large size, the pictures that may be taken are of near objects and the field covered by them is of limited extent. If a water glass is used, the camera must be near it and the field is limited by its frame. The method is, however, the only one known to the writer for certain kinds of work. Often, as in the case of the bass nest shown in figure 3, the objects to be photographed are in water so shallow that the camera must be placed above its surface; there is not room for it beneath. Often, though the object may be in deeper water, it is so surrounded by vegetation that it can not be seen from a little distance except from above. It must then be photographed from above. Where the water is both shallow and disturbed, as in small streams, the use of a water glass is essential. There are therefore many objects about the borders of lakes and in streams to which this method may be applied when no other known method is available. On the other hand, wherever it is possible to use a submerged camera, results may be obtained with greater ease and certainty in the manner shown in the section which follows.

## PREVIOUS ATTEMPTS TO PHOTOGRAPH SUBMERGED OBJECTS BY MEANS OF A SUBMERGED CAMERA.

Photography by means of a submerged camera was first attempted by Dr. L. Boutan, of Paris, at the seaside laboratory of Roscoff, in 1893. His work was continued through the seasons of 1895, 1896, 1897, and 1898, and the results have been published in four communications (Boutan, 1893, 1898, 1898a, 1900). Boutan's apparatus was used wholly in the sea, and he has given to his method the title "la photographie sous-marine." I shall use instead the broader term subaquatic photography, as indicating the wider application of the method to both fresh and salt water.

Boutan made use of three forms of apparatus, which may be designated as his first (1893), second (1896), and third (1898) apparatus. Each of these will be briefly considered.

He was led to take up subaquatic photography by his study of the development of the mollusk *Haliotis*. Finding it impossible to rear the larvæ of this form in aquaria and failing to collect them in their natural environment by the usual methods, he decided to search for them by descending in a diver's suit. He was struck by the beauty and interest of the submarine landscape and of its inhabitants. He found it impossible to bring his experiences vividly before others by mere verbal description and equally impossible, while inclosed in the cumbersome garments of the diver, to make drawings, or even sketches, of what he saw. He was thus led to try photography. He appears to have made no attempt to operate with a camera placed above the water, for, as he says, "when the surface of the liquid is absolutely quiet the rays of light coming from submerged objects enter the objective placed in air at the same time with the rays reflected by this mirroring surface and that suffices to destroy all clearness in the images." He objected to this method for the further reason that it could result in giving only a plan or bird's-eye view similar to that which is obtained when landscapes are photographed from the elevated car of a balloon. He therefore decided to construct an apparatus that could be used under water. It seemed to him possible to proceed on either one of two principles: (1) "To have made an objective that could be immersed directly in water." (2) "To have built a tight box in the interior of which the ordinary objective could be placed protected from salt water." In his first and third forms of apparatus Boutan made use of the second principle. In his second attempt he made use, without success, of an objective immersed in water.

## BOUTAN'S FIRST APPARATUS (1893).

In this apparatus Boutan made use of a detective camera of fixed focus, an instrument intended to make instantaneous pictures at all distances beyond 3 or 4 meters without focusing. This camera was of the box form usual in detective cameras. It was provided at the front with an opening for the lens and above this with two openings for the finder. At the front there was on one side a lever or button which controlled the shutter and at the back a rod by the movement of which it was possible, without opening the box, to change the plates, a number of which were carried in the magazine of the camera.

This camera was inclosed in a copper box (fig. 3). The top of the box was open and was stiffened by a projecting rim against which a cover could be clamped by means of eight metal screw-clamps. The joint between the rim of the box and the cover was made water-tight by means of a heavy rubber gasket let into rectangular grooves in both the rim and the cover. The box was intended to be used at considerable depths. The pressure of the water on its outside would at 10 meters depth be one atmosphere plus the pressure exerted by a column of water 10 meters high, while the pressure on the inside of the box would be what it was when the box was closed at the surface, one atmosphere. Under these circumstances there was serious danger that the excess pressure on the outside of the box would force the water through between the rim and the cover in spite of the most careful construction of the joint between the

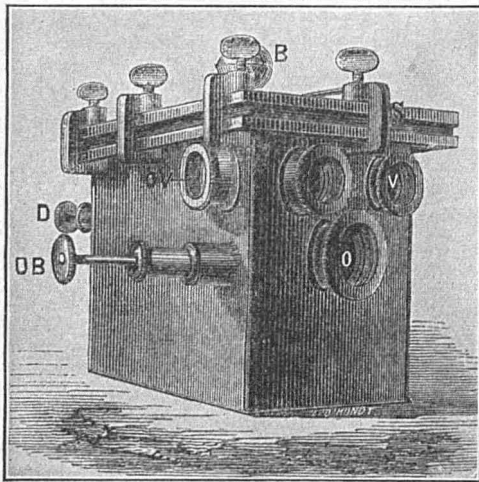

FIG. 3.—Boutan's first apparatus. Box used in 1893 for inclosing a detective camera to be used under water. B, rubber balloon filled with air; D, handle at the back for operating the magazine plate holder; O, opening corresponding to the lens; OB, handle at the side controlling the shutter; V, front finder; OV, lateral finder. (Copy of fig. 1 in Boutan, 1893.)

two. To overcome this difficulty, the cover of the box was provided at its center with an opening which extended upward into a metal tube, and to this tube there was attached an air-filled rubber bag of about 3 liters capacity. When the box was submerged the pressure of the water on the bag was communicated to the air within, so that the pressure on the inner surface of the box was exactly equal at all depths to that on its outer surface. Thus there was no excess pressure on the outer surface of the box to force the water inward against a less pressure within.

The front of the box was provided with three circular openings closed by plates of glass with parallel surfaces. The one at the center was opposite the lens; the two above it were for the finder. A similar opening on one side was also closed by a glass plate and served for the finder. On the same side was a rod which terminated at its outer end in a milled head. Its inner end extended, through a stuffing box which was water-tight, to the interior of the box. By pulling the rod in and out the shutter could be operated. A similar rod at the back of the box could be slid in and out and served to change the plates. When in use the camera was supported on a heavy tripod of iron.

The apparatus was used either while the operator remained in shallow water with his head and shoulders above the surface or when he had descended to the bottom in a diver's suit. When working in shallow water, he put on the diver's suit in order to be protected from the water, but omitted the casque covering the head and the heavy weight ordinarily attached to the back and front of the suit. Thus arrayed, he placed the tripod in position and attached the camera to it. In

order to bring the camera to bear on the object to be photographed, it was then necessary to provide a way to determine when the image of the object appeared in the desired position in the finder. This was accomplished by using a metal tube open at both ends, one end of the tube being placed over the ground glass of the finder and the other, which extended above the water, being applied to the eye. The tube excluded the light from the space between the eye of the observer and the finder, while at the same time the water within it was protected from agitation. By this means it was possible to see clearly the image on the ground glass of the finder. It was necessary merely to manipulate the handle controlling the shutter in order to begin and end the exposure. The plate could then be changed by manipulating the rod at the back of the box and another exposure made at once without taking the camera from the water. Where it was possible to operate near shore, it was unnecessary for the operator to put on the diver's suit or to enter the water. He could set the camera in place from the shore and adjust it or make the exposure while lying upon the bank. Boutan, indeed, made satisfactory photographs of fixed animals in aquaria by immersing this apparatus in an indoor aquarium and operating it by means of a string. By using a very small diaphragm he was able to get clear images of objects at a distance of 15 centimeters from the lens, but this required an exposure of three minutes. He obtained photographs of fish and other mobile forms in the same manner by inclosing the animal to be photographed in a glass globe, which was then immersed in the aquarium at a suitable distance from the lens. The globe served to restrict the movements of the animal. When working in shallow water, he found that the algæ which appear everywhere in the submarine landscape were in constant motion whenever there was any movement of the water. It was therefore necessary to restrict operations to those days on which it was perfectly calm.

In order to obtain photographs at depths at which it was impossible to wade Boutan made use of the diver's outfit. He describes the outfit in detail and the method of using it in a very interesting section of his paper of 1898. The method of procedure was briefly as follows: The boat containing the apparatus to be used (diver's suit, air pumps, and photographic apparatus) was first firmly anchored at the spot selected and held in place by means of cables stretched to the rocks on shore. The photographer then put on the diver's suit and descended to the point selected as the center of operations. He first signaled to an assistant to let down the photographic apparatus, which consisted of the tripod, the box containing the camera, and a weight intended to steady the apparatus. He then sought out the view to be taken and set up the apparatus at his leisure. This accomplished, he opened the shutter of the camera and signaled to the assistant that the exposure was begun. Since it was impossible to use a watch while under water it was necessary that the assistant in the boat above should time the exposure. At the expiration of the time agreed upon the assistant signaled and the photographer closed the shutter. When the weather was good and the sun shining an exposure of ten minutes was necessary with a small diaphragm at a depth of 5 meters. Boutan estimated that at a depth of 10 meters this exposure would need to be more than doubled.

## BOUTAN'S SECOND APPARATUS (1896).

This apparatus (fig. 4) consisted of a metal camera, not inclosed in a box, but intended to be immersed directly in sea water. The sea water could enter and fill the interior of the camera so that it bathed both the front and back faces of the lens as well as the plates. The latter were contained in a holder which could be attached to the camera after it was submerged. Thus the plates could be changed under water without any risk of fogging them. Sea water was found to have little effect on the plates unless its action was prolonged, and this effect could be wholly prevented by using plates that had been varnished.

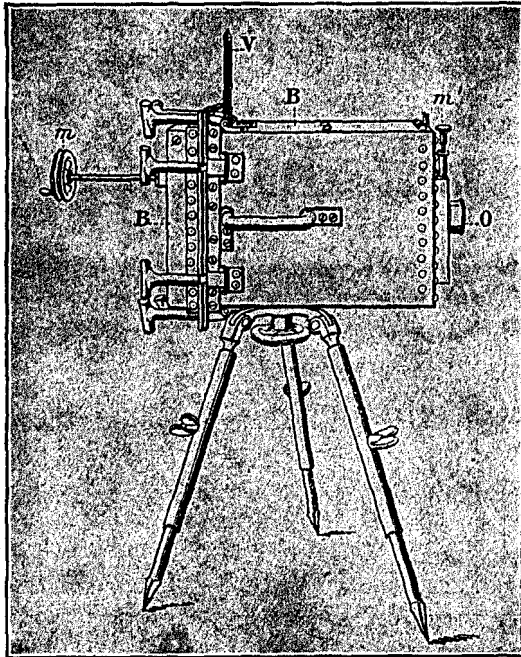

FIG. 4.—Boutan's second apparatus. B, camera box into which the water could penetrate freely; *m*, handle controlling the plate holder; *m'*, handle controlling the shutter; O, objective; V, sight. (Copy of fig. 2 in Boutan, 1898.)

designed for instantaneous work, consisted of a heavy metal box, shown at the center in figure 5. To it are attached four adjustable legs. The box, which is water tight, contains the objective and the plates. It is itself the camera and does not therefore contain within it a camera, to be lifted out and put back. The lens is a Darlot symmetrical-anastigmatic of excellent quality. At the front is an opening (O) closed by a plate of glass, through which the light enters the lens. There are no finders and consequently no openings closed by glass plates, with the exception of that for the lens. At the top, in front, is a handle by means of which the shutter may be operated. About the center of the box is clamped a band-iron frame with a ring at the top by means of which the box may be attached to a rope for lifting it in and out of the boat. At the back is a cover which may be fastened by means

The lens used with this apparatus was one intended for use in air, and it was found that good results could not be obtained with it when immersed in water. The success of such an apparatus as this must depend on having a lens especially ground for use under water. No lens of this sort existed and to have one calculated and made would have been expensive. For this reason and for others which he mentions Boutan abandoned this apparatus after trying it for a single season. He says, "The principle is certainly good, and, in spite of the failure that I have made in the application of it, the future of submarine photographic apparatus may lie there."

## BOUTAN'S THIRD APPARATUS (1898).

As a result of the failure of his second, Boutan adopted a third apparatus, which was in principle a return to the first. This third apparatus,

of screws against a rubber packing on the end of the box, so that the joint between cover and box is made water tight. The rubber bag used in the first apparatus seems to have been found unnecessary and is at any rate omitted. At the back of the cover there projects a handle (M) by the manipulation of which the plates may be changed. On the top at V is a sight by means of which the camera may be directed at the desired object. Within the box at the back is a magazine plate holder for six plates. This is represented at the left at CH in figure 9. It is so arranged that when a plate has been exposed it may be made to fall forward by turning the handle shown at M in the central figure. A second plate is at the same time pushed into place by springs. When this has been exposed a second turn of the handle allows the plate to fall and a third plate comes into place. Six plates may thus be exposed without opening the box. On each side of the plate holder are two cleats (*gl*). These glide upon two rails on the inside of the box, one on either side, so that the plate holder may be moved back and forth on the rails away from the lens or toward it. By means of a set screw the plate holder may be firmly clamped at any point on the rail. The camera is focused by means of this movement of the plate holder. To prevent reflection of light from the lower side of the surface film of the water into the camera there is provided a semicylindrical

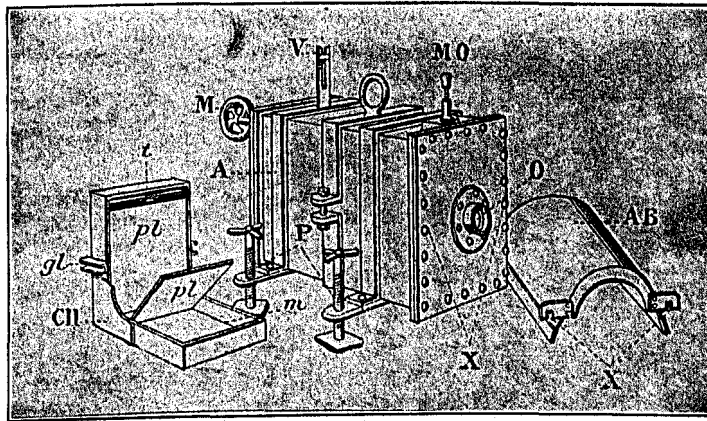

FIG. 5.—Boutan's third apparatus (1898). A, metal camera box; M, handle controlling the changing of plates; MO, handle controlling the shutter; O, opening for the lens; P, feet for supporting the apparatus; V, sight; X, points of attachment of the hood AB; CH, magazine holder for six plates; *gl*, cleats by means of which the holder glides on a rail inside the box; *pl*, plates; *t*, pin which holds the front plate in place. (Copy of fig. 3 in Boutan, 1898.)

shade shown at AB on the right in figure 5. It may be attached to the front of the box above the lens by the arrangement shown at X.

It is not possible to focus after the box has been closed in order to immerse it. Consequently one of the rails upon which the plate holder moves must be provided with a scale. The divisions on this scale correspond to different distances between the lens and the object to be photographed. When the plate holder is set at a certain division of the scale the camera is in focus for objects at a distance of 4 meters; when set at another division for objects at 2 meters. It is therefore necessary to determine before the camera box is closed at what distance the object is to be photographed and to focus by setting the plate holder at the corresponding division on the scale. While the box is immersed this focus cannot be changed. The divisions to be marked on this scale were obtained by focusing on submerged objects while the front of the camera was also submerged. This necessitated the use of special devices, which need not be described here.



This apparatus, which used plates 18 by 24 cm. (approximately 7 by 9 inches), was so heavy that it required three men to handle it easily in air. On shipboard it was handled by a tackle and swinging boom. It was first lowered into the hold, which could be closed light tight. There the plates were put into the plate holder and this was set at the division of the scale previously decided upon. The box was then closed water-tight by screwing the cover in place. To remove the moisture from the air within the box and thus prevent its condensation on the lens and other parts within, a wide-mouthed bottle containing quick lime was kept in the box during the intervals when it was not immersed. The apparatus was then hoisted from the hold, swung outboard and lowered to the operator, who had meantime descended in the diving suit and selected the point at which the photograph should be made. It was not very difficult for the operator to handle the apparatus when it was sub-

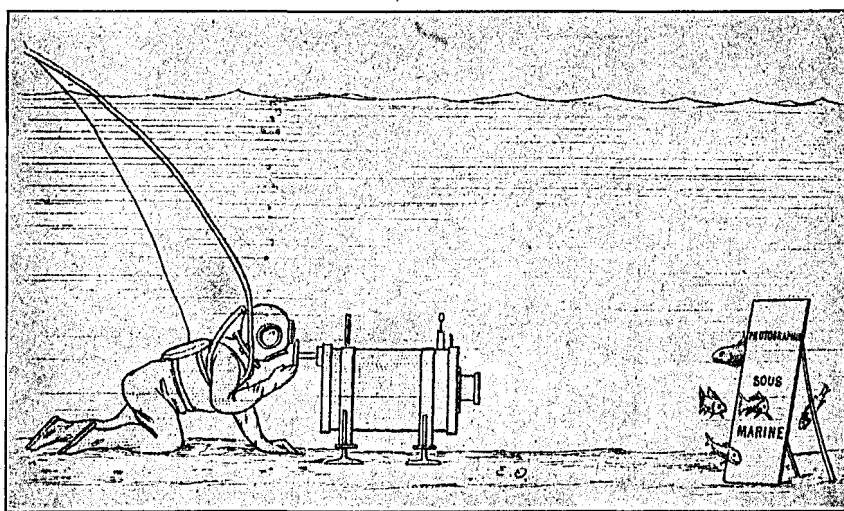

FIG. 6.—Showing Boutan's method of obtaining instantaneous photographs of fish with his third apparatus. (Copy of fig. 7 in Boutan, 1898.)

merged, since it was then buoyed up by the water. It was found easier to move it about when it was suspended by means of a rope to a cask floating at the surface.

The method of using the camera for photographing fish is shown in figure 6. The camera, previously set for objects at a distance of 2.5 meters, was placed on a sand bottom at a depth of 3 meters. Here it was either allowed to rest on the bottom on the legs attached to it or was supported above the bottom on a heavy, four-legged iron frame. The camera rested on a platform within this frame and the platform might be so adjusted that the camera could be set at various heights and pointed at various angles up or down. At a distance of 2.8 meters from it was set up obliquely a large white screen of painted canvas stretched on an iron frame provided with feet. This screen served as a background for the fish. To attract the fish the operator then placed in front of the screen at a distance of about two meters a bait of crushed sea-urchins and annelids. He then pointed the camera by means of the sight on top and waited until the fish, attracted by the bait, were in such a position as to be in focus, when by means of the handle at the

front he made the exposure. The plate was then changed and several exposures made in succession. The screen was useful as affording a contrasting background but was not considered necessary, since very clear negatives were obtained of fish viewed against the sand or ooze bottom. One of the photographs of fish taken against a screen background is reproduced by heliogravure in Boutan's memoir of 1898. Though the fish were in motion, the outlines of most of them appear sharp against the screen, evidence that the picture was instantaneous. The fish are, however, unfortunately almost wholly lacking in detail. The time of the exposure is not stated, but it was clearly too short to give detail in the shadows.

In figure 7 is shown a method adopted by Boutan for operating the camera from a boat by means of a string. In this case the apparatus was first placed in

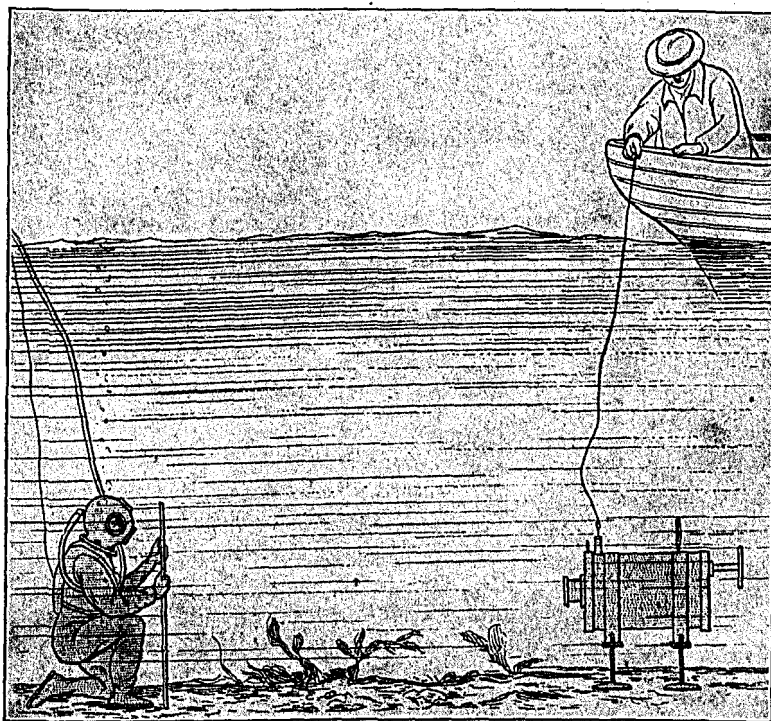

FIG. 7.—Showing Boutan's method of operating his third apparatus from a boat by means of a string. A diver is being photographed. (Copy of fig. 8 in Boutan, 1898.)

position by the diver, who then withdrew to the distance for which the camera was focused. The operator, who could observe the procedure from the boat, then pulled the string. The resulting picture, which is reproduced in Boutan (1898), is excellent. Subsequently exposures were made from the surface by using a shutter controlled by an electro-magnet.

#### BOUTAN'S METHODS OF ARTIFICIAL ILLUMINATION.

Besides his camera, Boutan (1893) describes an apparatus for using a magnesium flash-light beneath the surface of the water. He succeeded subsequently in taking good instantaneous pictures at a depth of 3 meters without artificial

light, and estimated that in good weather it would be possible to do this at depths of 7 or 8 meters.

Although his flash-light apparatus proved to be unnecessary in shallow water and was subsequently abandoned as cumbersome and dangerous, it merits a word of description. His figure of it is reproduced in figure 8. In its final form it consisted of a cask of about 200 liters capacity closed at both ends, but with the lower end perforated by holes to permit the entrance of sea water. A bell jar of 5 or 6 liters capacity is held tightly against the upper end of the cask by means of the adjustable frame shown in the figure. The cavity of the jar communicates freely through many openings with that of the cask, and both are filled with air.

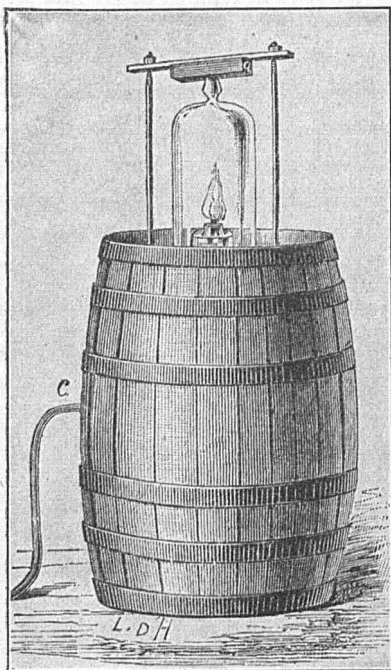

FIG. 8.—Boutan's apparatus for using a magnesium flash-light under water. The reservoir for the magnesium powder, the rubber bulb, and the weights used to steady the apparatus are not shown in the figure. (Copy of fig. 3 in Boutan, 1893.)

Within the bell jar is an alcohol lamp, and at the side of this is a metal reservoir (not shown in the figure), covered with asbestos and filled with magnesium powder. One end of a metal tube opens opposite the middle of the flame of the alcohol lamp (shown lighted in the figure) and communicates freely with the reservoir above. The other end of the tube extends into the cask, and is there connected to a rubber tube which extends through the side of the cask (at *C* in fig. 8) and ends in a large rubber bulb. To use the apparatus, the reservoir is filled with magnesium powder and the alcohol lamp lighted, then the bell jar is fastened in place and the cask, heavily weighted at the bottom, is lowered into the water and set wherever needed. The air in the bell jar and cask is enough to keep the alcohol lamp burning for some time. To produce the flash it is merely necessary to press the bulb, when the magnesium powder, which has fallen from the reservoir into the tube, is blown against the flame from the end of the tube and ignited. This operation may be repeated as long as the lamp remains burning and the reservoir contains magnesium. It is of course necessary to operate the shutter of the camera simultaneously with the flash.

Boutan (1900) describes and illustrates another illuminating apparatus which consists of two powerful arc lamps inclosed in water-tight jackets of heavy metal, designed to withstand the pressure of the water at a depth of 50 meters or more. Each jacket was pierced by an opening into which was fitted a condensing lens, by which the emerging light was concentrated upon the object to be photographed. The two lamps were rigidly attached to the camera support and were supplied, through a cable, with current from storage batteries on board the boat. The same cable carried also an insulated wire through which an electro-magnet actuating the shutter of the camera could be controlled. The camera with lamps attached was lowered into the water. When the camera was on the bottom the lamp circuit was closed by means of a switch on board the boat, and when it was

seen that the lamps were working, the shutter was operated from the boat. In this way good photographs of gorgonias were obtained at night at a depth of 6 meters, with an exposure of five seconds. It is not necessary that the diver should descend to place the lamp in position. The same apparatus was worked successfully at a depth of 50 meters, in this case the apparatus not being allowed to rest on the bottom, but being held suspended from a cable at some distance from the bottom. The object photographed was a canvas screen rigidly attached by rods to the camera support at such a distance from the lens as to be sharply focused. When the apparatus was brought to the surface it was found that one of the lamps had failed to withstand the pressure so that its jacket was filled with water. With lamps and camera constructed to withstand the pressure at great depths, Boutan believes that an apparatus of this sort may be used at depths to which light does not penetrate. The apparatus may of course be used by a diver at depths of 40 meters or less, and the camera may then be directed at any desired object; but at greater depths a diver can not work, and the apparatus must then of course be let down at random, to photograph only what chances to be in the range of its lens.

Boutan's work has the great merit of having demonstrated that it is possible at a depth of 3 meters to obtain good instantaneous pictures by the light of the sun and without the use of artificial light. He showed further that his apparatus with electric illumination could be immersed and operated from outside the water at depths as great as 50 meters. For work at great depths or by artificial light no better apparatus is known. The faults of it, for work in shallow water or at any depth to which a diver can descend, are (1) its great bulk and weight, and (2) the fact that it can not be focused under water. It can not be carried about freely, and for use it must be set on the bottom at a known distance from the object to be photographed and must then be sighted at that object. It is unfortunate that for work in shallow water Boutan did not make use of the principle of the twin camera or the reflecting camera, for by using either of these devices he could have made an apparatus that was portable and that could have been focused under water. He could thus have carried his camera about as one carries detective cameras and could have photographed submarine objects either while wading with his head above water or in moderate depths while on the bottom in a diver's suit.

#### BRISTOL'S SUBAQUATIC CAMERA.

That such a method is feasible and that it may yield better results than those obtained by Boutan was suspected as early as 1898 by Prof. C. L. Bristol, who immediately began work on a submarine photographic apparatus. Nothing has as yet been published concerning this apparatus, and the details of its construction are quite unknown to me. Professor Bristol kindly permits me, however, to make the following quotation from a letter to me on the subject: "From the first I have used a water-tight camera capable of submersion in from 10 to 15 fathoms, mounted on a tripod with a universal motion, arranged so as to show the picture on the ground glass as well as to focus the lens and make the exposure. Moreover, a magazine attachment permits me to carry down several plates and to change them after each exposure while under water. After several seasons' efforts the apparatus is now very efficient and has produced excellent results. I am not yet ready to publish a detailed account."

## A NEW SUBAQUATIC APPARATUS.

When a camera for subaquatic use is made after the ordinary type the box must be securely closed before submerging it in order to protect the lens and the plates from the action of the water. While the camera is under water it is not possible to remove the plates or plate holder in order to substitute a ground glass for them. It is therefore impossible to focus, and the camera must be adjusted to the desired focus before immersing it. This was the method adopted by Boutan in his third apparatus. It would be possible to construct a camera that might be focused under water by means of a focusing scale such as is provided in those hand cameras arranged to be focused without the use of a ground glass, the operator estimating the distance of the object and then setting the camera for a corresponding

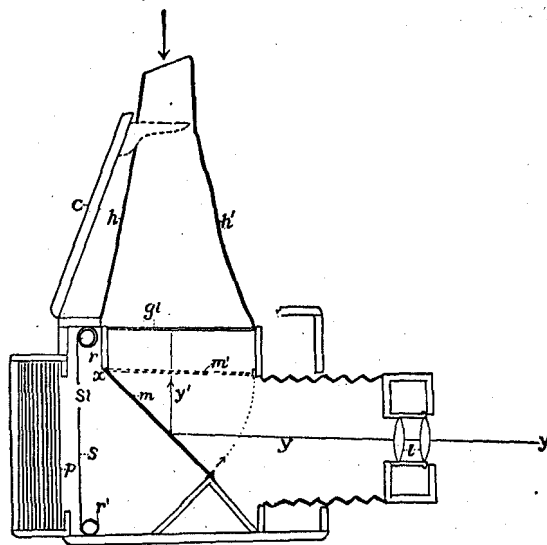

FIG. 9.—A reflecting camera shown in section, with magazine plate holder attached. *gl*, ground glass; *h h'*, hood; *l*, lens; *m*, mirror in position during focusing; *m'*, mirror, showing position during exposure; *p*, sensitive plate; *r* and *r'*, rollers of focal plane shutter; *s*, the shutter; *sl*, slot in shutter; *x*, hinge on which mirror turns; *y y'*, ray of light traversing the lens and reflected from the mirror to the ground glass.

The other camera carries the ground glass. The same focusing mechanism operates both cameras, so that when a sharp image is formed on the ground glass of the one an identical image strikes the sensitive plate in the other when the shutter is operated. One of the cameras serves merely as a focusing finder of full size. A camera of this type properly constructed of metal could undoubtedly be used successfully under water, though it has the disadvantage of being unnecessarily cumbersome and expensive.

## THE CAMERA.

All of the advantages of the twin camera are to be had by using a reflecting camera, which is at the same time both lighter and less expensive. The principle of the reflecting camera is shown in figure 9, which represents diagrammatically

division on the focusing scale. This method is of value for more distant objects and with rather slow lenses of great focal depth. When very rapid lenses are focused on near objects only those objects are in focus that lie nearly in one plane. Thus a very accurate adjustment of the camera is necessary in order to bring any near object into sharp focus, and this is not possible when the distance of the object must be estimated and the focusing accomplished by means of a scale. In subaquatic photography the objects to be photographed are all near and if instantaneous work is to be done the lens must be very rapid. It is therefore important to be able to focus accurately on the ground glass under water, and this might be accomplished by using two identical cameras (twin camera) united so as to form one instrument. One of these contains the plates and has a lens provided with a shutter.

such a camera in longitudinal section. The ground glass (*gl*) is placed, not at the back of the camera, as is usual, but in the top. The operator, holding the camera in front of him, looks in the direction indicated by the upper arrow, at the ground glass through the hood (*h h'*), which takes the place of a focusing cloth. The interior of the camera contains a mirror (*m*), which extends from beneath the back edge of the ground glass downward and forward at an angle of  $45^\circ$ . The mirror is hinged at *x* to the top of the camera. When it is in the position shown at *m* in the figure the space between the back of the mirror and the back of the camera is quite dark. Light entering through the lens is reflected by the mirror and strikes the ground glass, as shown by the line *y y y'*. The image as seen on the ground glass by the operator looking down through the hood is, on account of the action of the mirror, an erect image, not an inverted image such as one sees on the ground glass in the back of an ordinary camera. It is also an image of the full size permitted by the plate and the lens, not a reduced image such as one sees in a finder. The shutter (*s*) is a focal plane shutter situated at the back of the camera just in front of the plate (*p*). Such a shutter is essentially a roller curtain of black cloth with a slot (*sl*) across it at one point. The width of the slot may be regulated. The shutter is wound upon an upper roller (*r*) until the slot is upon the roller. The exposure is made by causing the curtain to unwind from the upper roller (*r*) and wind upon the lower roller (*r'*) so that the slot passes very rapidly across the face of the plate. The length of the exposure depends on the width of the slot and the rate at which it moves. The rate may be varied by changing the tension of the spring which actuates the lower roller. The operator holds the camera in front of him with both hands while he looks down at the ground glass through the opening in the hood. With one hand he focuses. When the object appears in sharp focus and in the desired position on the ground glass, he presses a button with the other hand. This causes the mirror to swing on its hinge to the position shown by the dotted outline *m'* beneath the ground glass. In this position the mirror excludes light which might otherwise enter the camera through the ground glass. At the same time the change in position of the mirror permits the light, which was before reflected to the ground glass, to fall upon the plate. The adjustment is such that an image which is in sharp focus on the ground glass will be in sharp focus on the plate when the mirror changes position. The image does not actually strike the plate so long as the shutter is wound upon either roller. Before the instrument is to be used the shutter is wound on the upper roller. When the mirror in swinging upward reaches the position *m'* the shutter is released from the upper roller and taken up on the lower roller. As the slot passes across the plate from above downward, the image falls through the slot onto the plate in successive strips corresponding to the width of the slot.

The advantages of this form of camera are the following:

1. The operator sees a full sized, erect image on the ground glass, while at the same time the sensitive plate is in position for exposure.
2. He is able to focus and to regulate the position of the image on the ground glass up to the instant of exposure.
3. Much more rapid exposures may be made with the focal plane shutter than with the ordinary diaphragm shutter. The diaphragm shutter occupies a considerable

time in opening and closing, and during the period of operation prevents the light from passing through the full opening of the lens. If the time from the instant a diaphragm shutter begins to open until it is closed again is one one-hundredth of a second, then a considerable part of this time (usually about 40 per cent) is occupied by the opening and closing. The shutter is then wide open and the lens working at its full opening during only a fraction of the one one-hundredth of a second. With the focal plane shutter, on the other hand, if the slot requires a hundredth of a second to pass a given point on the plate, the lens may be wide open during the whole of that time, so that all the light that the lens is capable of passing reaches the plate during the whole of the exposure. For this reason much more rapid exposures may be made with the focal plane shutter than with the diaphragm shutter.

Various forms of reflecting camera are in the market, and it is possible to obtain a magazine plate holder, which carries 12 plates, arranged to be changed without removing the plate holder from the camera or inserting the dark slide. Such a camera, with the magazine holder, is shown diagrammatically in section in figure 9. It is surprising that Boutan, when he was seeking some means of focusing his camera under water, did not make use of the idea of the reflecting camera; for by merely inclosing such a camera in a water-tight metal box and arranging it to be operated from outside the box, he would have had a portable apparatus capable of being manipulated under water almost as readily as on land. A reflecting camera was manufactured in New York as early as 1886, and was advertised at that time and represented by a Paris agent.

#### THE WATER-TIGHT BOX.

A 5 by 7 camera of the type just described, with a magazine holder for 12 plates, was used by the writer to obtain submarine photographs at Tortugas, Fla., during the season of 1907. The box (fig. 2, pl. v) to contain the camera was made of galvanized iron by a tinsmith. It measures about 17 inches long, 9 inches high, and 10 inches wide. The front is closed by a square of plate glass cemented with aquarium cement into a groove formed in the metal. At the top is an opening large enough to permit the camera to pass, bottom first, into the box. To the outside of the rim of this opening is soldered half-inch square brass tubing jointed at the corners into a rectangular frame. The upper surface of this frame is made as smooth and as nearly plane as possible. Eight brass screw-bolts are soldered into holes drilled through this frame. They occupy the positions shown in the figure and the threaded end of each projects about three-quarters of an inch above the frame. The cover consists of a flat sheet of metal bordered by a frame of brass identical with that on the box. This frame is perforated by eight openings through which the screw-bolts pass. From the cover there arises an irregular truncated pyramid of galvanized iron, which incloses the hood of the camera. At the top this is closed by a piece of plate glass. By means of wing nuts on the screw-bolts the cover may be tightly clamped to the box, against an intervening gasket of rubber.

On the right hand side of the box is a large milled head of brass from which a brass stem passes to the interior through a stuffing box, which prevents the entrance of the water along the stem. At its inner end the stem terminates in a

two-pronged fork. The stem may be pulled in and out in the stuffing box through a distance of about three-quarters of an inch. When the stem is pushed in, the prongs of the fork engage in two holes drilled in the focusing head of the camera. By turning the milled head on the outside of the box the camera may then be focused. On the opposite side of the box is a second but smaller brass head from which a stem passes through a stuffing box to the interior of the box, and terminates in a flat disk. The disk lies opposite the release pin of the camera by which the mirror and shutter are set in motion. A light spiral spring wound about the stem between the outer head and the stuffing box keeps the stem thrust outward to its full extent. Pressure on the outer head causes the metal disk to strike the release pin so as to make the exposure.

In order to use the box, it is necessary to attach to it a weight heavy enough to submerge all but about the upper 6 inches of the hood. In the experimental apparatus used this weight was made by folding sheet lead to form a flat mass of the dimensions of the bottom of the box. The weight (not shown in the figure) was made slightly wedge shaped lengthwise and was attached to the bottom of the camera by wires passing beneath it and soldered at their ends to the sides of the box. As the camera would, in use, usually be pointed slightly downward, the thicker end of the weight was placed in front, so that the box floated with its front end somewhat lower than its back end.

#### USING THE APPARATUS.

The apparatus was used in the following manner: The magazine plate holder containing twelve plates was attached to the camera, the mirror depressed, the shutter set at the desired speed and width of slot, and wound. The dark slide was then drawn from the magazine holder, and the camera, thus made ready for an exposure in air, was placed in the box. Metal cleats soldered to the bottom of the box brought it always to the same position. The head on the right of the box was then pushed in until the fork engaged in the holes in the focusing head of the camera. The top was then put on the box and clamped down by the wing nuts as firmly as possible. The apparatus thus made ready was, when in air, as heavy a load as one man could conveniently carry. It was carried to a boat or, if it was to be operated near shore, to the shore. In working with the help of a boat the operator wades on or near the coral reef with his head and shoulders above the water. The boat, with an attendant on board, is anchored near. The operator, with the help of a water glass, now seeks a favorable place for operations. As he moves about the reef, the fish at first seek shelter in the dark recesses of the coral rock, but if he selects a favorable place and remains quiet they soon reappear. They are at first wary, but soon grow bolder and after half an hour or so pay but little attention to him. There is a great difference in wariness among different species of fish. At first only one or two species appear, demoiselles and slippery-dicks usually, then the number of species gradually increases until the shyest butterfly-fish and parrots come within 6 or 8 feet of the operator. He then has the camera passed to him from the boat. It floats with the upper part of the hood protruding and (fig. 1, pl. v) may be easily turned toward any point on the horizon or even tilted so as



to be pointed at a considerable angle upward or downward. The operator has now merely to direct the camera at the fish, while he focuses with his right hand. He must often wait some time before the fish come to the point selected or assume the desired attitude. Often they may be enticed by throwing in a bait of crushed sea urchins or pieces of crawfish. They are in constant motion so that he must as constantly focus. He often misses a long-awaited opportunity because the fish moves on or takes a wrong attitude before he has had time to focus sharply; but when the favorable time comes he presses the release stem and the exposure is made.

The apparatus must then be lifted into the boat, the cover removed from the box, and the camera taken out in order to reset the shutter and change the plate. It is best that all this be done by the attendant who remains in the boat, as the operator is thus left free to watch the fish, while at the same time the fish are not unduly frightened by the sudden movements that he would make in lifting the camera. With care, however, one person may do all the work necessary. He may anchor the boat near, pull it to him by means of a line, lift in the camera, and make all the necessary adjustments while he himself remains in the water. If the work is done near shore, the camera may be carried to shore after each exposure. In that case an assistant is very desirable, since the return of the operator after each absence disturbs the fish. Moreover, when near shore he is moving over the rock or sand bottom, not over the clean upper surface of the reef, and every considerable movement stirs up the bottom sediment so that some time must pass before the water is again clear enough to permit an exposure to be made. If an assistant is available, he may stand at a considerable distance from the operator, who sends the camera box to him through the water by a quick shove. The assistant, after he has carried it ashore and readjusted it, returns it in the same way.

The opening of the box after each exposure occupies some little time, and during this time favorable opportunities to make exposures are often lost. It would be better if a mechanism were provided by which the plates might be changed without opening the box, which would then remain in the water until twelve exposures had been made. Nevertheless it is possible with the apparatus described to make twelve exposures on coral-reef fish in about two hours, including the lifting of the box from the water between exposures and opening it to change plates. Any form of reflecting camera may be used and any form of plate holder. Films may also be used in rolls or packs. In addition to the reflecting camera the operator needs only a metal box of the structure described and of a form suited to his camera. This may be made by any good tinsmith at a cost of a few dollars.

A camera of this type inclosed in a suitable box may be held in the hand while in use, or it may be set upon a tripod of heavy iron, such as is shown in figure 4. Such a tripod would best have a top of the form shown in figure 2, but made of heavy iron instead of wood. The operator may descend in a diving suit, as Boutan did, and use the camera at the bottom in deep water either while holding it in the hand or while it is supported on a tripod. There should be no difficulty in focusing while looking through the plate-glass window of a diver's casque. For work on the coral reefs of the Tortugas, however, the writer has found that everything may be done from the surface, so that a diver's suit is quite unnecessary. He is told that similar conditions exist at the Bermudas. From his own experience in fresh water

he is inclined to believe that probably all the photographic work that it is desirable to do there may be done without the use of a diver's suit. The occasions on which such a suit is really necessary for work in either fresh or salt water are probably extremely rare.

If the objects to be photographed are motionless, or nearly so, time exposures may be made with this apparatus by suitably adjusting the camera before placing it in the box. For this use it is desirable to add to the box a third rod working through a stuffing box and so placed that by means of it the shutter may be released independently of the mirror.

Two photographs made by the method here described are reproduced on plate II. In figure 1, plate I, a butterfly-fish (*Chaetodon capistratus*) with a stripe through the eye and an eye-like spot on the tail is seen over a flat expanse of coral (*Meandrina*) and at the base of a large, branching gorgonian. The photograph was taken while the fish was in rapid movement. The expanded polyps may be seen on the gorgonian just above the fish and elsewhere. Figure 2, plate II, shows a group of parrot fishes, of at least three species, and several surgeons against a background of branching gorgonians on a ledge of rock. Near the center is a blue and yellow striped grunt, *Hæmulon flavolineatum*. At the left of this is a blue parrot-fish, *Callyodon caeruleus*. At the right of the grunt is a green parrot-fish, *Callyodon vetula*, about 18 inches long. Beneath the green parrot is a mottled parrot-fish (*Sparisoma?*). Above the grunt is a second mottled parrot and to the left of this a third. At the extreme left are two surgeons, *Hepatus hepatus*; a third is seen below the green parrot. Above the green parrot, in the background, is a purple sea fan, *Rhipidoglossa*. In most of the fish the details of the markings and the outlines of the scales are clearly seen.

These photographs were taken in water about 4 feet deep with a Goerz II. B. lens at a speed of  $f\ 5$ . The exposure was  $\frac{1}{3}$  second with Seeds P. orthochromatic plate and a no. 3 graphic color screen. The plates were fully timed and were developed rapidly with a strong pyro developer.

The apparatus used by the writer was experimental only and was meant for temporary use. It is easy to suggest improvements, the greatest of which would be a magazine plate holder for at least twelve plates and capable of being operated from outside the box which incloses the camera. There appears to be no such holder on the market. Magazine holders provided with a bag can not be used even though the leather bag of the plate holder be covered with a rubber bag so attached to the box inclosing the camera that the water can not enter, for the pressure of the water is such that even when the box is but partly immersed the rubber bag is forced into the box through the opening to which it is attached and the holder can not then be manipulated. This difficulty would be increased if an attempt were made to use the apparatus at a greater depth. What is needed is a magazine plate holder that presents a rigid exterior everywhere and that may be operated from the outside of the box by means of rods passing to the inside through stuffing boxes.

The box can be improved by reducing to its lowest limit the number of screws used to fasten the cover, for if but one or two screws had to be loosened to open the box much time would be saved in changing plates.

A part of the weight attached to the bottom of the box should be movable, so that it could be fastened either toward the front or toward the back. In this way the box could be made to float with the lens pointed at a considerable angle toward the bottom or toward the surface of the water. The operator would then be spared the very considerable effort necessary to hold the box in position when the lens is directed much above or below the plane in which the box floats.

The purpose of the writer has been to utilize an ordinary reflecting camera for subaquatic work by inclosing it in a suitable water-tight box without in any way lessening its availability for use in air when removed from the box. For use exclusively in water it would be best to design a reflecting camera that could be immersed directly in water without first inclosing it in a box. Such a camera would have to be of metal, water-tight, and would need to have the lens covered by a plate of glass. It would need to have only a small opening at the back on one side for inserting and removing the plates. Such an opening could probably be readily closed by a cover held in place by one or two screws. A camera of this sort, if made rigid enough to withstand the pressure of the water at even moderate depths, would be too heavy for convenient use in air. It would have the advantage of simplicity and increased ease of manipulation.

#### SOME LIMITATIONS OF SUBAQUATIC PHOTOGRAPHY.

Turbidity of the water sets a limit to subaquatic photography very much as fog or rain or partial darkness restricts photography in air. The water must be clear—that is, apparently free from particles in suspension. If instantaneous work is to be attempted the water must be free from the reddish color that often tinges fresh-water lakes and streams, for the tinge of red or yellow acts as a color screen and greatly lengthens the time necessary for the exposure.

When one looks from the air into the ocean water at the Tortugas or Bermudas, or into the fresh water of some of our northern lakes, it appears to be as clear as the air itself. When the surface is undisturbed, objects on the bottom at depths of 10 to 20 feet appear with as much clearness as though seen through air alone. The impression is created that such water is actually as clear as air, and that the water would offer no more obstruction to the vision of one beneath it than air itself. To test this impression the writer constructed a reflecting water glass somewhat like a reflecting camera without the lens. It was a metal tube 2 feet long, and contained two parallel mirrors, set at an angle of  $45^\circ$  with its long axis, and placed one at each end. By putting one end of this with its mirror beneath the surface and looking into the mirror at the other end, he obtained a view of the subaquatic landscape such as a diver obtains when he looks about him through the glass window in his casque. It is surprising to find how limited is the range of one's vision under these circumstances. Even in the clear sea water about tropical islands objects at a distance of 20 feet begin to appear indistinct, and beyond that distance they fade into a bluish haze which constitutes the background. This haze has not the effect of fog or smoke or twilight. It is as though the near distance were limited on all sides by walls of bluish translucent quartz which merged into the near water. From these walls the fish emerge and grow

rapidly more distinct as they approach. Into them they vanish suddenly as they recede.

Subaquatic photographs show the same lack of distance that so impresses the eye. Thus in the photographs shown on plate II the distance appears indistinct, partly because the objects in it are out of focus, but chiefly because they are enveloped in the bluish translucence mentioned above. It is therefore impossible under water to photograph objects at any considerable distance. To the photographer who is unfamiliar with the aspect of the subaquatic landscape this lack of distance in photographs of it seems a defect. But to the artist or naturalist who has seen things as they look to one beneath the water it is really a merit, since it shows these things as they are.

The source of this lack of distance is probably double. It is due in part to the fact that even the clearest water contains very many bodies in suspension, living organisms, and inorganic and organic particles. These, like dust in the atmosphere, interfere with distance vision. It is due also in part to the reflection of the light from the surface of the water. Light which has entered the water from above strikes upon and illuminates various bodies beneath the surface. From these a part of it is reflected to the surface of the water again. If it strikes the surface at an angle of more than  $48^{\circ} 35'$  with the vertical it is totally reflected and passes again into the water. Here it again strikes some submerged body and is again in part reflected to the surface and here again in part re-reflected. Thus shallow water is traversed in every direction by beams of light which intercross at every angle. These illuminate the opaque particles floating in the water and are deflected by reflection. They are also deflected by refraction through the more transparent organisms. In this way probably is produced the background of bluish-white opalescence which characterizes the subaquatic landscape. To one who knows that landscape, the background, hiding many mysteries, adds to it character and beauty. A photograph that failed to show it would be lacking in character. Boutan (1893), who discusses this subject, made use of a blue color screen and believed that he obtained greater distance in his subaquatic pictures by this means. In his more recent work (1900, p. 283) he abandoned the use of the color screen. He obtained clear pictures of near objects by using a shade above the lens, as already described. Boutan appears never to have obtained clear pictures of more distant objects. The writer has made use of an ordinary yellow color screen (graphic no. 3) but is unable to say with certainty that it adds anything to the distance in his pictures. The subject needs further study.

A second characteristic of the subaquatic photographs that strikes the photographers unpleasantly is their flatness. Objects of all sorts appear lacking in thickness or rotundity and do not cast abrupt or heavy shadows. This peculiarity the writer believes to be due to the reflection of light from submerged objects into the water at the water's surface. Light thus reflected on the subaquatic object from the bottom beneath and from the surface above and at all angles takes out of it much of its roundness. It takes out the shadows very much as a photographer in his studio may take them out by a suitable adjustment of reflecting screens. Along with this flatness of the individual objects in the subaquatic photograph there is abundance of contrast between different parts, as may be seen in plate I.

This lack of distance and this flatness combined with contrast, so characteristic of the subaquatic photograph, are not real defects. They are rather truthful representations of the conditions that actually obtain. To the photographer accustomed only to photographs made on land they appear to be defects. To one who knows the subaquatic landscape they are, from the artistic standpoint, sources of beauty. From the scientific point of view they undoubtedly place limitations on subaquatic photography.

## LITERATURE CITED.

## BOUTAN, L.

1893. Memoirs sur la photographie sous-marine. Archives de Zoologie expérimentale et générale, ser. 3, t. I, p. 280-324, pl. xviii and 4 fig.
1898. L'instantané dans la photographie sous-marine. Comptes rendus de l'Académie des Sciences, Paris, t. cxxvii, p. 731-733 (Novembre).
- 1898a. L'instanté dans la photographie sous-marine. Archives de Zoologie expérimentale et générale, ser. 3, t. vi, p. 299-330, pl. xx-xxiii, 8 fig.
1900. La photographie sous-marine et les progrès de la photographie. Paris, 1900, 332 p., 52 fig., 12 pl.

## FABRE-DOMERGUE.

1898. Photographie d'aquarium. Photo-Gazette, vol. vii (8).

## JORDAN, D. S., and EVERMANN, B. W.

1902. American food and game fishes. 573 p., illus. New York. (Contains many photographs from life by A. Radclyffe Dugmore.)

## REIGHARD, JACOB.

1903. The natural history of *Amia calva* Linnæus. Mark Anniversary Volume, p. 57-109, pl. vii. (Plate reproduced by lithography from colored photographs of *Amia*.)

## RUDAUX, L.

1908. La photographie à travers l'eau. La Nature, no. 1824, 9 Mai, 1908, p. 360-363. (Translation in Literary Digest of June 13, 1908.)

## SAVILLE-KENT, W.

1893. The Great Barrier Reef of Australia. Its products and potentialities. London, p. i-xviii+1-387. Photo-mesotype pl. i-xlvi, chromo pl. i-xvi.

## SHUFELDT, R. W.

1898. The camera and the aquarium. Photo Era, vol. ii, p. 147-150, 3 fig.
1899. Experiments in photography of live fishes. Bulletin U. S. Fish Commission, vol. xix, 1899, p. 1-5, pl. 1-9.

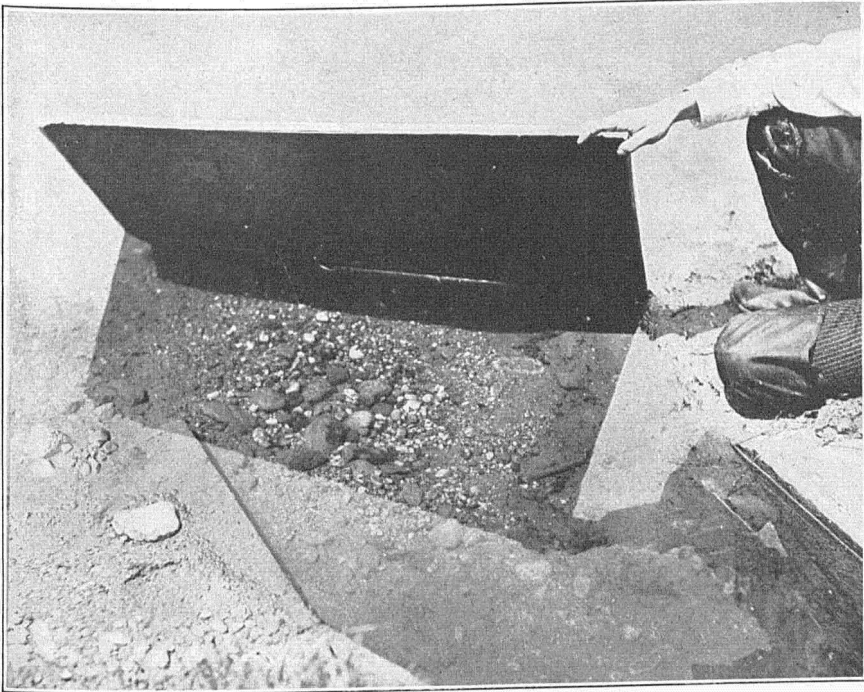

FIG. 1. PHOTOGRAPH OF THE NEST OF A SMALL-MOUTHED BLACK BASS (*MICROPTERUS DOLOMIEU*) TAKEN WITH THE AID OF A SCREEN, THE CAMERA ABOVE WATER.



FIG. 2. BROOK LAMPREYS (*LAMPETRA WILDERI*) ON THE NEST, PHOTOGRAPHED THROUGH THE WATER GLASS SHOWN IN FIGURE 2, PLATE IV, IN ABOUT 8 INCHES OF RUNNING WATER.

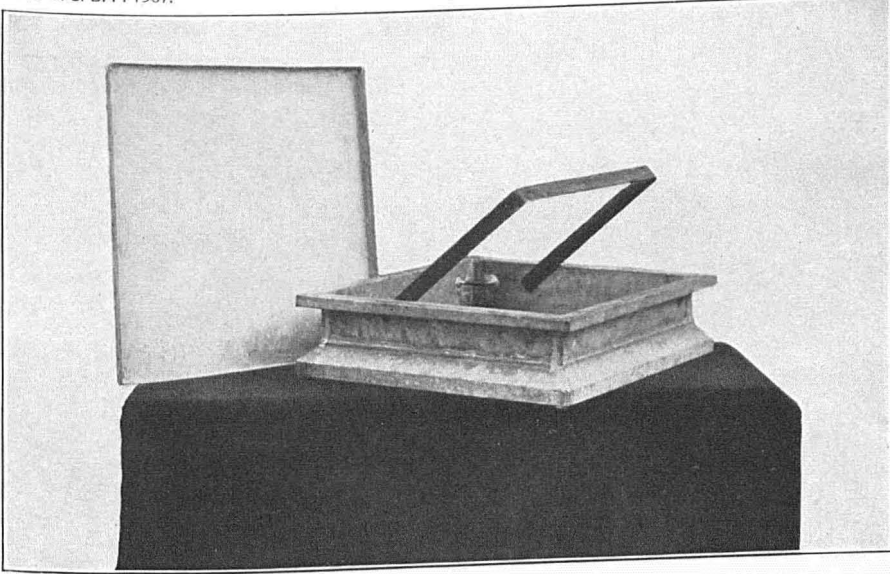

FIG. 1. WATER GLASS DESIGNED BY THE WRITER TO BE USED FOR OBSERVATION OR PHOTOGRAPHY OF OBJECTS UNDER WATER.

The cover is shown at the left.

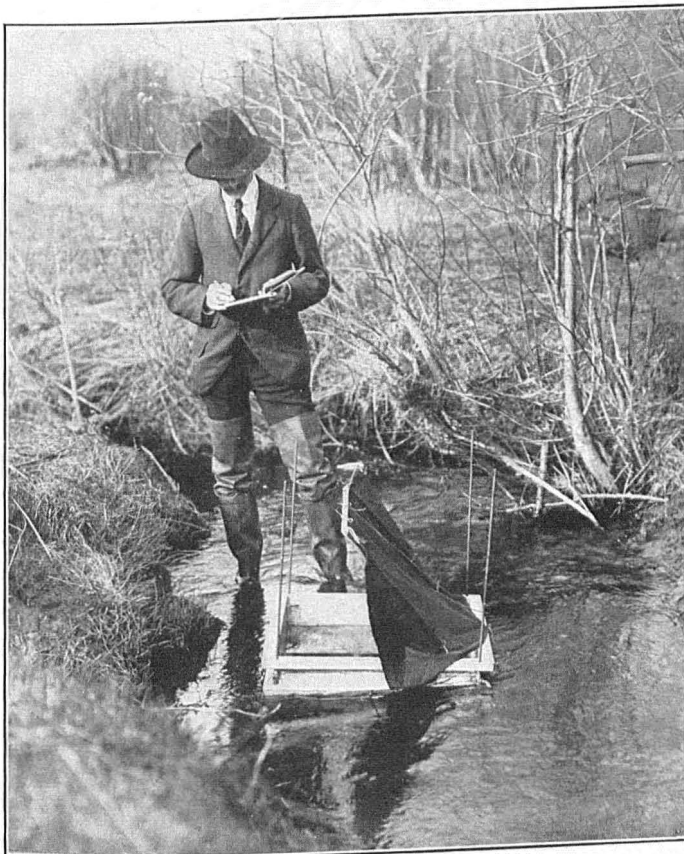

FIG. 2. TWO-FOOT WATER GLASS SUPPORTED ON FOUR LEGS AND PROVIDED WITH SCREEN, AS USED FOR STUDYING AND PHOTOGRAPHING LAMPREYS (*LAMPETRA WILDERI*).



FIG. 1. PHOTOGRAPH SHOWING THE METHOD OF USING THE REFLECTING CAMERA WHEN INCLOSED IN THE WATER-TIGHT BOX FOR SUBAQUATIC WORK.

The upper part of the box covering the hood rises above the surface, while the lower part, containing the camera proper, is under water. The operator is looking into the hood through the plate glass in the top of the box. With his right hand he focuses; with his left makes the exposure.

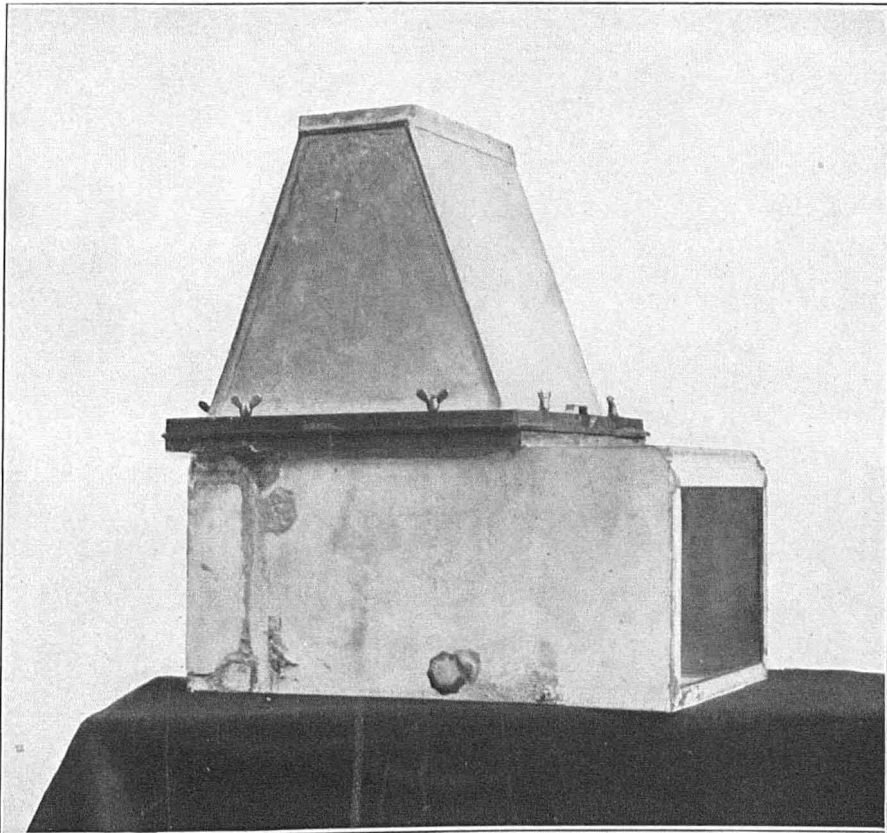

FIG. 2. GALVANIZED-IRON BOX WITH PLATE-GLASS FRONT, DESIGNED BY THE WRITER TO CONTAIN A 5 BY 7 REFLECTING CAMERA WHEN USED UNDER WATER.

For description see text, page 62.