THE ARTIFICIAL PROPAGATION OF THE RAINBOW TROUT.

By GEORGE A. SEAGLE,

Superintendent of the United States Fish Commission Station at Wytheville, Va.



4.—THE ARTIFICIAL PROPAGATION OF THE RAINBOW TROUT.

By GEORGE A. SEAGLE,

Superintendent of the United States Fish Commission Station at Wytheville, Virginia.

The following brief treatise on the most modern and successful plans for the artificial propagation of the rainbow trout (*Salmo irideus*) has been prepared for the information and instruction of all who appreciate the advantages of fully stocking our streams with suitable fishes, thereby increasing the extent and variety of our food products and lessening their cost. It is written from an entirely practical standpoint, and it is hoped that with the aid of the accompanying illustrations all the necessary information will be conveyed in such a manner as to enable those interested in the subject to appropriate it to their own use and advantage. We have avoided, as far as possible, the use of scientific and technical terms and have attempted, in the plainest and simplest manner, to state the habits of this interesting and important species of fish and the methods by which they are now successfully propagated artificially at the Wytheville Station, explaining the design and construction of the requisite apparatus, the manner of building the ponds, and giving such other information as has been gained by 14 years of experience in the practical part of this work.

This fish is not indigenous to our eastern waters. Its original habitat was the Pacific Coast, extending from Mexico to the Canadian border, and possibly still farther north. In this extensive section of the West its name varied with different localities; "redsidés," "mountain trout," "brook trout," "golden trout," etc., were some of the appellations; but in the States east of the Mississippi River the names generally given are "rainbow trout" or "California trout." It was first introduced into the eastern waters by the United States Fish Commission in 1880, but it is probable that specimens of it or its spawn were brought here prior to that time by some of the State commissions or by private enterprise. Be this as it may, the Wytheville Station was one of the first Government hatcheries to rear and handle them, and it was here that the writer made their acquaintance in the spring of 1882.

Size.—This depends chiefly upon the waters in which they are found, the size of the stream, the temperature of the water, the amount of food it contains, etc. The average weight of those caught from streams in this locality is probably less than a pound, but some weighing 6½ pounds have been taken. In the Ozark regions of Missouri they reach a weight of 5 to 10 pounds. In some of the cold mountain streams of Colorado their average size would not be more than 6 or 8 ounces; while in lakes in the same locality, where the water is moderately warm in summer and food is plentiful, they grow to weigh 12 and 13 pounds and reach a length of from 25 to 28 inches. In Au Sable River, in Michigan, they attain a weight of 5 to 7 pounds. In their native streams of California they are often caught ranging in size from 3 to 10 pounds, but the average would probably be from 1 to 2 pounds. The largest specimen ever produced in the ponds at the Wytheville Station, and fed artificially, weighed 6½ pounds, but many others in the same pond will weigh from 1 to 3 pounds.

Rate of growth.—The average growth, under favorable circumstances, is about as follows: One year old, from $\frac{3}{4}$ to 1 ounce; two years old, from 8 to 10 ounces; three years old, from 1 to 2 pounds; four years old, from 2 to 3 pounds. They grow until they are 8 or 10 years old, but the rate of growth diminishes with age. Some will grow much faster than others under any circumstances, but it may be truly said that the rate of growth is a question of food and temperature of water. In water at 60° and with plenty of food, fish one or two years old will double their size several times in a single season; while in water at 40° and with food limited, the rate of growth would probably be less than 100 per cent in the same time.

Temperature of water.—Mr. Livingston Stone says of brook trout:

Under this head it may be suggested that the quantity and force of current and vigor of the water have much to do with the degree of temperature at which trout will live. For instance, when water does not possess much vigor, is deficient in quantity, and sluggish, it will not support trout in so high a temperature as when it is vigorous, plentiful, and rapid. I think it is safe to say that sluggish flat water at 70° is dangerous, if not fatal, to trout, while they will live in vigorous, rapid water which occasionally runs to 80°. I have found 85° to be fatal to them in all kinds of water. (Domesticated Trout, pages 13 and 14.)

The above will apply, in the main, to rainbow trout also; rainbow trout will live, however, in warmer water than brook trout; they will thrive in "vigorous" water at 85°, especially where there is some shade; in ponds I would consider that temperature dangerous, even with shade and a fairly good current.

Eddible qualities.—The trouts are generally recognized as being the best of all pan fish; but, as regards their relative value in this respect, there is difference of opinion. In comparing the rainbow trout with the brook trout (*Salvelinus fontinalis*), I find that conflicting reports come from all sections; even in the same locality I find much difference of opinion, so it may be said that it is all a matter of individual taste. Some regard the brook trout as having the finer flavor; others think that the rainbows are deserving of that distinction, while still others think there is no difference in the flavor of the two species.

Gameness.—The rainbows are quite game; they are active biters, and make a strong fight for their liberty.

Spawning ponds.—The construction of the spawning-ponds, with reference to their shape and size, is of vast importance to the trout-culturist. I regard the best size for these ponds about 15 by 50 feet, and from 3 to 3½ feet deep, constructed entirely of wood and shaped as shown in plate 89. A pond shaped in this way gives the best possible water circulation in all its parts, and there are no corners for the excrement and other foul matter to lodge in. The bottom of the pond should be built with a gradual elevation toward the upper end of about 2 inches in the length of the pond. This makes the pond practically self-cleaning; nearly all the foul matter will work through, and what is left in it can be easily gotten rid of by drawing the water down low, and letting the fish work it out. This saves handling the fish, which is very important, especially when it is near their spawning time.

Guard-rack.—This should be put in on an incline of about 45 degrees and made of thin narrow slats, as shown at C (plate 89). If the water is to be used over again in ponds below, a receiver should be built underneath the bottom of the pond at the lower end, between the foot of the guard-rack and the dam-boards. The floor of the pond immediately over this receiver is to be cut away and a grating set in. This will allow matter to fall through into the receiver and from there be washed out through the

- A. Raceway to pond below.
- B. Dam.
- C. Guard rack.
- D. Gate to sluice.
- E. Sluice.
- F. Division boards.
- G. Dam board, in mouth of raceway.
- H. Raceway.
- I. Square net for capturing spawners.

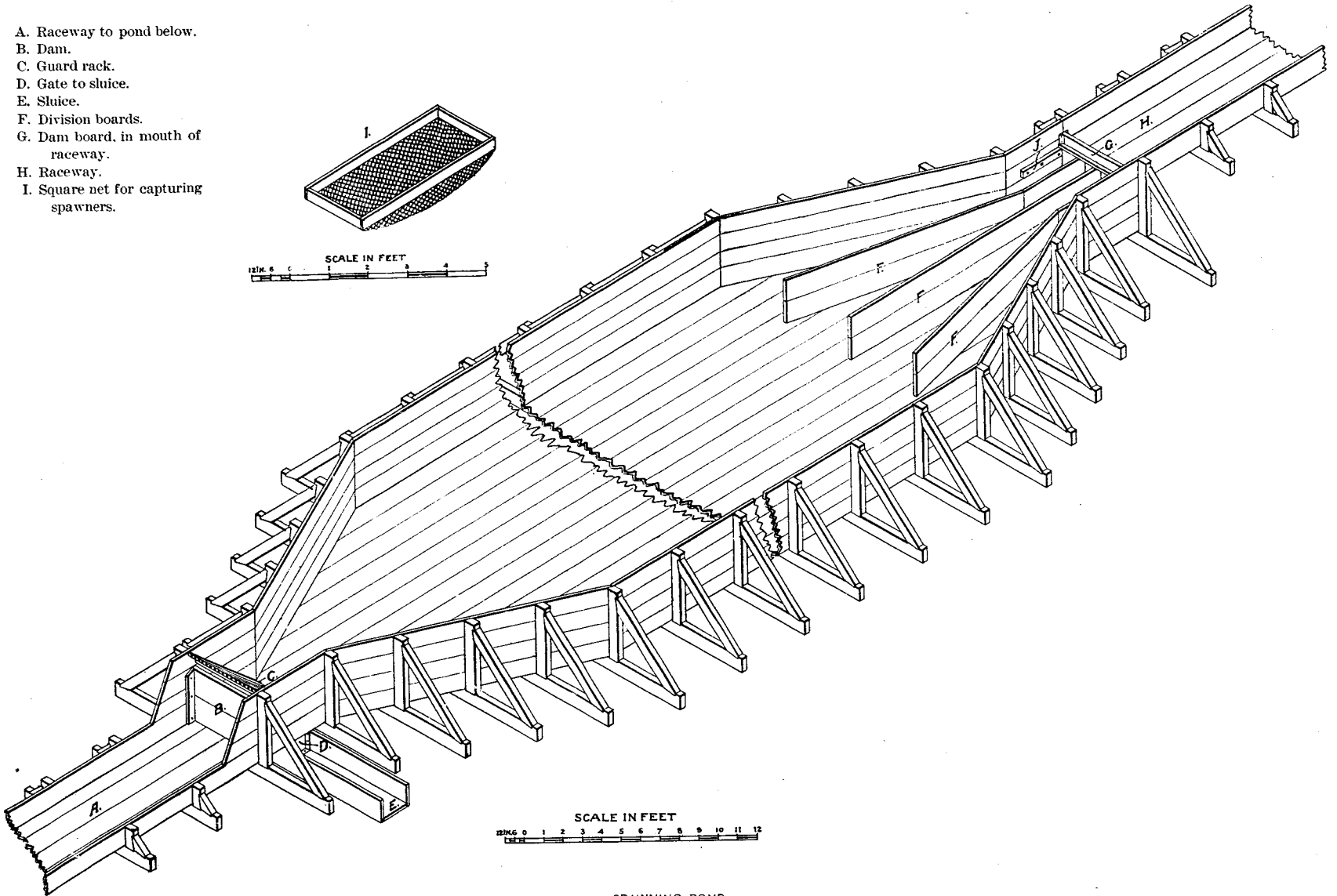
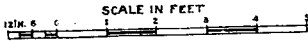
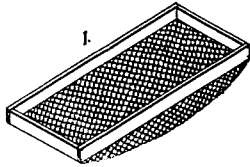

SPAWNING POND.

sluiceway, which taps the receiver, by drawing the gate, shown at D. I prefer to have the sluiceway (E, plate 89) covered and led off under ground to a general waste-ditch, or it can lead to any point desired.

Raceway.—The pond should be constructed with a spawning-race 1 by 4 feet, and about 25 feet long, placed at the upper end of the pond, as shown at H. This should be cut in its depth (1 foot) from the top of the pond, as shown in the illustration. Three division boards (shown at F), about 12 feet long and of suitable width to come within 2 inches of the surface of the water when the pond is filled, should be firmly fixed to the bottom of the pond. The object of these boards is to form four avenues leading to the raceway, so that one or two pugnacious fish (partly stripped spawners are the worst) can not command the entire approach to the raceway and keep back spawners inclined to enter. There should be a dam across in the mouth of the raceway, about 4 inches high (shown at G), for the purpose of bringing the water to that depth in the lower end, so that spawners that enter may have sufficient water to swim around in and feel free, and not be inclined through fear to return to the pond.

Depth of water in the pond.—The water in the pond should be of sufficient depth to bring its surface within 6 inches of the top of the dam in the raceway; this will give the fish, in entering the raceway, a jump of about 7 inches, allowing 1 inch for the depth of water on the dam in the raceway. I have found that distance more satisfactory than any other; at that distance spawners will enter freely, and without difficulty, and only spawners will go up. If a jump of much less than 7 inches is given, so that fish can enter the raceway without some exertion on their part, fish of all classes will go up, many apparently through mere curiosity, with no inclination to spawn. This is very undesirable, as the spawners prefer to be by themselves; if they did not they would probably not go up the raceway at all.

Stocking the pond with breeders.—For a pond such as I have described (15 by 50 feet) I would recommend from 1,000 to 1,500 fish; this, however, is a question that every trout-culturist must decide for himself, as there are several things which should govern it, such as the size of the fish, water supply, temperature of water, amount of shade, etc. The fish will not thrive so well if crowded. As regards the proportion of sexes in stocking the spawning-pond, I prefer the ratio of two-thirds females and one-third males. I consider that a larger number of males are a disadvantage. They are in the way in every respect; better cull them out at spawning time and give the room they occupy to more females. I also strongly recommend culling the breeding stock every year and throwing out all the males that will not be needed for the next season. Keep only young males when you have them; they are preferable. Throw out the blind and emaciated fish of both sexes; they can not be of any service to you. It is only the perfect specimens that it pays to keep.

Food.—Trout, as is well known, are not naturally vegetarians; in fact, they are generally supposed to be strictly carnivorous, and when a plentiful and cheap meat diet can be gotten, I do not think it can be improved upon; but this can not always be obtained in sufficient quantities and at a price that will justify its exclusive use. In that case I would recommend a mixed diet of liver and mush, prepared as follows: Make a mush of wheat shorts, or middlings, and boiling water, by stirring the shorts into the boiling water until it is as thick as it can be mixed well. As soon as it is cool it is ready for use. This mush will keep for several days, even in warm weather, by keeping it in a cool place. After grinding or chopping the liver fine, mix in the mush thoroughly, in any desired proportion, up to four-fifths of the whole. At Wytheville,

when liver is plentiful the food is mixed two-thirds mush and one-third liver. When this kind of meat is scarce it is mixed to suit the amount of it available. I have fed this vegetable and meat mixture to trout at the Wytheville Station for 13 years, and it has proven entirely satisfactory. Since its introduction at Wytheville it has also been tried by Mr. W. F. Page, superintendent of the Neosho station, and others, with satisfactory results. For grinding or chopping the liver, I do not know of a machine that is equal to the Enterprise meat-chopper. I have had one of these machines in use for eight or ten years, and I find that it does its work in the best possible manner, as there are no strings or chunks left to choke the fish. There are several sizes of this machine made, with extra perforated plates, having different-sized holes, from one-twelfth to one-fourth of an inch in diameter, so that the meat may be prepared coarse or fine, to suit the size of fish. For the small fry it will be necessary to use the plate having the smallest holes and to grind the food over two or three times, until it is made fine enough for use.

Feeding the fish.—The method generally practiced is to throw the food into the pond by handfuls, or by dipperfuls. I consider this method altogether wrong, as it causes the fish to come together in great numbers and in a rough-and-tumble manner; and in struggling with open mouths to get a bite of the food they often scar themselves up, injure one another's eyes, and sometimes pluck them from their sockets. This I consider one of the main causes of blindness among pond-fed fish. The method of feeding which I would recommend is to walk along the pond its entire length to the upper end; the fish will soon follow; then take a handful of the food and throw it underhanded down the pond; this will cause the food to skim along the surface of the water, come to pieces, and scatter in every direction. The fish will follow the food and take up what was thrown out, and then return to the head of the pond to watch for the next handful. Repeat the operation again and again until the work is finished. In following this method of feeding, the fish are not brought together in an abrupt manner, the food is well scattered over a good portion of the pond, and the fish are all heading in the same direction while they are feeding, thereby saving their eyes, and avoiding bruises and scars. The amount of food for a given number of trout must depend upon the size of the fish and the temperature of the water. Fish will not take food as freely in a low temperature as they will when the water is warmer. With water ranging in temperature from 50 to 60 degrees I would recommend for 1,000 yearling fish, ranging in size from 3 to 5 inches long, about three-fourths of a pound for their daily ration, while for the same number ranging in size from 8 to 12 inches about 12 pounds per day will be required. I prefer to have my fish fed twice a day, at regular hours morning and evening, giving half of the above-stated quantity at each feeding. This will keep the fish in a thrifty and growing condition. As the fish increase in size the amount of food should be increased proportionately.

Amount of water necessary for a spawning-pond.—There is no rule, so far as I know, that will apply to this matter at all times and in all places. It must necessarily be governed by the temperature of water, size and shape of the pond, and the number and size of the fish to be supported, the amount of shade, etc. For a spawning-pond, such as I have described, where the water is plentiful, I would give at least 200 gallons per minute. Not that I consider that amount necessary for the support of the fish, but the pond will be kept cleaner and the fish will enter the raceway better at spawning time. Under no circumstances would I give, with water ranging from 50 to

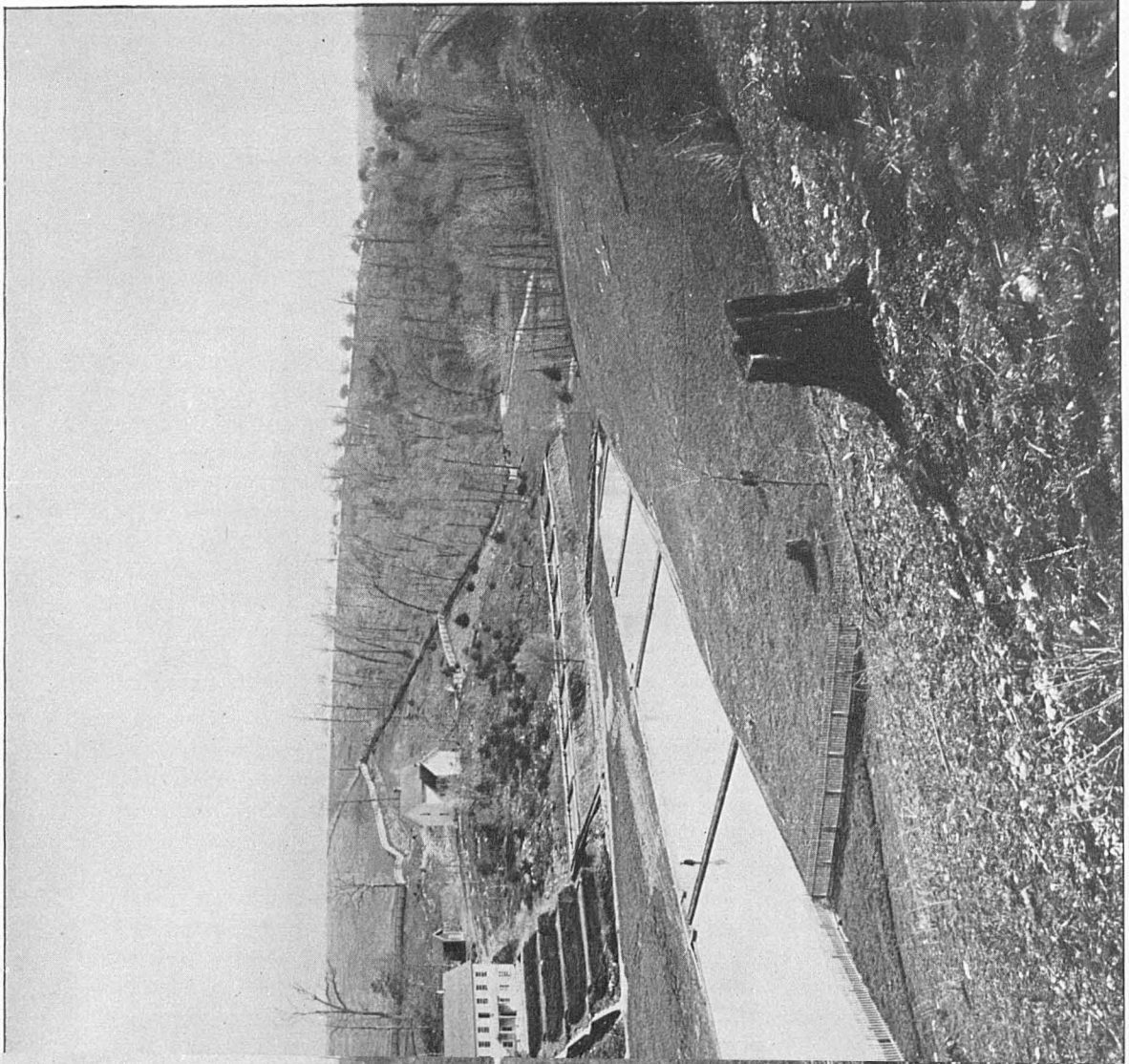

GENERAL VIEW OF WYTHEVILLE STATION FROM RAILROAD TRACK.

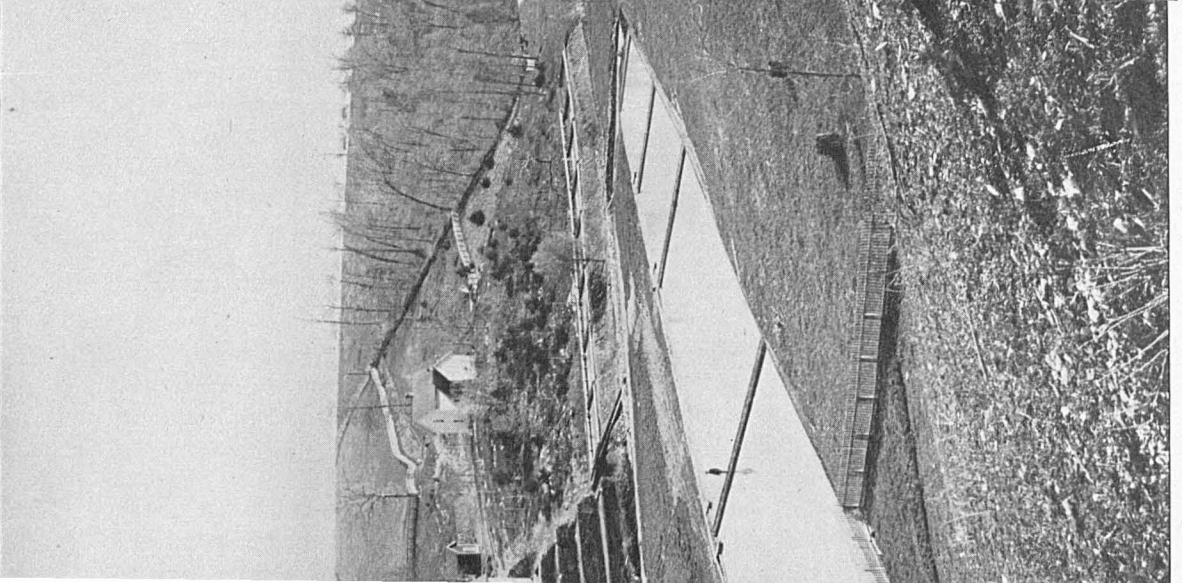

VIEW OF WYTHEVILLE STATION FROM RAILROAD TRACK.

55 degrees and with all other conditions favorable, less than 75 gallons per minute. I consider that amount about the minimum for a pond built and stocked as I have recommended. In order to maintain an even temperature in the ponds they should be banked against the sides and ends with earth, which, of course, covers the framework that is shown in plate 89. The embankments should be broad enough on top to admit of a good walkway around the ponds.

Spawning season.—The spawning season varies with the locality and the temperature of the water. It is usually two to four weeks later in the streams than where the fish are kept confined in spring water. In the ponds at the Wytheville Station we expect to find spawners any time after the 1st of November; the season is well started by the 15th, and it generally closes about the 1st of March. December and January are our best months. In California the season runs from the 1st of February to May, and in Colorado it begins early in May and probably extends to July.

Natural spawning.—I have never had an opportunity of seeing the rainbows spawn naturally in the streams, but I have found their nests in our ponds and raceways at this station when it used to be our custom to keep gravel in the raceways for the purpose of inducing the spawners to enter. We do not use gravel about the ponds or raceways now. These nests were about the size of a dinner plate, the gravel forming them being concaved to make a depression in which the eggs were deposited. After being fertilized by the male fish the eggs would be lightly covered over with small gravel, and in this condition they are left to their future destiny.

Artificial spawning.—Where spawning ponds are provided with suitable raceways, the fish will ascend from the ponds into them, seeking a place to make their nests. They are then ready to be taken out and their spawn expressed. To take the fish from the raceway, drop the square net (I, plate 89) in on the cleats which are nailed against the side walls in the approach, shown at J; then raise the dam in the mouth of the raceway and scare the fish back into the net; this being accomplished, lift the net out and pour the fish gently into the spawning-tub, which should always be at hand ready for use. If more fish are in the net than can be lifted out at one time, use a landing net to take out a part of them before moving the square or spawning net. Never put too many fish in the tub at one time; they will become restless and sick before you can handle them and strip them of their spawn.

Taking the spawn.—There are two methods in general practice in taking and impregnating the spawn of fishes; one is to allow the eggs to fall into a pan containing more or less water, to be immediately followed by the milt or seminal fluid of the male fish, mixing the milt well with the water and eggs in the pan. The other is known as the Russian or "dry" method. The water is omitted and the eggs are taken in a dry pan with the milt. In this case it makes but little difference which is taken first, the eggs or the milt, but the one should immediately follow the other and they should be thoroughly mixed together in the pan. After giving the milt and eggs time enough for thorough contact, but before the eggs begin to adhere to the bottom of the pan, add water to the depth of about 1 inch in the pan, and let the eggs remain two or three minutes longer, keeping them moving gently by turning the pan to prevent adhesion. This being accomplished, pour the milt off and add clear water to the pan, allowing the eggs to remain until they separate, which will be in from 10 to 20 minutes. If it is convenient to take the eggs to the hatchery, before time for pouring off the milt and water, I prefer to rinse them off there and then place them on the hatching-trays, which have been previously arranged in the water in the hatching-troughs,

allowing them to separate there.¹ Both of these methods have been thoroughly tried at Wytheville, and each proved satisfactory when the spawners were in good condition and the work was well done, but I am inclined to favor the "dry" method under most circumstances, as it seems to give the best results.

If the weather is freezing cold, I prefer either taking the eggs in water or using two pans, one set in the other, with water from the pond in the bottom pan to prevent the eggs from being chilled. To manipulate the fish in taking the spawn and to do it without injury to the fish, is a very delicate and particular task, and one that requires experience. Almost anyone can squeeze the spawn from the fish, but to do it without injuring or even killing the parent fish, is something that very few spawn-takers ever learn to do. In taking hold of the fish, after they have been placed in the spawning-tub, it is best to catch the spawner by the head with the right hand, having the back of your hand up; at the same time slip your left hand under the fish and grasp it near the tail, between the anal and caudal fins. A fish caught in this way can be easily turned over, as it is brought out of the water, so that its abdomen will be up and in the proper position for spawning by the time the spawning-pan is reached. If the fish struggles, hold it firmly but gently, until it becomes quiet. If you have it in the right position it will struggle only for a moment. If the fish is a large one, put its head under your right arm, and when the struggle is over, pass your right hand down the abdomen until the point midway between the pectoral and ventral fin is reached; then with the thumb and index finger press the abdomen gently, at the same time slipping the hand forward toward the vent.

If the eggs are ready to be taken they will come freely and easily. If they do not come in this manner, put the fish back in the pond for some future time. If the eggs come freely from the first pressure, slip your hand back and repeat the operation, beginning at or near the ventral fin. After the first pressure has been given, by holding the head of the fish higher than the tail, all of the eggs that have fallen from the ovaries and are ready to be expressed will fall into the bottom of the abdomen, near the vent, so that it will not be necessary to press the fish again over its vital parts, the eggs having left that part of the body. All of the eggs that have fallen into the abdomen below the ventral fin can be easily expressed, and without danger of injuring the fish. The danger lies in pressing the fish over its vital parts after the eggs have left that part of the body. If this method and these directions are judiciously and carefully followed, little if any damage will result to the matrons thus handled. As an illustration, I may mention the fact that I have kept fish for 14 years, and extracted from them a full quota of eggs each recurring season during their egg-producing term, which is from 10 to 12 years.

The male fish is to be treated very much in the same manner, taking only what milt will come freely. More milt is required in taking eggs by the "dry" method than when water is used, as enough should be in the pan to allow good circulation through all of the eggs. If only a small amount of milt can be gotten, use water to make up the required amount of liquid for this purpose. Very little milt will often give good impregnation, but when milt can be gotten plentifully, be sure that you use enough to give good results. After stripping the fish of their spawn, remove them

¹Some trout-culturists recommend letting the eggs remain in the milt and water until they separate, but, as it is generally acknowledged that the spermatozoa becomes inactive in 2 minutes after coming in contact with the water, I can see no good reason for leaving this dead milt on the eggs, as they must necessarily absorb it to become freed from the adhesion. I think it would be more natural for them to absorb only pure water.

from the spawning-pond, being careful to put the spent females in one pond and the males in another, as the males are very pugnacious about this time and are not very particular about what they fight.

Incubation and hatching of the eggs and care of fry in the hatchery.—The eggs of trout are usually incubated and hatched on trays, which are placed in the water in troughs and boxes of various sizes and shapes. I prefer troughs which are made and set in pairs, as shown at fig. 1. These troughs are about 15 feet long, and made of the best pine lumber, dressed to $1\frac{1}{2}$ inches thick. The bottoms are 14 inches wide and the sides are 8 inches wide. The guard screen (A) should be put in about 14 inches from

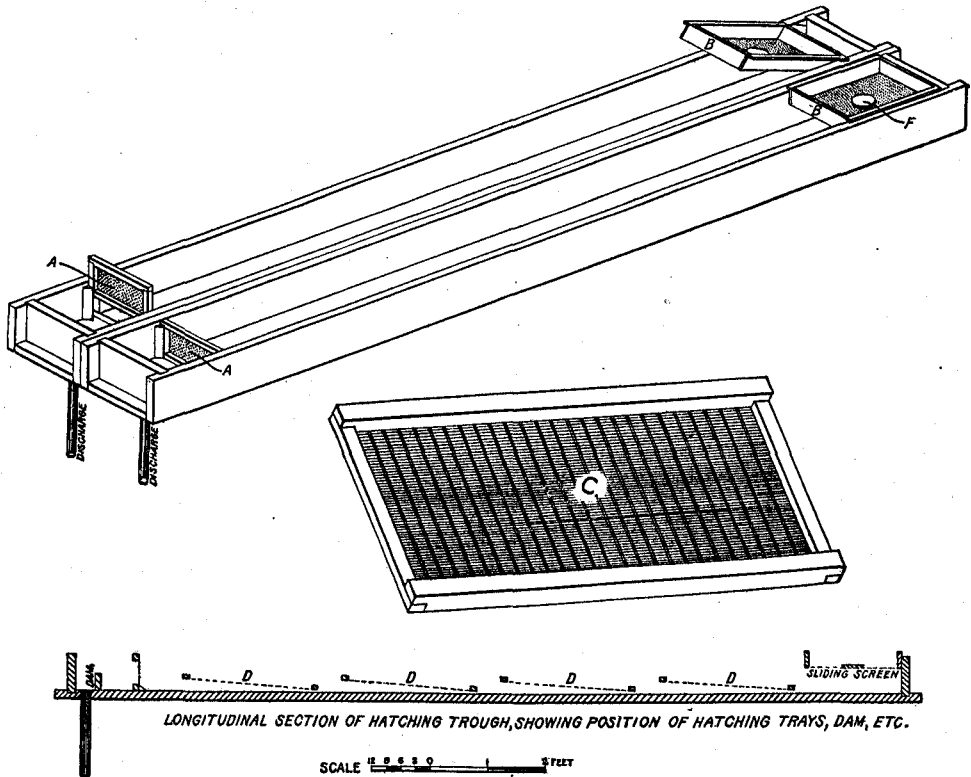

FIG. 1.—Hatching troughs, guard screen, etc.

- | | |
|--------------------------------|--|
| A. Guard screen. | E. Tin tray for use in muddy water (see fig. 2). |
| B. Horizontal sliding screen. | F. Block for water to fall upon. |
| C. Hatching tray. | G. Brackets (fig. 2). |
| D. Position of hatching trays. | H. Feet (fig. 2). |

the lower end (inside). It consists of a frame made as wide as the trough is deep and as long as the trough is wide, and put in with beveled lining on both sides at the end, but across the bottom the lining should be put only on the upper side; this will assist in keeping the parts clean. Instead of wire on the guard-screen, I prefer perforated tin, with perforations a sixteenth of an inch for very young fry, and larger perforations as the fish grow. The dam is put in from 4 to 5 inches from the lower end, and is simply a plain board $3\frac{1}{4}$ inches wide. In the upper end of my troughs, I use horizontal sliding screens (shown at B) with perforated tin bottoms, instead of the vertical screens formerly used. The advantages claimed for the sliding screens are obvious;

the fish are allowed to pass up under the screen—the most important part of the trough—and there receive a shower bath, which keeps them clean even in muddy water; there is no jumping over the guard screens or the sides of the troughs, and there are no obstructions across the bottom of the troughs to cause the alevins (very young fry) to suffocate, as was so often the case when the vertical screens were used. In feeding the fish, or examining into their condition, the screens can be either slid back or raised out of the way, as shown in the illustration.

Hatching trays.—I prefer the hatching-trays made fully twice as long as wide, because they are then much easier to adjust in the troughs and hold more eggs, which, of course, makes fewer trays to handle and thus facilitates the work. The trays that I use are $13\frac{1}{2}$ by 28 inches (shown at C, fig. 1). The sides of the frame are made of good pine lumber, dressed 1 inch square; the ends are dressed $\frac{1}{2}$ by 1 inch, and are cut into the sides their thickness from the under side, forming a smooth surface on that side for the wire bottom. The wire used on the trays is woven with 8 threads to the inch, with a mesh $\frac{7}{8}$ of an inch long. The wire should be well galvanized after it is woven, in order to prevent rusting at the laps.

Placing the trays.—Four hatching-trays are placed in each trough and are secured

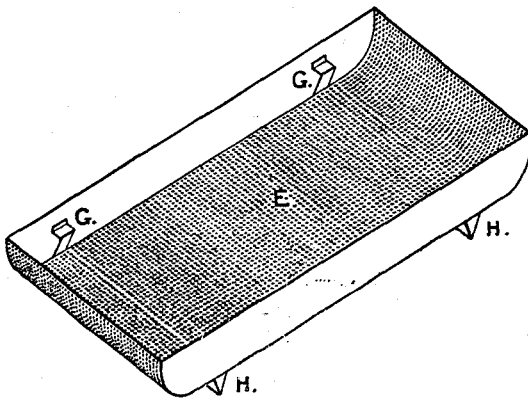

FIG. 2.—Tin tray for use in muddy water.

in place by means of keys or wedges, and should be from 1 to 2 inches lower at the end toward the head of the trough, as shown at D, D, D, D, fig. 1. In this way the trays will hold from 12,000 to 15,000 eggs with perfect safety. If we should be unfortunate enough to have muddy water during the hatching season, we use a tin tray with perforated bottom, shown at E, fig. 2. This tray is made $13\frac{1}{2}$ inches wide and 32 inches long, and sets inside of the hatching-trough on feet, H, raising it 1 inch above the bottom of the trough. The hatching-tray, containing the eggs that are hatching, is placed inside of the tin tray, and rests on the bracket shown at G. The little fish, as they hatch out, fall from the hatching-tray on the perforated bottom of the tin tray, and by their movements work the sediment through, leaving them on a clean bottom and in no danger of being smothered. These tin trays are also useful in counting fish, or in holding small lots of fish of different species in the same trough.

Number of eggs to a trough.—Troughs 15 feet long will admit of 4 hatching-trays in a single row; each tray will safely carry 12,500 eggs, making 50,000 eggs to a trough; this is enough to work easily, but if it is necessary in order to make more room a double row of trays may be put in, one tray resting on the top of the other. In this way the trough would contain 100,000 eggs, which I consider about its full capacity. The troughs will carry this number up to the time of hatching, by placing the trays lower at one end than the other, as previously described.

Care of the eggs.—After placing the eggs on the trays, they will need no further attention until the hatching begins, except to keep them clean and the dead eggs picked off. These dead eggs may be known by their turning white. The eggs should be examined once every day for that purpose. After the eye-spot can be plainly seen

it is a good idea to run a feather through the eggs for the purpose of changing their position on the trays and to disclose any dead eggs or foreign matter that may be hidden underneath. Great care should be exercised in handling the eggs at any time, but after the first or second day from the taking until the appearance of the eye-spot, they should be handled with especial care, and then only when it is absolutely necessary, as during this period they are very delicate, and a good shaking up, or even passing a feather through them, will cause a heavy loss.

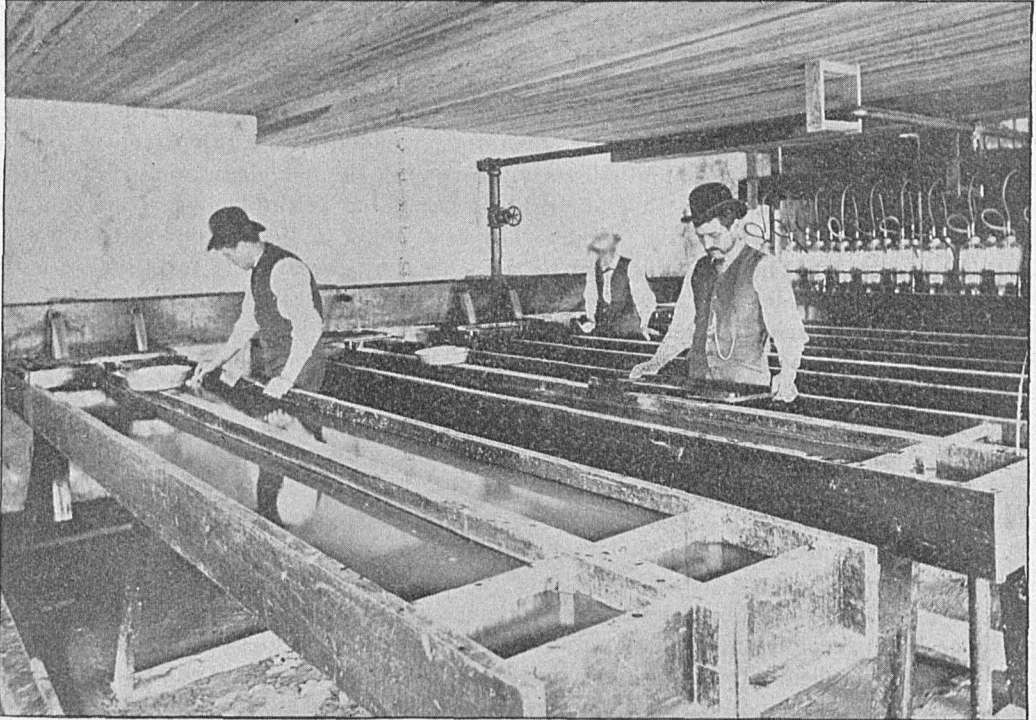

FIG. 3.—Interior view of Hatchery showing men fishing out Dead Eggs.

Time required to hatch the eggs.—The time required to hatch trout eggs, or fish eggs of any kind, depends almost wholly upon the temperature of the water in which



and smothering in any part of the trough. If it is necessary to hatch a much larger number in one trough, the sliding screen should be so arranged that the water will fall well up against the end of the trough. This can be done by raising the screen and turning it back against the reservoir, or by putting in a wedge-shaped block for the water to fall upon, turning the thin side of the block to the upper end of the trough. I have had 50,000 trout hatch in one trough prepared in this way, without any loss from suffocation. I would not, however, recommend hatching such a number together in one trough, if it can be avoided, as there will be too many to raise up to feeding time, and they would necessarily have to be divided before that time.

The young fry.—After the fry hatch out they will require but little attention until the yolk sac is absorbed and the time of feeding comes on. They should be examined each day, and the dead fish and other decayed matter removed from the troughs. The troughs should be kept perfectly clean and provided with a thin layer of coarse white sand on the bottom, which will serve in keeping the fish clean and in a healthy condition. As the fish grow they should be thinned out in the troughs from time to time, as their size may require. When they first begin to feed, 12,000 to 15,000 fish to the trough will not be too many; but by the time they get to be $1\frac{1}{4}$ to $1\frac{1}{2}$ inches long they should be divided up, 8,000 to 10,000 to the trough, while with yearling fish, or fish averaging 3 inches in length, from 3,000 to 4,000 will be as many as one trough will carry. More room would be advisable in all cases if it is to be had.

Food of young trout.—Beef or sheep liver, ground or chopped to a fine pulp, is generally recognized as being the best artificial food for young trout. Other things have been tried, such as hard-boiled eggs grated fine, milk curds, etc., but liver seems to be the favorite article at present. Some efforts have been made to produce a natural or living food, but the results so far, I believe, have been unsatisfactory. This may yet be accomplished for late spring and summer feeding, but for feeding the fry during the first three or four months of their lives, which is in the winter season, I think we will have to be contented with something besides a living food, and for this purpose I can recommend nothing superior to the liver diet, unless it be fish eggs.

Fish eggs as food.—During the spring of 1895 the idea was conceived of having shad and herring roe put up in tin cans to serve as food for young trout. One case (2 dozen 1-pint cans) was sent to me at Wytheville Station, but as I did not receive it until the first part of June, and my fish were then all good-sized fingerlings, I was not successful in getting them to eat it at that time, as they seemed to be looking for something larger than herring roe. I concluded then that I would keep over a few cans and try it the following season (1895-96), while the fish were yet small. This I have now done, and the result has been very satisfactory. I am sorry that I did not have enough roe this season to prosecute the experiment further; but my experience has been sufficient to convince me of its merits and to cause me to believe that it is a more wholesome diet for young trout than liver, since it does not pollute the water in feeding and the fish grow to be extremely fond of it. I am of the opinion that fish roe will hereafter form a good part of the food for young trout that are reared in confinement. I understand that it can be gotten during the fishing season in large quantities.

Feeding the fry.—In my opinion the feeding of young fry is the main point in successful trout-breeding and the part in which we are most likely to err. I believe that more young trout die from improper feeding than from all other causes put together; and the reason for it consists in too much haste in feeding or else in distributing

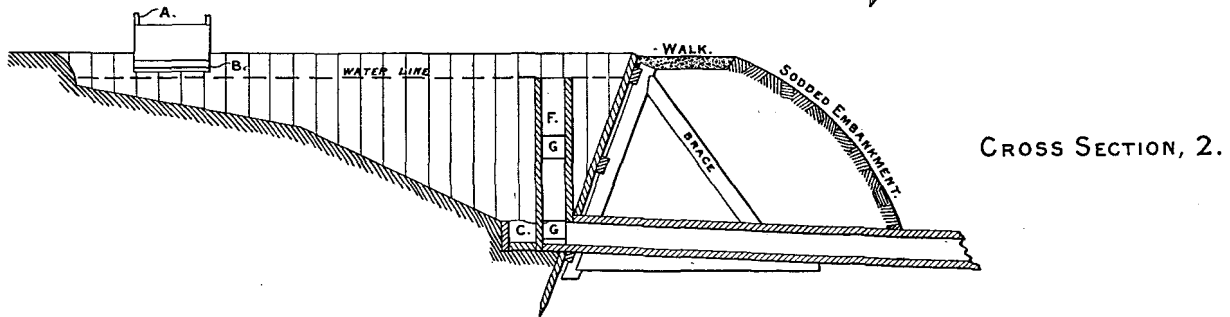
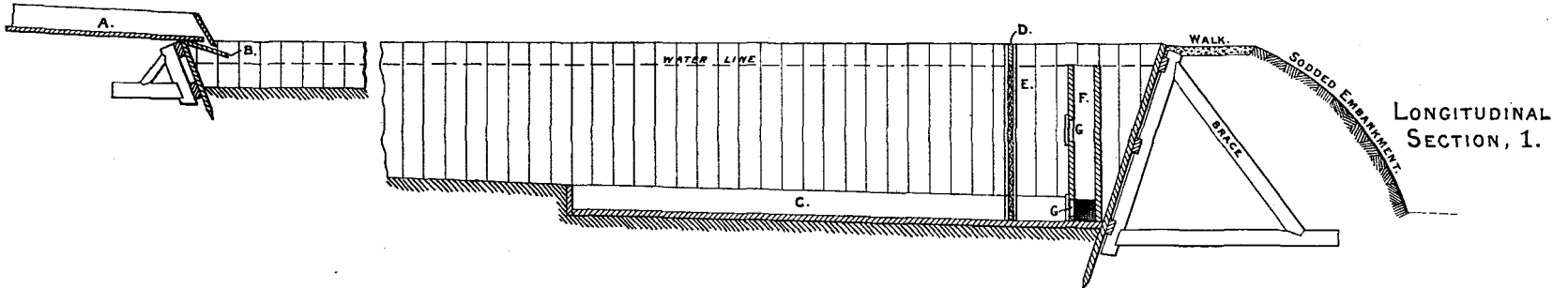
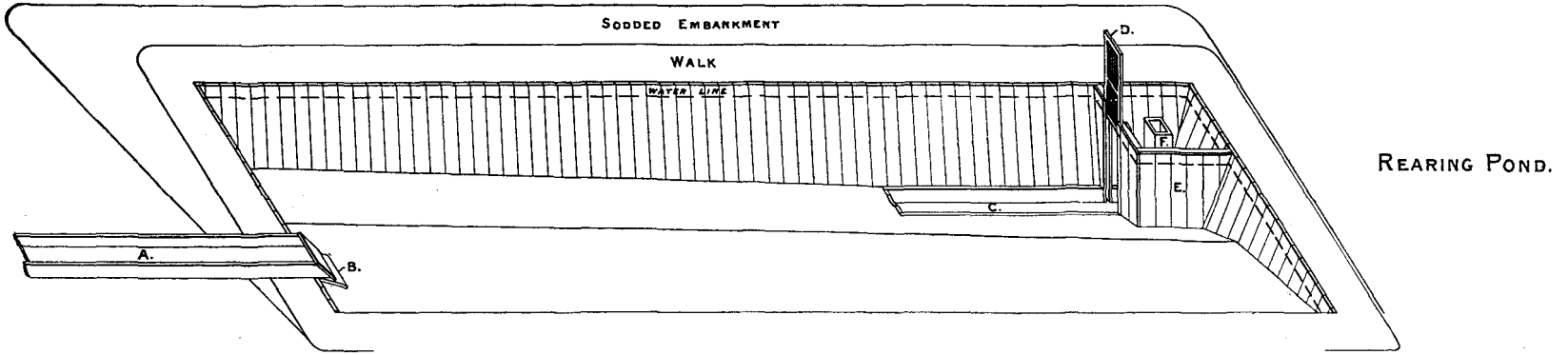

- A. Supply trough.
- B. Apron.
- C. Receiving trough.
- D. Guard screen.
- E. Crib around standpipe.
- F. Standpipe.
- G. Holes in standpipe.

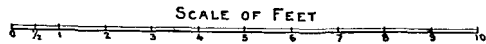

REARING POND.

the food in such manner as to prevent each one from getting its proper share. If liver is used as food it is very difficult to distribute it evenly through the water so that all the fish will partake of it without the water in the trough being made milky from its use. This is very objectionable and, in my opinion, very injurious to the young fish. I think that it produces inflammation of the gills and a slimy, itching disease of the skin, often causing heavy mortality among the young fish. The fry will be ready to take food as soon as the yolk sac is absorbed; the time required for this will depend upon the growth of the fish, superinduced by the temperature of the water. At Wytheville, where the water temperature is regular at 53°, they will take food in about 30 days after hatching. The time to commence feeding can be closely determined by watching the movements of the fish. Before the yolk sac is entirely absorbed they begin to break up the schools on the bottom of the trough and scatter through the water, rising higher and higher from the bottom of the trough each day until they can balance themselves gracefully in a horizontal position, all heading against the current and swimming well up in the water. They are then apt to be ready for food, but, to make sure of it, drop some small bits of cork or a nap from red flannel on the surface of the water, and if they strike at it as the current carries it down, give them food, but do not give it to them until they strike at the substance floating.

Their food should be prepared very fine, and if it consists of liver it will be found necessary to put some water with it before feeding, in order to make it distribute evenly. The liver can best be given to the fish with a feather, by dipping the feather into the liver and skimming it over the surface of the water in the trough. After the fish grow to be $1\frac{1}{4}$ to $1\frac{1}{2}$ inches in length they will begin to take the food that settles on the bottom of the trough, and as it is then not so tedious and difficult to feed them the food can be given from the hand and it will not be necessary to mix it with water. The young fry should be fed five or six times a day, giving them their food slowly and sparingly. After they learn to take their food well from the bottom of the trough three feeds a day will be sufficient, as they can then be given more at each feeding.

The rearing ponds.—Ponds for rearing fish should be narrow, say from 8 to 12 feet wide, and any desired length, up to 60 feet. For convenience in drawing off the ponds, etc., I would not advise making them more than 60 feet long. The size, shape, and arrangement of the ponds must depend altogether upon the topography of the ground where they are to be constructed. If it can be so arranged, I prefer to have these ponds built on a hill-side, one pond above the other, with earth and piling embankments at the lower sides and at the ends. A pond of this kind is shown at plate 91, and is the one which I shall endeavor to describe. In the construction of these ponds various materials may be used for damming the water. The embankments may be made of earth altogether, or they may be lined on the inside next to the water with stone, brick, cement, or timber. In all cases they are constructed with the same end in view, and the general principle is very much the same. It is not always convenient to use certain materials, but where the ground is of a porous or loose formation it will be necessary to use piling or cement for the inside of the embankments, and possibly cement for the bottoms.

I prefer in all cases to have earth bottoms, where the nature of the ground will permit. The water should enter the pond at one end and discharge from the corner having the deepest water in the opposite end. The bottom should be graded as shown in the cross-section 2, plate 91, and with a slope toward the outlet, so that all the

water can be drawn out, and in doing so the fish will be drawn into the receiving trough (C), which is placed with its top flush with the earth bottom in that part of the pond. The outlet for the water is an L-shaped pipe (shown at F, in cross-section 2), which is placed in the corner of the pond, the long end passing through the piling and underneath the pond embankment; the short end, called the stand-pipe, stands close in the inside corner of the pond in an upright position. The stand-pipe should have two or more holes cut through (G, in section 1, plate 91) on the side next to the receiving-trough, for the water to pass out in drawing down the pond. The size of these holes should be made in proportion to the size of the stand-pipe, which in turn should be governed by the size of the pond. The holes are to have a block of suitable size tacked over them to allow the pond to fill with water. A crib should be built around the stand-pipe, as shown at E. In the front of this crib is placed the guard-screen (D), which should be 15 inches or more in front of the stand-pipe.

The guard-screen should be from 14 to 16 inches wide, using wire cloth 2 inches narrower. The wire used on the screen should either be of copper or well galvanized. The size of the mesh in the wire should be suited to the size of the fish in the pond. The receiving-trough (C) should also be in proportion to the size of the pond. For a pond 10 by 40 feet a receiving trough 16 inches wide, 6 inches deep, and 10 feet long would be a good size. A portion of the trough, as wide as the guard-screen, should extend back and connect with the stand-pipe, the guard screen to fit down on the inside of the trough. If the work is well done this will make every part secure, and there will be no danger of losing fish in drawing the pond. The trough or pipe carrying the water into the pond must be so arranged that the fish can not jump from the pond into it. A good plan is shown at A, in the longitudinal section (plate 91); also at A, in rearing pond. This arrangement has been in use at Wytheville Station for a number of years and has given entire satisfaction.

Stocking the rearing-ponds.—In stocking the rearing-ponds with trout fry I would strongly recommend doing it by degrees, especially where the feeding is to be done by hand. I would put 500 to 1,000 fish in the pond and train them to take food readily before adding to them; that number of fish can generally find enough natural food in the pond to subsist upon until they can be trained to take the food that is given to them. Then add another 1,000 fish, and in about 10 days 2,000 more may be added, and so on till the pond is stocked with the desired number. When fish are first released in the ponds they seem to be wild, and will run away from the food given to them; hence the necessity of teaching a few fish to eat first and then to add more from time to time. The first lot of fish being trained to eat, others will soon follow.

The number of fish that a pond of a given size will support will depend upon the amount and temperature of the water and the amount of shade furnished, etc. In a pond 10 by 50 feet, and with water from 3 inches to 3 feet deep, I would not put over 10,000 fish in any case, unless I was forced to do so for want of room.

Packing eggs for shipment.—In packing trout eggs for shipment, they are usually placed on trays in wet moss. At the Wytheville Station, whence shipments are made to all parts of the United States and to many foreign countries also, the eggs are packed as follows: The number to be shipped is divided in from five to ten equal parts, according to the size of the shipment. If 30,000 eggs are to be shipped, I would use 10 trays large enough to contain 3,000 eggs each; if 15,000 eggs, I would have 10 trays containing 1,500 eggs each; 10,000 eggs, 8 trays of 1,250 each, etc. If over

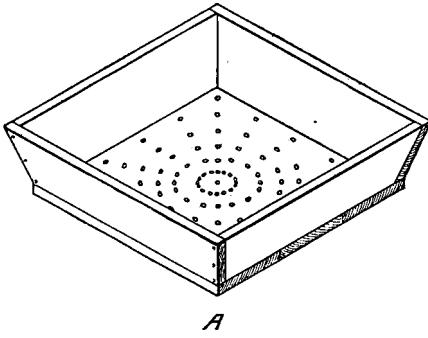

A

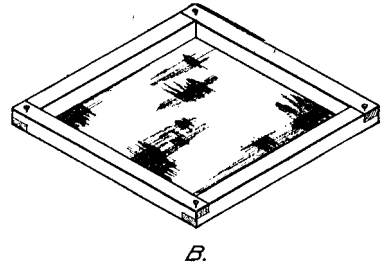

B

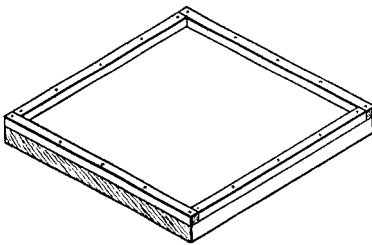

C

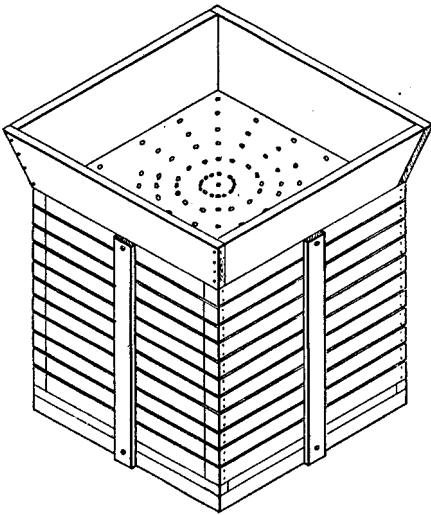

D

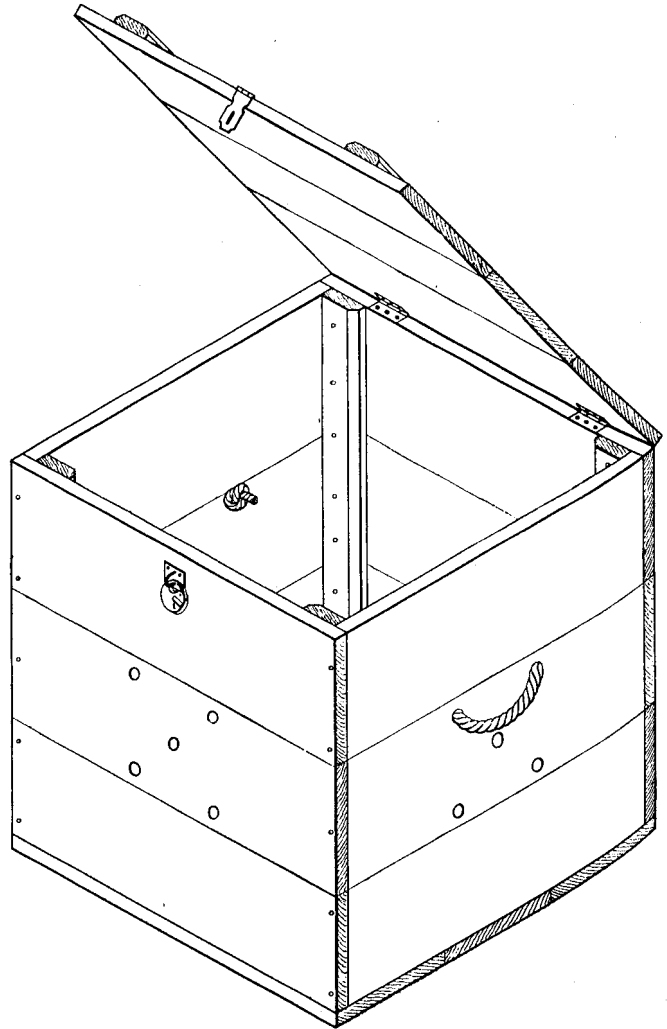

E

- A. Ice hopper.
- B. Egg tray.
- C. Foundation board.
- D. Egg trays packed and cleated.
- E. Outside case.



[The scale of this figure also applies to figs. A, B, C, and D.]

30,000 eggs are to be shipped, I would divide the shipment in two lots and send two boxes. A package of more than 10 trays, especially if the trays are large, would be liable to crush the eggs on the lower trays by having too much weight above. If less than 5 trays are used in a shipment, the package is apt to dry out, and the eggs will reach their destination either dead or in a shriveled condition. The frames of the trays (B, plate 92) are made of light, soft lumber, dressed to $\frac{5}{8}$ by $\frac{7}{8}$ of an inch, and are bottomed with soft canton flannel stretched on tight and well tacked. The trays are made large enough not only to contain their proportional part of the number of eggs to be shipped in one layer deep, but allowance is made for a space of $\frac{3}{4}$ of an inch between the eggs and the frame of the tray.

A foundation board (C, plate 92) is made with outside dimensions same as the egg tray, and with a strip nailed around the edge on the top side to form a cushion of moss

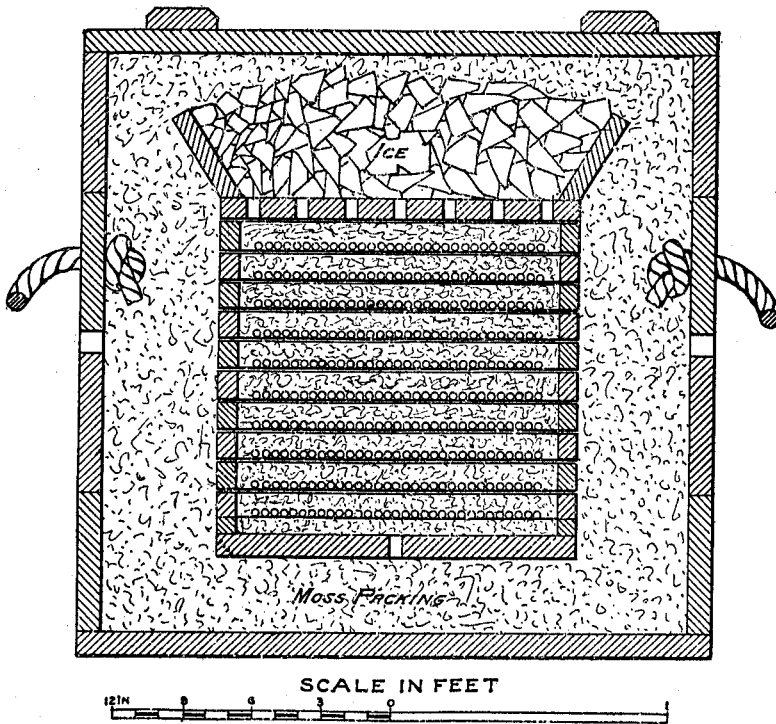

FIG. 4. Cross section through box after it has been packed and closed.

for the bottom tray. The hopper (A, plate 92) is used on the top tray. The outside case (E, plate 92) is made 7 to 8 inches larger on the sides (inside measure), and 5 inches deeper than the outside dimensions of all the crates after they are cleated together, including hopper and foundation board, as shown at D (plate 92). The trays having been thus prepared, the eggs are selected for shipment (those showing eye-spots and not too old to reach their destination before time for hatching out, making allowance for changes in temperature which they are liable to undergo on the road, causing them to hatch sooner than if left on the hatching-trays). They are taken up from the hatching-trays in pans, and after cleaning them well of all sediment, etc., and giving them a slight concussion, which can be best done by allowing water to fall on them from a

small spout or sprinkling pot, they are closely picked over, removing all dead and unfertilized eggs, which will nearly all turn white after the concussion is given.

The eyed eggs are then measured or weighed (we use apothecary scales, weigh 1 ounce and count them, or count the eggs for one tray and weigh them) and placed on the trays, the required number to each tray, and in a single layer in the middle of the tray, leaving all the empty space on the outsides next to the frame. They are then placed on the foundation board, one at a time; the eggs are covered with a piece of mosquito netting, which should be at least 2 inches larger each way than the egg trays; then the tray is filled with wet moss, the part immediately over the eggs in a loose manner, and the empty space around the eggs packed tight. This will help support the next tray above and also prevent the eggs from coming in contact with the wood and becoming dry and shriveled. After the trays are all packed and placed one upon the other, the hopper is placed on top, and the whole cleated together, as shown at D (plate 92). The crate is now ready to be placed in the box or outside case (E, plate 92). Put dry sphagnum moss, or the material to be used in packing, in the bottom of the box to the depth of 3 inches, then set in the crate of eggs, placing it as near in the center of the box as possible, pack the sides well to hold the crate in the proper position, and when the top of the hopper is reached with the packing, fill the hopper well with ice, then finish filling up the box with moss. Never use wet moss, or wet packing of any kind, for the cushion around the egg crate; it will not preserve as even a temperature and it will be liable to freeze solid if exposed to a low temperature in transit. After the box has been packed and closed, if it should be cut through the center, it would present an appearance like fig. 4, p. 251.

Amount of water necessary for incubation of eggs and rearing of the fishes.—The amount of water necessary in any case will depend upon the temperature of the water and the manner in which it is applied. The water should receive as much aeration as possible before entering the compartments containing the fish or eggs. At the Wytheville Station, where we have an even temperature of 53 degrees in the hatchery, we use in the troughs containing fish and eggs about the following quantities:

- 100,000 eggs during incubation, 12½ gallons per minute.
- 100,000 fish hatching to time of feeding, 30 gallons per minute.
- 100,000 fish from 1 to 4 months old, 50 gallons per minute.
- 100,000 fish from 4 to 6 months old, 100 gallons per minute.
- 100,000 fish from 6 to 12 months old, 200 gallons per minute.

These amounts are ample; less would do; probably half would suffice if it were necessary to economize in the use of water. In rearing-ponds more water is required, as the circulation is not so good and the outdoor exposure will cause the temperature to rise. If water is plentiful I would double the amounts stated above for pond-culture.

Diseases of trout fry and remedies to be applied.—The most common diseases of trout fry are the inflammation of their gills and a slimy and itching skin disease, both of which I believe are chiefly caused by impure water. The diseases may be caused by muddy water or from the foul and milky water produced in feeding the fish, especially if stale liver is used as food. The food itself may also produce it, but I think it generally comes from the fouling of the water. As an ounce of prevention is worth a pound of cure, the best plan is to prevent, if possible, the diseases by keeping the water pure. By watching the movements of the fish one can generally detect the symptoms of the diseases before they reach an alarming stage. If the



TROUT-REARING PONDS, TATES RUN, AND CARP PONDS TO THE RIGHT—VIEW OF TROUT-REARING PONDS, TATES RUN, AND CARP PONDS TO THE RIGHT.

gills are affected, the fish will usually swim high in the water, and in an uneasy restless manner, as if gasping for breath. When this is observed the gills should be examined to see if they are becoming inflamed and swollen. If the fish are taking a skin disease, they will generally indicate it by rubbing themselves on the bottom of the trough or against anything that may be convenient. They will dive down and give themselves a quick twisting motion against the bottom of the trough, as if they were trying to scratch a place that was itching. If the progress of the disease is not promptly checked it will soon be at a stage when nothing can be done, and the fish will grow weaker every day until they begin to die in alarming numbers.

The best remedy for both diseases that I know of is salt. Draw the water low on the fish and apply it freely by sprinkling it evenly through the water. If it is a bad case of skin disease I would use a half pint of salt for each gallon of water in the trough, or about that proportion. Watch the fish closely, and let them remain in the salt water until they get restless and begin to turn on their sides; then turn on fresh water, and as the trough fills you will have the satisfaction of seeing the slime rise and float on top of the water, like a white scum. Coarse sand should be kept in the trough for the fish to scratch themselves against. Salt will also be good for the diseased gills; it will free them of all sediment, etc., that is sure to adhere to them. Fungus, "blue swelling," etc., sometimes occur, but I have never had any serious trouble with any diseases of the fry except the two first named. Parasites will sometimes attack the fish, but if the water is pure and the fish are in a healthy condition, I hardly think the parasites will give much trouble. To keep the fish that are reared in troughs and tanks in a healthy condition, I think it is well to give them a salt bath occasionally. A little salt in their food will not hurt them, and it sometimes seems to do them good. I consider a little sediment from the reservoir, or such as collects on stones, etc., in the streams, a good preventive of disease, if mixed with their food; it is only natural that they should have something of that kind, since all, or nearly all, of their natural food contains more or less of it.

Diseases of the adult trout.—A very serious disease, for which I know no name, shows the following symptoms: The afflicted fish refuse to take food, and very dark spots, from $\frac{1}{4}$ to 1 inch in diameter, appear on different parts of the body. These spots vary in number from 2 or 3 up to 25 or 30 on each fish affected. A light spot about the size of a green pea appears on the head immediately over the brain. The fish are generally restless; some will seek the shallow water in the corners of the pond or else hide away among the plants, if there be any in the pond accessible to them. Within 24 hours from the time the disease is noticeable the fish begin to die. They will jump and dart around in the water, as if crazy, and then settle back on their tails and sink to the bottom of the pond in their last struggle for life. Almost by the time they reach the bottom they are dead and stiff. This disease made its appearance at the Wytheville Station in December, 1895. It was first observed among a lot of 637 yearling Von Behr or brown trout that had been delivered to the station on November 29 by one of the United States Fish Commission transporting cars. The first sign of this disease was noted about the 5th of December, and by the 12th of the month 455 of the 637 fish were dead. These fish being in the nursery during the first stages of the disease, the water passed from them through an empty pond into a second one containing about 1,000 large rainbow trout that had recently been stripped of their spawn. On the morning of December 23, this dreadful disease made its appearance

among the latter, and by 4 o'clock in the evening of the same day 56 of them had died. Salt was the first remedy decided upon; so the water in the pond was drawn down to about 300 gallons or probably a little more, and 150 pounds of common salt were sprinkled evenly through it. The fish were allowed to remain in this brine about 15 minutes, when they showed signs of weakening by turning on their sides; then fresh water was turned on freely. The good result was at once noticeable, the fish becoming quiet, and appearing to rest more easily. It was my intention to give them another salting two days later, but as they were steadily improving I concluded that another application was unnecessary. The final result was that 70 per cent of the adult rainbows that had been treated with salt were saved, while of the yearling brown trout, that were not thus treated, nearly 71½ per cent died.

Foul ponds are dangerous, and will produce disease if not attended to. If the fish get sick from this cause, they should be removed to a clean pond at once; give them a salt-and-clay bath, and then turn on an increased amount of fresh water for ten days or more following.

The adult fish are very liable to be affected with fungus. It generally comes after a bruise or hurt, or when the fish is in an emaciated condition. If the trouble results from an injury, it can often be cured before it spreads to the sound flesh; but if fungus spreads like a slimy web all over the fish, it is sure death. Just after spawning, they are especially susceptible to fungus. They should be handled very carefully during the spawning season to prevent the moving of a scale or scarifying the body in any way, either of which would be almost sure to be followed by fungus. If there is any hope of saving the fish, it should be treated at once, and I do not know of a better remedy than salt. Catch the fish and rub the salt on the affected part, and then release it in a pond, or tank, by itself, where it can be gotten for treatment in a day or two again. The fish that are affected all over the body should be killed and thrown out at once, as there is no chance to save them.

I have given in the preceding pages such practical information as I could in reference to the artificial propagation of the rainbow trout, and hope that it may prove of value to those interested in such subjects. The results that have followed our efforts in an endeavor to stock various streams in many different localities of our common country with this gamy and delicious fish, beloved alike by epicure and angler, have in most instances proved successful and have demonstrated the practicability of varying and increasing our food supply, and at the same time providing another source of amusement and recreation for all the votaries of rod and reel.

CORRESPONDENCE RELATIVE TO THE RAINBOW TROUT.

The following extracts from letters of correspondents may prove interesting as showing the experience of fish-culturists in different portions of the United States:

[From W. D. Noel, of Lebanon, Mo., April 7, 1896.]

The United States Fish Commission planted, about 12 years ago, rainbow trout in Bennett's spring, which flows into Neaugua River about a mile from the spring, making a stream from 100 to 200 feet wide and from 1 to 3 feet deep. They have increased to a wonderful extent in the spring branch, and to quite an extent in Neaugua River. They have been caught 8 miles above and 25 miles below the mouth of the branch. They are the gamest fish we have and are exceedingly shy. They take the fly here better than any bait. As for eating qualities I do not think it equaled by any fresh-water fish.

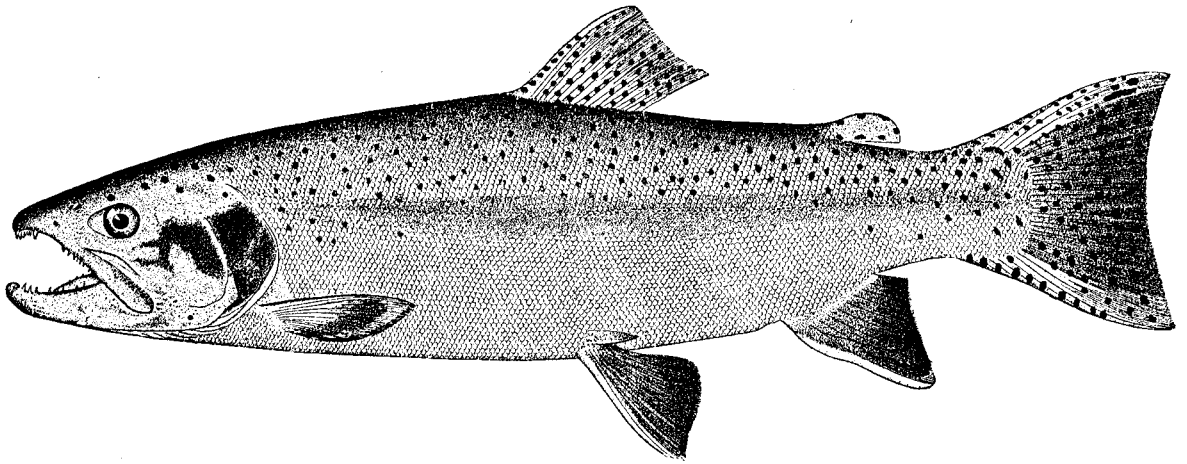

THE RAINBOW TROUT (*Salmo irideus*). Adult male.

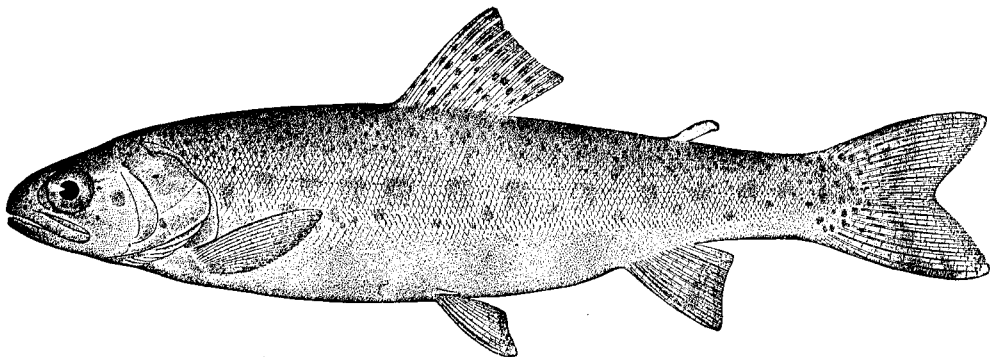

THE RAINBOW TROUT (*Salmo irideus*). Young.

[From Livingston Stone, superintendent of United States Fish Commission Station, Baird, Cal., December 27, 1895.]

Here in the McCloud River the rainbows spawn from February to May, inclusive, and in confinement the spawning season seems to begin a month earlier than in the river. They have no average size, strictly speaking, as they are found here of sizes up to and slightly exceeding 10 pounds in weight. They are found in most mountain streams about here, and are usually quite abundant where they occur at all and have not been fished out. They rank well up as a game fish, but as a pan fish they are very much inferior to *fontinalis*, though when properly cooked they are very palatable. The temperature of the McCloud varies from about 38° at this season to 63° in July. The fly fishing is best in the spring and early summer in this part of the river.

[From M. C. Toms, Hendersonville, N. C., February 6, 1896.]

About ten years ago a small lot of young fish were placed in Green River in this county, of which nothing was known until two years afterwards, and we supposed they were lost, but after two years you could occasionally hear of one being caught. A year after this a friend of mine and myself rigged up our rods and started for this beautiful stream. We soon had our tackle in good trim and were casting our hooks far down the stream, when, to my surprise, I found that one had my hook and was making off with it. It was fine sport to reel him up the swift water, and I found it to be a 3-pounder, glowing in the sun, with his beautiful rainbow colors. No fish could look gamier. They are doing well and the river is well stocked with the little ones. If our laws were more strict we would have plenty of these beauties. Through the Fish Commissioner at Washington I have stocked several other streams, but they have not as yet had time to show what they will do. I regard the rainbow as a good biter, but not as good a puller as the brook trout.

The work of stocking these streams by the Government is a step in the right direction, and will be a great source of food and pleasure for the future. One thousand yearling fish were planted in Green River from Wytheville Station by myself on February 1, 1888.

[From J. D. Phipps, Longs Gap, Grayson Co., Va., December 30, 1895.]

I will say in reference to the fish deposited in our stream, Peach Bottom Creek, that they have grown and propagated as fast as any fish I ever saw; in fact much faster than the mountain trout. We posted the stream and allowed no fishing for four years. Now our stream is full of the finest trout. I have caught them 22 inches long. Their flavor is fine, and they are the most gamy fish I ever saw. Their rapid increase has kept the stream well supplied ever since.

[From F. N. Clark, superintendent of United States Fish Commission Station, Northville, Mich., January 23, 1896.]

The Au Sable River was first planted with rainbow trout about 17 or 18 years ago, I think, from eggs forwarded from the collecting station in California to the Michigan Fish Commission, hatched at their hatchery, and planted by them. Since that time there have been several plants made at different times, but not in large numbers. The success of this river is probably the most marked of any of the rivers of Michigan where rainbow trout have been planted. In certain portions of the river large rainbows are taken with hook and line, often weighing from 5 to 7 pounds, and in our net fishing for brook trout during October, 1895, the trout caught would run about one-third rainbow; in addition to this we would catch from 100 to 1,000 last spring's hatch, and they would run a larger number rainbow than brook trout. The rainbow caught in the Au Sable are considered by sportsmen as more gamy than either the brook trout or graylings, and it requires heavier tackle for this fish than for a brook trout of equal weight. Rainbow trout are also taken quite frequently with hook and line in Pere Marquette River, also the branches of that stream.

[From R. W. Requa, of the California State Fish Commission, Sisson, Cal., January 31, 1895.]

The waters of this State are well stocked with the different species of trout, and the fishermen all agree that the rainbow is the king of trout, its game qualities being greater than the others. The only exception to this statement is the *Salmo mykiss* of Webber Lake, Sierra County, which is noted for its game qualities. As a food-fish the rainbow is far superior to any of the trouts found in the mountain streams of this State. Those in the headwaters of streams usually have white flesh, while in those found near tide water the pink color is found. The feeding-grounds are a great factor in making up the color and flavor. Much has been said and written as to the size of the rainbow trout of California, and I find that the reports do not agree. At our spawning station on the Klamath River, in Siskiyou County, we found the average size to be as follows: First run, 5 pounds; second

run, 4 to 4½ pounds. Very few rainbows weighing as high as 8 pounds are caught. Those from the McCloud River, a tributary to the upper Sacramento, are the finest flavored fish found on the Pacific Coast. They do not exceed 2 to 3 pounds in weight; the average would be about 1½ to 2 pounds.

[From W. K. Hancock, foreman at United States Fish Commission Station, Leadville, Colo., January 22, 1896.]

In the streams throughout this part of the country the rainbow trout are not very plentiful, and their average size would probably be from three to five fish to the pound, but occasionally one will be taken weighing one-half to three-fourths of a pound. Their growth is very slow in our streams and small ponds in this immediate vicinity. In the lower parts of the State, south and southwest of this place, they are more plentiful, and grow much larger. In Twin Lakes, 12 miles southwest of here, they grow to 12 and 13 pounds. We have caught them 25 to 28 inches long, and weighing from 8 to 13 pounds. They are very game, and are considered fine served on the table.

[From Gustave Schnitger, State Fish Commissioner of Wyoming, October 25, 1895.]

Regarding the rainbow trout, I would say the first plant of young rainbow trout made in the Laramie River in this State was by Hon. Otto Gramm, of this commission, the eyed ova of the *Salmo irideus* being sent to him in the year 1885 by Livingston Stone, of McCloud River Station. At that time 10,000 eggs were shipped; also in 1886 there were 20,000 rainbow trout eggs sent; fry of same were planted in the Big Laramie River. Since then most of the rainbow trout raised at the hatchery, and the young trout from eggs from Neosho, Mo., are planted in Big and Little Laramie rivers and in the upper waters of North Platte River. All of these streams are excellent for these fish or, in fact, for any of the trout so far introduced. Some of the rainbow trout taken are reported as weighing as much as 9 pounds. They are truly a fine food-fish, as well as an excellent fish for anglers.

[From T. W. Scott, Rome, Ga., December 17, 1895.]

I have only fished in Raccoon Pond, the place where the rainbows were planted, two evenings since they were put there, and each evening I caught some trout; they were from 8 to 10 inches long and very game. The year after they were put there the dam broke and a great many of them escaped. I have been told by parties living near the stream, and who fish a good deal in it, that they have caught quite a number of them below in the creek, and some where the creek empties into Chattooga River. They are all about the same size, from 8 to 10 inches long. Those planted in Silver Creek are also doing nicely, from the reports from that place.

[From A. H. Gibboney, Marion, Va., July 29, 1892.]

In Holston River, where Staley Creek empties into it, this morning, Mr. Coalson, of this place, with hook and line, caught a California or rainbow trout 24 inches long and weighing 6½ pounds. Have you ever known one to weigh so much? I got this information from Dr. Ed. Haller, who saw Mr. Venable weigh it. It was also weighed by J. E. Waldrup. It was almost ready to spawn.

[From W. T. Dennis, commissioner of fisheries of Indiana, Richmond, Ind., July 23, 1889.]

I have just returned from a visit to Tippecanoe River, at Monticello, and am happy to say that the plant of rainbow trout made there at the request of Mr. Gregory seems to have proven a gratifying success. They may be seen almost every fair evening, as the shadows creep over the water, jumping for flies and in such numbers as to prove them numerous and healthy.

[From William W. Finney, cashier of the Harford National Bank, Belair, Md., April 26, 1895.]

Several years ago I got a lot of rainbow trout from your station to stock two streams that flow into Deer Creek, a tributary of the Susquehanna River. They came in good order, and I dumped them in, and they never seemed to amount to anything. Now and then you would see an occasional trout, and then you would not see any, but the other day I was examining one of the streams and was surprised to find a good many nice-looking fellows, about 4 or 5 inches long, and here and there a big fellow. It looks like they were beginning to get a start. I was afraid the stream did not suit them and that they had cleared out.

[From J. D. Huntoon, M. D., of Lowell, Mass., November 8, 1892.]

The rainbow trout sent me last season are now growing finely. I think I saved about 400 of them and put them in a spring brook, with some small ponds in its source, and have watched them closely. I hoped the larger ones would spawn this fall, but can not find any indication of it. I think them very hardy and desirable.