

# Organizing the Technical Article

UNITED STATES DEPARTMENT OF THE INTERIOR  
FISH AND WILDLIFE SERVICE  
BUREAU OF COMMERCIAL FISHERIES

Circular 269

UNITED STATES DEPARTMENT OF THE INTERIOR

Stewart L. Udall, *Secretary*

David S. Black, *Under Secretary*

Stanley A. Cain, *Assistant Secretary for Fish and Wildlife and Parks*

FISH AND WILDLIFE SERVICE, Clarence F. Pautzke, *Commissioner*

BUREAU OF COMMERCIAL FISHERIES, H. E. Crowther, *Director*

# Organizing the Technical Article

By

F. BRUCE SANFORD

Circular 269

Washington, D.C.

March 1968

## CONTENTS

	Page
Introduction . . . . .	1
Deductive method of outline formation . . . . .	3
A. Achieving correct coordination . . . . .	3
1. Coverage . . . . .	4
2. Sequence . . . . .	5
B. Achieving correct subordination . . . . .	6
1. Helping others . . . . .	6
a. Finding the error of faulty subordination . . . . .	6
(1) What to look for . . . . .	6
(a) Singly occurring errors . . . . .	6
(b) Multiply occurring errors . . . . .	7
(2) How to look . . . . .	8
(a) Looking for suspiciously large numbers of topics . . . . .	9
(b) Looking for special relations . . . . .	10
b. Correcting the error of faulty subordination . . . . .	11
2. Helping ourselves . . . . .	12
a. Choosing the correct number of coordinate topics . . . . .	12
(1) When the correct number is only one . . . . .	12
(2) When the correct number is more than one . . . . .	14
(a) Two topics . . . . .	14
(b) Three or more topics . . . . .	15
b. Choosing the correct size of coordinate topics . . . . .	16
Inductive method of outline formation . . . . .	17
A. Getting the ideas . . . . .	17
1. Listing . . . . .	17
2. Selecting . . . . .	17
a. Pertinent ideas . . . . .	18
b. "What" ideas . . . . .	19
B. Arranging the ideas into a pattern . . . . .	19
1. Separating the ideas according to outline level . . . . .	20
a. Placing the ideas in logical order . . . . .	20
b. Dividing the ideas into subgroups . . . . .	20
2. Synthesizing the missing ideas . . . . .	22
Summary . . . . .	24
Acknowledgment . . . . .	26
Appendix . . . . .	27

# Organizing the Technical Article

By

F. BRUCE SANFORD, Senior Scientific Editor

Bureau of Commercial Fisheries Branch of Reports  
U.S. Naval Air Station  
Seattle, Wash. 98115

## ABSTRACT

No article can be more efficient than the outline from which it is written. This manual presents a technique for devising an efficient outline by either deductive or inductive reasoning, whichever is more appropriate to the circumstances. The technique is based on strict adherence to the principles of logic.

## INTRODUCTION

Every scientist and engineer is confronted with more articles than he can read to keep abreast of his field. With such a heavily burdened reader, how can we hope to communicate our ideas to him? The surest way is for us to write our article so clearly that he can read it rapidly yet understand it completely.

To write such an article, we must start with a good outline. Forming the outline needed, however, is hard, for it must meet the requirements of logic. The purpose of this manual therefore is to suggest how we can make an outline that is logical.

In our study of the principles of outlining, we are handicapped

by the fact that outlines deal with entire articles. For that reason, illustrations of the principles take up much space. We can solve this problem, however, for we can use symbols instead of lengthy verbiage.

To make our symbolism meaningful by a specific example, let us suppose that our article is to have the title "Neahkahnne Mountain--A Naturalist's Paradise," and let us represent this overall topic by the symbol "Topic A." Now, let us divide our subject into the two main parts shown in figure 1A, and let us construct our symbolized outline to correspond (fig. 1B). Finally, let us expand the outline as shown

Neahkahnie Mountain--A Naturalist's Paradise

- I. Climate
- II. Life

Figure 1A.--Illustrative outline.

Topic A

- I. Topic AA
- II. Topic AB

Figure 1B.--Symbolized outline.

Topic A

- I. Topic AA
  - A. Topic AAA
  - B. Topic AAB
- II. Topic AB
  - A. Topic ABA
  - B. Topic ABB

Figure 2B.--Symbolized outline expanded.

in figure 2A, and again construct our symbolized outline (fig. 2B).

Neahkahnie Mountain--A Naturalist's Paradise

- I. Climate
  - A. On the land side
  - B. On the ocean side
- II. Life
  - A. Plant
  - B. Animal

Figure 2A.--Illustrative outline expanded.

Now that we have our symbolism in mind, let us convert the symbolized conventional outline into the corresponding branch-chain outline (fig. 3). But why do we need a branch-chain outline? For answer, note how clearly the branch-chain arrangement shows the relations among the topics.

When we study branch-chain outlines, we find two basic

methods of organizing ideas (fig. 4): deductive and inductive. In the deductive method, our ideas proceed from the general (or comprehensive) to the specific (or detailed). In the inductive, they proceed from the specific to the general.

Both methods of making an outline are valuable. If we start thinking about our subject in general terms, we use the deductive method. If we start thinking in terms of details, we use the inductive one.

Once we have made an inductive outline, however, we turn it end over to convert it into a deductive outline before starting to write. We always present our article to the reader in deductive form. Why? Deduction is easier than induction is.

In considering these two methods, let us look into the deductive method first, since we can treat the inductive method, though more complex, rather simply after we have given thought to the deductive one.

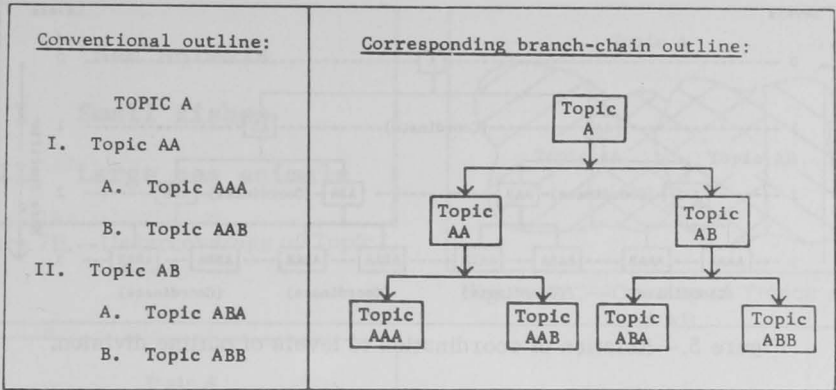

Figure 3.--Conventional outline and branch-chain outline.

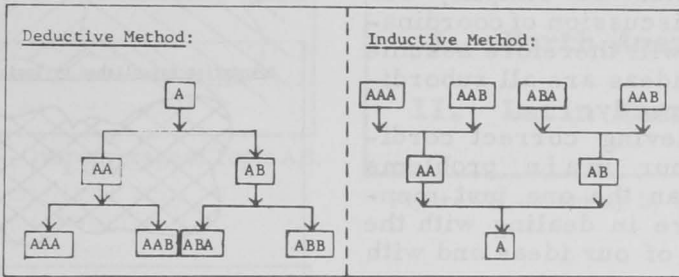

Figure 4.--Deductive and inductive methods.

## I. DEDUCTIVE METHOD OF OUTLINE FORMATION

When discussing the principles of outlining, we find need for the terms: "coordinate" and "subordinate." What do we mean by these commonly used terms? When we refer to coordinate, we mean that two or more closely related ideas are of the same degree of generality or specificity. In short, they are at the same level of outline division (fig. 5). By subordinate, we mean that one idea is less general--or alternatively, that it is more specific--than is another idea to which it is closely related.

For our outline to be logical, the coordination must be correct, and the subordination must

be correct. Unless these two conditions are met, the reader will not be able to follow our ideas rapidly when he reads our article. So our problem in making an outline is how to achieve correct coordination and correct subordination.

### A. ACHIEVING CORRECT COORDINATION

We can make certain mistakes in coordination without simultaneously making a mistake in subordination, but the converse is not true. For example, unless we have correctly subordinated our ideas, we will

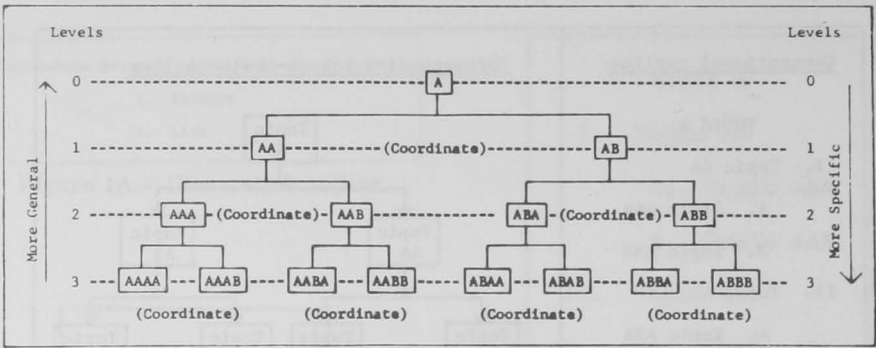

Figure 5.--Relation of coordination to levels of outline division.

erroneously present topics as coordinate that are actually subordinate. To simplify our present discussion of coordination, we will therefore assume that our ideas are all subordinated correctly.

In achieving correct coordination, our main problems (other than the one just mentioned) are in dealing with the coverage of our ideas and with their sequence.

### 1. Coverage

In figure 5, Topic AA + Topic AB = Topic A. In other words, the subject matter treated by coordinate subtopics must add up exactly to the subject matter promised by the superior topic (fig. 6). Thus, the coverage given Topic A by Topics AA and AB combined must be neither less (undercoverage, figs. 7A and 7B) nor more (overcoverage, figs. 8A and 8B) than the boundaries established by Topic A.

A special case of overcoverage might be called "overlap" (fig. 9A). In overlap, the same aspect of a subject is discussed in two or more sections of the paper (fig. 9B). This practice,

of course, is not logical. Each coordinate topic must be mutually exclusive.

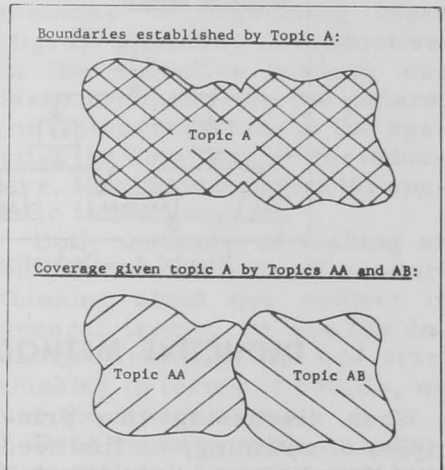

Figure 6.--Boundaries and coverage.

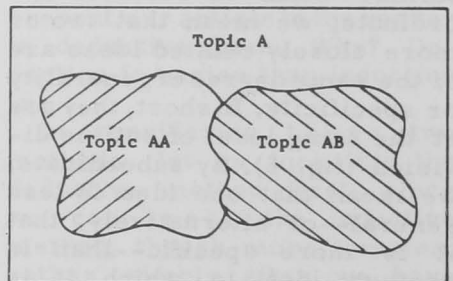

Figure 7A.--Undercoverage of Topic AA.

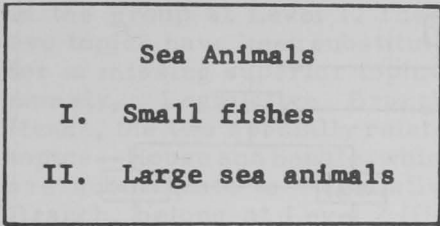

Figure 7B.--Undercoverage of Topic I.

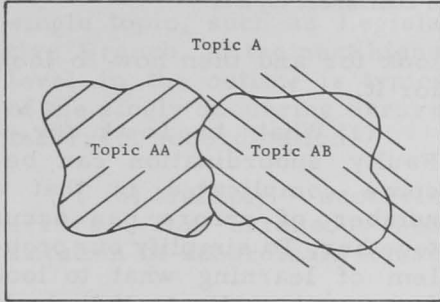

Figure 8A.--Overcoverage of Topic AB.

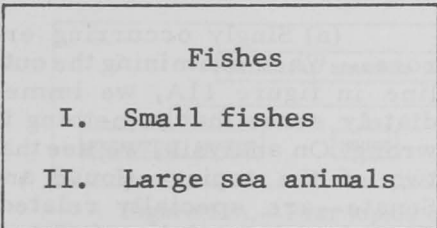

Figure 8B.--Overcoverage by Topic II.

## 2. Sequence

In considering how we can achieve correct coordination, we have seen that we must give attention to the coverage of our topics to ensure that we do not fall into errors either of undercoverage or of overcoverage. We turn next to the problem of sequence (fig. 10).

In the technical articles and books with which this manual is concerned, sequence is impor-

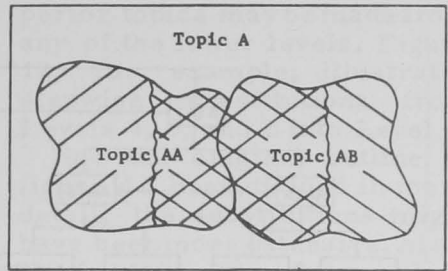

Figure 9A.--Overlap of Topics AA and AB.

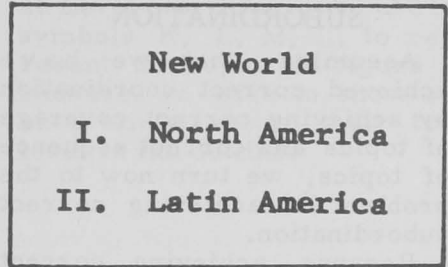

Figure 9B.--Overlap by Topic II.

tant. In a book on calculus, for example, presenting integral calculus before differential would be catastrophic for the student. Without a knowledge of differential calculus, he would lack the background necessary for him to understand integral calculus. Thus, in the articles and books of concern to us, the following equations normally hold true:

$$A = AA + AB \neq AB + AA$$

When presenting coordinate topics, we therefore make sure that we present them in optimum sequence. In short, we arrange them in such an order that after reading one coordinate topic in our series, the reader will have the background necessary for him to understand the next topic in our series.



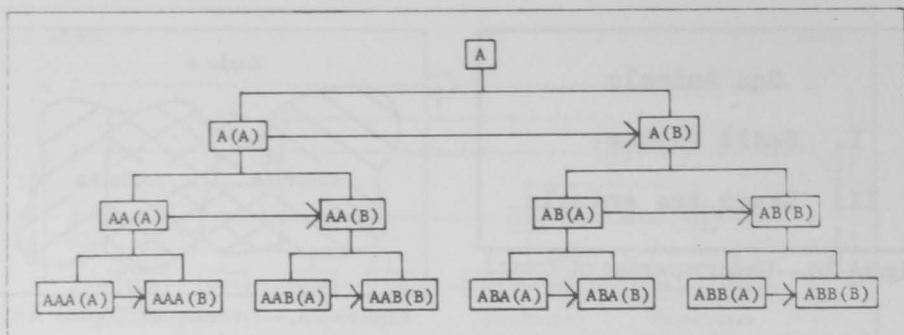

Figure 10.--Sequence of coordinate topics.

## B. ACHIEVING CORRECT SUBORDINATION

Assuming that we have achieved correct coordination by achieving correct coverage of topics and correct sequence of topics, we turn now to the problem of achieving correct subordination.

Because achieving correct subordination is hard, the error of faulty subordination occurs in the outline of nearly every article. Accordingly, it will likely occur in the outlines with which we are concerned unless we take special steps either to correct it or to avoid it.

Most of us who write technical articles also have the task of reviewing the writing of others. Let us therefore see how we can help other authors to correct the error of faulty subordination and then what steps we can take to avoid it in the articles that we ourselves write.

### 1. Helping Others

When we are helping others, our first problem is to find the error of faulty subordination, and our second problem is to correct it.

a. Finding the error of faulty subordination.--To find the error, we have to know what to

look for and then how to look for it.

(1) What to look for.--Faulty subordination can become complicated in that a number of errors can occur together. To simplify our problem of learning what to look for, we investigate the singly occurring errors before taking up the more complicated case of the errors that occur in multiple combination.

(a) Singly occurring errors.--When examining the outline in figure 11A, we immediately sense that something is wrong. On analysis, we see that two of the topics--House and Senate--are specially related. That is, the relation between the House and Senate is quite different, say, from the relation between the Executive Branch and the House. If the four topics--Executive Branch, House, Senate, and Judicial Branch--were all truly coordinate, special relations would not exist. The relations among them would all be equally close. The House, for example, would be related as closely to the Executive Branch as it is to the Senate.

Why then does this special relation exist between the House and Senate? They do not belong

in the group at Level 1. These two topics have been substituted for a missing superior topic--namely, Legislative Branch. Hence, the two specially related topics--House and Senate, which are subordinate to Legislative Branch, belong at Level 2 (fig. 11B).

The substitution of two or more subordinate topics, such as House and Senate, for a single topic, such as Legislative Branch, at the next higher level in the outline is typical of the singly occurring error of incorrect subordination.

(b) Multiply occurring errors.--The erroneous substitution of subordinate for su-

perior topics may be made from any of the lower levels. Figure 12, for example, illustrates stepwise substitutions from Levels 4, 3, and 2 into Level 1.

Had the original outline in figure 12 been divided in more detail, the substitutions might have been more extensive. Also, they might have taken place from levels lower than Level 4. Figure 13 illustrates the results of substitutions from an outline originally containing topics, at Level 5 or lower. We use the symbols K, L, M, ... to represent the topics in figure 13 because we wish to show our uncertainty as to their true level in the outline.

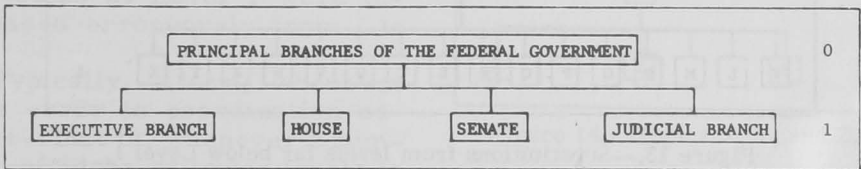

Figure 11A.--Four topics erroneously presented as coordinate.

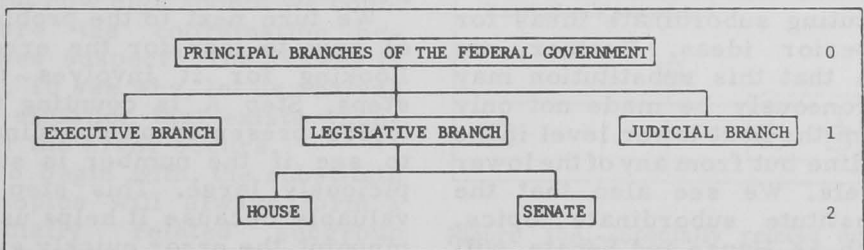

Figure 11B.--Correction of the error in coordination.

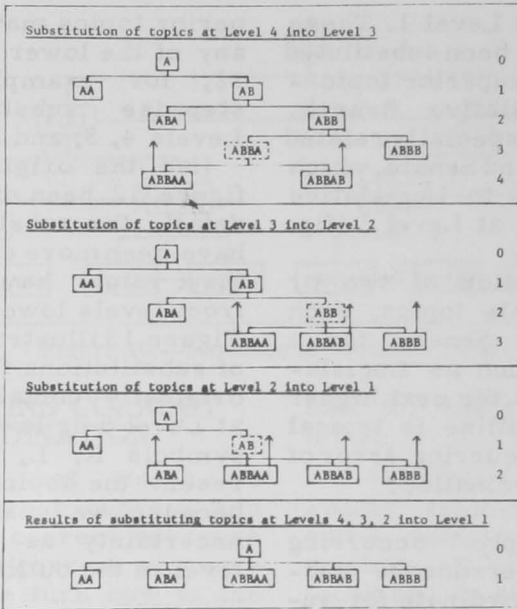

Figure 12.--Stepwise substitution of topics into Level 1.

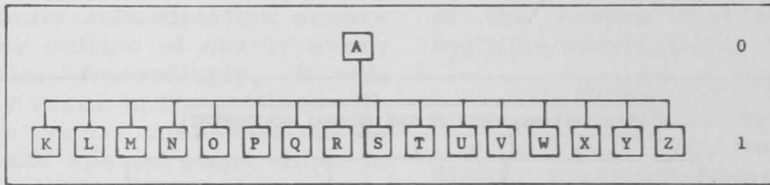

Figure 13.--Substitutions from levels far below Level 1.

(2) How to look.-- We have now gained an understanding of the nature of the error of incorrect subordination so that we know what to look for. We know that it can be singly occurring or multiply occurring. We see that it consists in substituting subordinate ideas for superior ideas. Further, we see that this substitution may erroneously be made not only from the next lower level in the outline but from any of the lower levels. We see also that the substitute subordinate topics, such as House and Senate, will form specially related sub-

groups among the superior topics. Finally, we see that, in general, the greater the number of lower levels from which substitutions are made, the greater the number of subordinate topics that will erroneously be presented as coordinate.

We turn next to the problem of how to look for the error. Looking for it involves two steps. Step A is counting the topics presented as coordinate to see if the number is suspiciously large. This step is valuable because it helps us to pinpoint the error quickly even when we are extremely busy.

Then, if counting indicates that the topics probably are not coordinate, Step B is searching for special relations among the topics, the presence of which proves that the subordination of ideas is faulty.

(a) Looking for suspiciously large numbers of topics.--In figure 11A, when House and Senate were substituted for Legislative Branch, the number of topics presented as coordinate was erroneously increased from three to four. In figure 12, when topics that should have been at Levels 4, 3, or 2 were substituted for Topic AB at Level 1, the number of topics presented as coordinate increased erroneously from two to five. In figure 13, when topics that should have been at Level 5 or lower were erroneously substituted for Topics AA and AB at Level 1, the number of topics at Level 1 were increased erroneously from 2 to 16.

Typically, then, whenever this error in coordination occurs--that is, whenever a number of ideas at lower levels in the outline are substituted for a single idea at a higher level--the result is inevitably an increase in the number of topics presented as coordinate. Thus, counting should give us a clue as to whether our topics are truly coordinate.

But how high should we count before the coordination becomes suspect? The answer is two. To see why, let us analyze the situation that exists whenever the error occurs.

To begin with, the substitute subtopics will always form a specially related subgroup (such as House and Senate in figure 11A). As an illustration,

let us consider three topics that supposedly are all immediately subordinate to Topic A. We will symbolize them as Topics X, Y, and Z both for generality and to indicate our uncertainty as to their true level in the outline (fig. 14). Unless Topic Y is in the exact center of thought between Topics X and Z, it will form a specially related subgroup with either Topic X and Topic Z, depending upon which topic it is more closely related to (fig. 15A).

Now, as we saw in the case of the House and Senate, whenever topics are specially related, the relation can be expressed by a more comprehensive idea (for example, Legislative Branch). Once we recognize what this more

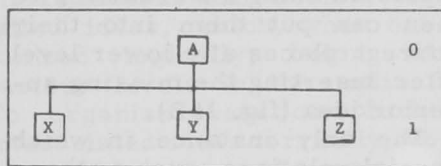

Figure 14.--Topics X, Y, and Z.

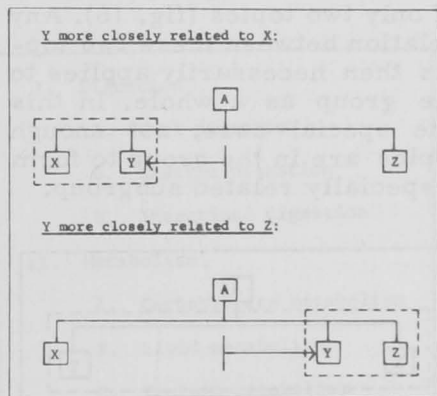

Figure 15A.--Specially related subgroups resulting when Y is displaced from the center of thought.

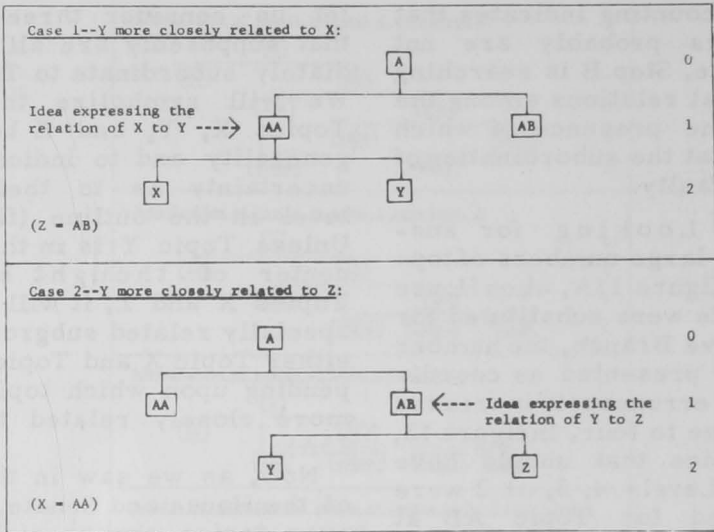

Figure 15B.--Insertion of missing superior idea.

comprehensive idea is, we can identify the specially related topics as being subordinate. We then can put them into their correct places at a lower level after inserting the missing superior idea (fig. 15B).

The only instance in which special relations, such as those represented by Cases 1 and 2 in figure 15A, cannot occur is when the entire group consists of only two topics (fig. 16). Any relation between these two topics then necessarily applies to the group as a whole. In this one special case, not enough topics are in the group to form a specially related subgroup.

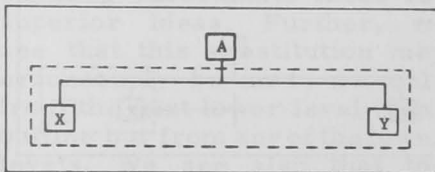

Figure 16.--No special relations possible.

With three or more topics, however, subgroups are easily possible. In fact, they are highly probable. We have great difficulty in finding three or more topics such that the middle topics are equally spaced in thought between the first and last topics. Thus, among three or more topics, two will almost invariably be specially related. So, whenever three or more topics are presented as coordinate, we should suspect that the subordination of ideas is faulty. The greater the number above two, the greater should be our suspicion, for the greater is the possibility of special relations somewhere in the group (fig. 17; compare Panel 2 with the specific example in fig. 11A).

(b) Looking for special relations.--We now see that counting can help us quickly locate potentially erroneous subordination, as when we find, say, six topics presented as coordinate (fig. 18A). Finding

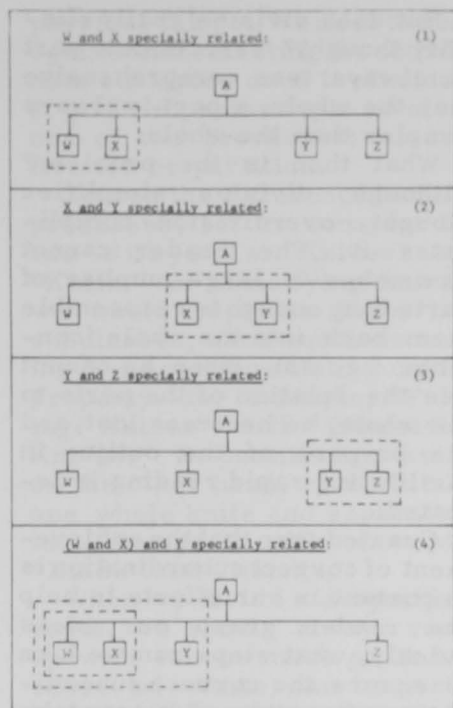

Figure 17.--Some of the special relations possible with four topics.

- I. Oral digestion
- II. Gastric digestion
- III. Intestinal digestion
- IV. Carbohydrate metabolism
- V. Lipid metabolism
- VI. Protein metabolism

Figure 18A.--Six topics presented as coordinate.

six topics or any other number, however, will not prove erroneous subordination. These six topics might, by chance, actually be coordinate. How then do we test for faulty subordination? We look for breaks in thought among the topics (note

the break between Topics III and IV in fig. 18A) as revealed by specially related subgroups. For example, the first three topics are specially related, for they are governed by the idea of digestion; and the last three are specially related, for they are governed by the idea of metabolism.

b. Correcting the error of faulty subordination.--Inserting the missing superior idea governing each specially related subgroup and simultaneously placing the subordinate ideas at the appropriate lower levels in the outline corrects the error (fig. 18B).

When the errors are multiply occurring, as in figure 13, they become hard to correct. Essentially what we have then is a miscellaneous collection of detailed ideas, which, when organized logically, belong at various levels in the outline. To organize these complexly interrelated ideas correctly, we use the same technique as we do when making an outline by induction. This method will be explained later.

- I. Digestion
  - A. Oral digestion
  - B. Gastric digestion
  - C. Intestinal digestion
- II. Metabolism
  - A. Carbohydrate metabolism
  - B. Lipid metabolism
  - C. Protein metabolism

Figure 18B.--Missing governing ideas inserted.

## 2. Helping Ourselves

We now know how to help others correct the error of faulty subordination. We know what to look for. We know that the error consists in the substitution of subordinate ideas for superior ideas. And we know how to look for it. We know that if counting reveals three or more topics presented as coordinate, some of them are probably not truly coordinate. Finally, we know that if any of these topics are specially related, our suspicions concerning the incorrect subordination of ideas are confirmed. We then can correct the error by inserting the missing superior ideas and placing the subordinate ideas at the appropriate lower levels in the outline.

Let us suppose now that instead of correcting the work of others, we ourselves are writing an article. How then do we avoid the commonly occurring error of faulty subordination? Before we consider the answer, we might first ask another question: namely, why is it so important that we avoid this error?

To answer that question, let us go back to fundamentals. Why are we making an outline in the first place? Evidently, to simplify thought--not for ourselves, of course, but for the reader. How then do we simplify thought for him? We do it by division. We take our main idea (say, Topic A) and divide it. Then we take the resulting subdivisions (say, Topics AA and AB) and divide them. We continue in this manner until we arrive at ideas so readily understandable that they need be divided no further.

But does division really simplify thought? Yes. Since a part is always less comprehensive than the whole, a part is always simpler than the whole.

What then is the problem? Although division simplifies thought, overdivision complicates it. The reader cannot remember a large number of parts long enough to reassemble them back into the whole (consider fig. 13). When he cannot see the relation of the parts to the whole, he becomes lost, and the purpose of the outline in facilitating rapid reading is defeated.

Granted then that the achievement of correct subordination is important in our efforts to help the reader grasp our ideas quickly, what steps can we take to ensure the correct subordination of our ideas? We can take two main ones. Taking these steps requires that we give thought both to the correct number of topics to present as coordinate and to the correct relative size of the topics.

a. Choosing the correct number of coordinate topics.-- Under certain unusual circumstances, the correct number of coordinate topics to present is only one. Let us investigate this unusual case for the understanding it will give us and then look into the ordinary case in which more than one topic is the correct number.

(1) When the correct number is only one.-- To handle the problem of the single subtopic, we have to remember that, when we make an outline, we are dealing with ideas and not with

physical things. We need to recognize that selecting the coordinate subtopics used to elucidate a given superior topic involves one of two processes: classification or partition.

To see the difference in these processes, let us consider the two subjects "Knives" and "Knife." In classifying knives, we would separate them into subclasses, each subclass having some common distinguishing property--for example, "Folding Knives" and "Nonfolding Knives." In partitioning knife, on the other hand, we would take one whole knife and separate it into its parts--for example, "Blade" and "Handle."

When we divide a subject into parts, we should always come up with two or more parts because no whole can be partitioned into less than two parts. But does this restriction hold true when we classify? No. When we classify topics into subclasses, we can come up with a single subclass. Suppose, for example, that we want to discuss the subject: "Animals on our Mountain Valley Farm." Suppose also that we want to emphasize the fact that our farm has both domestic and wild animals. Our outline might take the form shown in figure 19A.

Suppose, now, that because of hunting all the bears were killed off. Our outline would take the form shown in figure 19B. At this point, some of us would begin to feel acute discomfort. So, having heard the supposed rule that single subtopics can never logically exist, we would hastily revise our outline as shown in figure 19C. But on looking at this outline, we would see that "Deer" is not

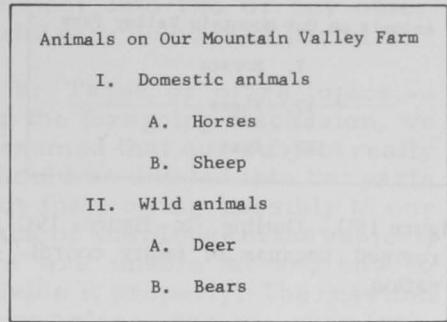

Figure 19A.--Outline showing presence of wild animals on farm.

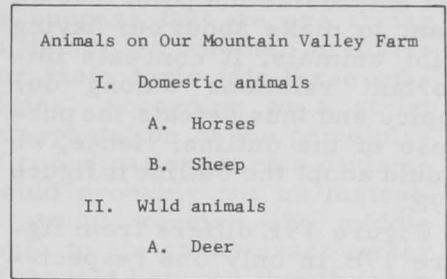

Figure 19B.--Outline in figure 19A corrected following the disappearance of bears.

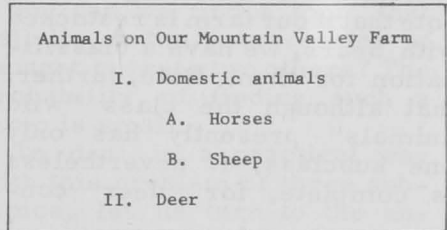

Figure 19C.--Outline in figure 19B revised to eliminate the single subtopic under "Wild animals."

coordinate with "Domestic animals." We therefore would revise the outline, perhaps as shown in figure 19D.

On studying this outline, we would realize that the subject "Deer" is not coordinate with



Animals on Our Mountain Valley Farm

- I. Horses
- II. Sheep
- III. Deer

Figure 19D.--Outline in figure 19C revised because of faulty coordination.

the subjects "Horses" and "Sheep," which form a specially related subgroup. Also, we would see that this outline does not emphasize the point that we want to make about our having wild animals. It conceals important relations among our topics and thus defeats the purpose of the outline. Hence, we would adopt the outline in figure 19E.

Figure 19E differs from figure 19B in only one respect--it shows that the single subclass is deliberate, not the result of thoughtlessness. Otherwise, the two outlines are equivalent.

With the outline in figure 19E, note that if our farm is restocked with bears, we have a classification for them. Note, further, that although the class "wild animals" presently has only one subclass, it nevertheless is complete, for "deer" con-

stitutes the entire class. In contrast, if we were to partition "knife" into "blade," the partitioning would be incomplete. It therefore would be illogical, for, as we saw earlier, one requirement of logical division is that the parts add up to the whole.

But the parts do have to be coordinate whether we are partitioning or classifying. When we classify, unless we are aware of the logical possibility of the single subclass, we may fall into the error of faulty subordination instead of avoiding it.

(2) When the correct number is more than one.--In taking up the presentation of more subtopics than one, let us consider the presentation of two coordinate subtopics before considering the more complex case in which we would present three or more.

(a) Two topics.--Helping us to avoid the substitution of subordinate for superior ideas is the knowledge that coordinate topics usually occur in pairs. When making an outline, we accordingly need not embark on a haphazard search for some indefinite number of coordinate topics. We need to look, at least initially, for only two. We narrow our search by asking ourselves the question: "At this point, what two main subideas, when presented to the reader in proper sequence, will give him complete understanding of the superior idea that we are trying to divide?"

Often we have a subject that, upon first analysis, appears not to yield to two-part division; yet, after we have finished the analysis, we find that it quite naturally falls into two parts.

Animals on Our Mountain Valley Farm

- I. Domestic animals
  - A. Horses
  - B. Sheep
- II. Wild animals: deer

Figure 19E.--Outline in figure 19D corrected because of faulty coordination.

Suppose, for example, our subject is the three-part division of the National Government. Is the Legislative Branch in the exact center of thought between the Executive Branch and the Judicial Branch? Perhaps it is more closely related to the Executive Branch. Despite tradition, could we not think of the Executive and Legislative Branches as the dynamic part of the Government and the Judicial Branch as the restraining part? Answering this question presumes more knowledge of political science than most of us may possess. That the question arises, however, indicates that even our traditional divisions are not necessarily the most logical and that two-part division may be both possible and preferable to division into a larger number.

In trying to divide a given topic into two subtopics, we have to be careful to find the natural dividing point. When we divide naturally, the reader is able to see the logic of our division. The logic then helps him to remember the subdivisions. If on the other hand, we do not find the natural dividing point, the reader will not be able to see the logic and hence will have difficulty in keeping the subdivisions in mind. He will then tend to become lost in our discussion. In that case, the dividing, instead of aiding communication, hinders it.

Accordingly, if we cannot find the one natural point of division, we should divide our subject wherever and however it seems to require rather than at some obviously illogical point. Under no condition should we artificially force the division of our

subject into two or any other arbitrary number of parts.

b. Three or more topics.-- In the foregoing discussion, we assumed that our subject really should be divided into two parts but that, owing possibly to our lack of knowledge of the subject, we are unable to see how to divide it properly. The question now arises, can we ever logically divide a subject into more than two parts?

To answer that question, we have to consider tolerances. For a specific illustration, let us suppose that we are trying to decide on whether to divide our main topic into three subtopics. According to a strict interpretation of the principles of coordination, such a division would probably not be logical. It would require the middle topic to lie at the exact center of thought between the other two topics. Unless it does lie at the exact center, it will form a specially related subgroup with one or the other of the topics, which logic does not permit. But how often can we find a topic that will lie at the exact center of thought between two others? The probability of finding such a topic is small.

To deal in a practical way with this problem of three subtopics, let us turn to the engineer for help. An engineer never sets his tolerances higher than need be. He adjusts them to meet the requirements of each particular case. In the same way, we can adjust our coordination tolerances (fig. 20) to meet the requirements of the particular outline that we are constructing and of the particular part of the outline that we are constructing.

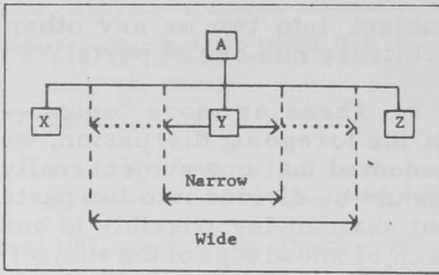

Figure 20.--Tolerances in range of thought.

Whether or not we can present three or more topics as coordinate now depends on our tolerances. As we narrow them, our chances for finding three or more coordinate topics reduces; as we widen them, our chances increases.

The crucial question now is: What determines our tolerances? The answer is: The complexity of our subject matter. The more complex our subject--that is, the more difficult it is for the reader to understand--the closer we should make our tolerances and therefore the more rigorously logical we should be.

When our topics are simple, the reader may not need the aid that organizing them into logical subgroups would give him. But even when our topics are inherently easy to understand, the reader may not be able to commit them to memory

as fast as we present them to him. So a large number of topics may be difficult for him to assimilate, even though each topic, by itself, may be simple. To aid the reader's memory (fig. 21), we should show him how the topics in our larger groups are interrelated. Because of this problem of memory, we seldom should present more than four or five topics as coordinate in any one group.

b. Choosing the correct size of coordinate topics.--In helping ourselves to achieve the correct subordination of our ideas, we have found how to choose the correct number of subtopics to present as coordinate. We have found that, depending upon the circumstances, we may present one (with the possibility of later adding other subtopics) and we may present three or more but that usually we will present two and that seldom will we present more than four or five. We still have one further problem that may give us trouble--namely, that of the relative size, or scope, of our coordinate topics.

Returning to the equation we used earlier ( $AA + AB = A$ ) gives us a quick grasp of the principle underlying the relative size of coordinate topics: within the governing limits of A, either

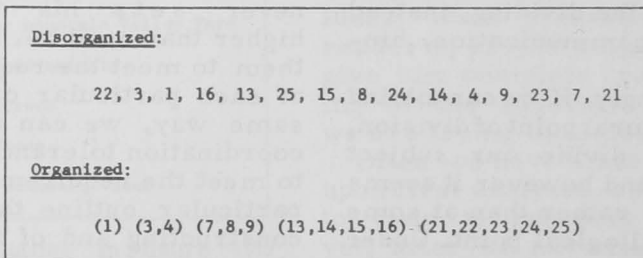

Figure 21.--Example of organization as an aid to memory.

AA or AB can be of any size allowed by the natural division of A.

It is sometimes thought that coordinate topics must be of the same size--that, for example, if A is 4, then AA must be 2 and AB must be 2. Adhering to such a restriction would very often force us into faulty subordination. We often have, for example, a topic (such as Topic AA, fig. 22) that we want to include but that does not require much discussion. Because it is simple, we may conclude that it is subordinate. Yet, try as we will, we cannot fit it under any one of our major ideas, though it clearly belongs

in our subject area. Such topics usually are major topics themselves and fit into our outline logically when we recognize their true status--namely, that they are coordinate and not subordinate.

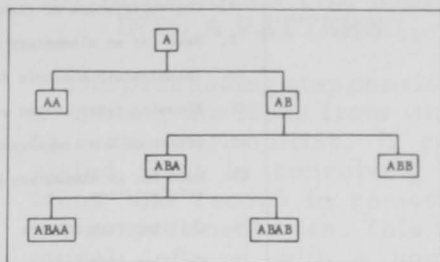

Figure 22.--Differing complexities among coordinate topics.

## II. INDUCTIVE METHOD OF OUTLINE FORMATION

We have now seen that making an outline by the deductive method consists essentially of achieving correct coordination and correct subordination.

The method works well when we have our main idea, Topic A, at the start. But what if we do not have our main idea clearly in mind? Often, at the beginning, we have only a number of miscellaneous detailed ideas that we want to weave into an article. What then?

As Chapman<sup>1</sup> has suggested, we can use the inductive method. This method involves two main steps: getting the ideas and arranging them into a pattern.

<sup>1</sup>Stuart W. Chapman, "Organization; First Steps," a lecture given in A Short Course in Technical Writing, University of Washington, Seattle, Washington, 1964.

### A. GETTING THE IDEAS

Getting the ideas needed to make our outline involves listing our ideas as they occur to us and then selecting from among them to pick the ones that can be formed into the pattern that we ultimately want.

#### 1. Listing

Our first step is creative. As such, we temporarily suspend judgment and concern ourselves only with conceiving the ideas. To do that, we list them on a sheet of paper or on 3- by 5-inch cards as fast as they haphazardly come to mind. Figure 23 shows a typical list of topics that might result.

#### 2. Selecting

When we have exhausted our store of ideas and can think of

1. Storing frozen fish
2. Characteristics of refrigerating media and processes
3. Potential impact of refrigeration on the Asiatic fisheries
4. Importance of refrigeration
5. Freezing fish fillets
6. Quality control
7. Need for an elementary knowledge of fish microbiology
8. Characteristics of fish
9. Need for an elementary knowledge of fish chemistry
10. Techno-socio-economic implications of refrigeration
11. Planning refrigerated vessels and plants
12. Effect of low temperature on microorganisms
13. Need for an elementary knowledge of the principles of refrigeration
14. Chilling fish fillets
15. Chilling fish
16. Thawing frozen fish
17. Storing chilled fish
18. Freezing fish

Figure 23.--Typical list.

no additional ones, we bring our judgment back into operation, and from the list of topics we have made, select the pertinent ones. Then, after we have selected the pertinent ideas, we next select from them our so-called "what" ideas.

a. The pertinent ideas.--Listing our haphazardly generated ideas gives us a fairly good concept of what our subject area should be. Hence, after creating the list, we review our ideas, one by one, and eliminate any that we decide should not be included in our article (fig. 24).

Setting aside any topics that we do not wish to discuss in the article enables us to form a homogeneous set. This homogeneity tells us that we have an overall "A" idea, even though, at the moment, we do not yet

- |   |
|---|
| 1. Storing frozen fish  |
| 2. Characteristics of refrigerating media and processes                 |
| Omit - 3. Potential impact of refrigeration on the Asiatic fisheries    |
| 4. Importance of refrigeration  |
| 5. Freezing fish fillets  |
| 6. Quality control  |
| 7. Need for an elementary knowledge of fish microbiology                |
| 8. Characteristics of fish  |
| 9. Need for an elementary knowledge of fish chemistry                   |
| Omit - 10. Techno-socio-economic implications of refrigeration          |
| 11. Planning refrigerated vessels and plants                            |
| 12. Effect of low temperature on microorganisms                         |
| 13. Need for an elementary knowledge of the principles of refrigeration |
| 14. Chilling fish fillets   |
| 15. Chilling fish   |
| 16. Thawing frozen fish   |
| 17. Storing chilled fish  |
| 18. Freezing fish   |

Figure 24.--Eliminating nonpertinent ideas.

know exactly what it is. (In the outline that we shall develop later, we shall indicate this missing unidentified idea by a boxed asterisk [\*] in the manner indicated in figure 25).

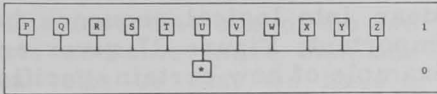

Figure 25.--Representation of unknown A idea by a boxed asterisk.

b. The what ideas.--From the preceding step, we have obtained a homogeneous set of ideas from which to construct our outline. Nevertheless, if we were to try to form one from this set, we would probably have difficulty. Some of the ideas might not be suitable--that is, they might not be of the kind from which a topic outline can be made.

Ideas fall into two classes: "what" ideas and "why" ideas. The "why" ideas explain why the "what" ideas are significant. They thereby help give the reader an understanding of them. However, only the what ideas appear in our outline. The why ideas are inserted later when we write the intro-

ductions to our article. Hence, our next step is to select our what ideas. We make this selection by setting aside our why ideas (fig. 26). They are usually relatively few.

## B. ARRANGING THE IDEAS INTO A PATTERN

The preceding step consisted in getting the ideas from which to make our outline. It consisted first in conceiving the ideas and second in removing the nonpertinent ones. This removal left us with a homogeneous set. From this set, any why ideas could be taken out to leave us a subset of detailed what ideas. These what ideas constitute the goal we have been aiming at. They are the material from which we construct our topic outline.

Arranging our detailed what ideas into a logical pattern involves (1) separating them into

- |       |   |
|-------|---|
|       | 1. Storing frozen fish  |
|       | 2. Characteristics of refrigerating media and processes                 |
| Why - | 4. Importance of refrigeration  |
|       | 5. Freezing fish fillets  |
|       | 6. Quality control  |
| Why - | 7. Need for an elementary knowledge of fish microbiology                |
|       | 8. Characteristics of fish  |
| Why - | 9. Need for an elementary knowledge of fish chemistry                   |
|       | 11. Planning refrigerated vessels and plants                            |
|       | 12. Effect of low temperature on microorganisms                         |
| Why - | 13. Need for an elementary knowledge of the principles of refrigeration |
|       | 14. Chilling fish fillets   |
|       | 15. Chilling fish   |
|       | 16. Thawing frozen fish   |
|       | 17. Storing chilled fish  |
|       | 18. Freezing fish   |

Figure 26.--Setting aside why ideas.

the appropriate levels of division in our outline and then (2) synthesizing any missing ideas at the higher levels.

### 1. Separating the Ideas According to Levels of Thought

All our detailed ideas do not necessarily occur at the same level. Some are more general (or, alternatively, are more specific) than others are. Hence, we must determine the relative generality or specificity of each idea in our set.

Arranging the ideas according to their level requires that we (a) arrange them into logical sequence and then (b) find the major dividing point among them.

a. Placing the ideas in logical sequence.--As we saw earlier, ideas that are suitable for presentation in the kind of articles of major concern here usually fall into a sequential pattern. Hence, arranging our detailed

ideas into logical sequence is important. Figure 27 gives an example of how certain specific haphazardly arranged ideas can be rearranged logically.

b. Dividing the ideas into subgroups.--Dividing our logically arranged ideas into major subgroups can be facilitated by our knowledge of two facts: (1) Most ideas logically subdivide into two parts and (2) any one of these parts need not contain more than one idea. The technique can best be followed by the use of symbols. (A longer example, however, is given in the appendix to show how this technique works in practice.)

Suppose that after we arrange our ideas into logical order, they fall into the following sequence: AA, ABAAA, ABAAB, ABABA, ABABB, and ABB. On searching for common ideas among these topics, we would find that the major break in thought occurs as indicated in figure 28.

<u>Original sequential number</u>		<u>Logical sequential number</u>	
12	-	1.	Effect of low temperature on microorganisms
8	-	2.	Characteristics of fish
2	-	3.	Characteristics of refrigerating media and processes
15	-	4.	Chilling fish
17	-	5.	Storing chilled fish
18	-	6.	Freezing fish
1	-	7.	Storing frozen fish
16	-	8.	Thawing frozen fish
14	-	9.	Chilling fish fillets
5	-	10.	Freezing fish fillets
11	-	11.	Planning refrigerated vessels and plants
6	-	12.	Quality control

Figure 27.--Reordering topics into logical sequence.

The fact that one of the two parts contains more than one idea tells us that we have a missing unifying superior idea--in this case, an idea missing at Level 1 (fig. 29).

Since the group at Level 2 contains more than two topics, we again look for a major break in thought (fig. 30). Repeating the reasoning in the preceding step, we infer the existence of a missing unifying

superior idea at Level 2 (fig. 31).

Continuing with the technique used earlier, we again look for a major break in thought (fig. 32). Since each of the resulting two groups contains two ideas, we infer the existence of two missing unifying superior ideas at Level 3 (fig. 33). The separation of our ideas into levels of outline division is now complete.

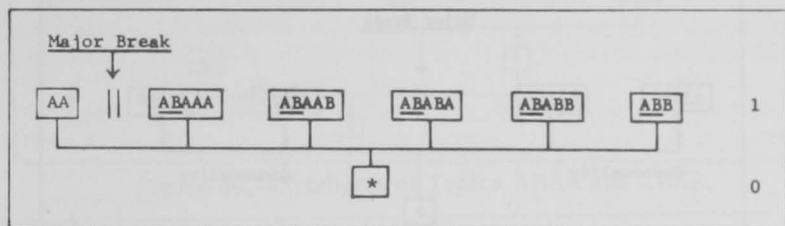

Figure 28.--Major break in thought.

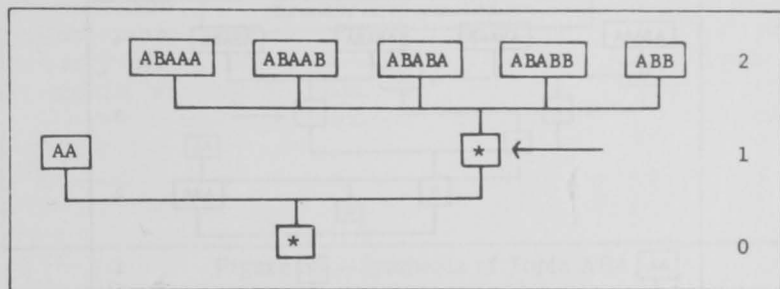

Figure 29.--Missing idea inferred to exist at Level 1.

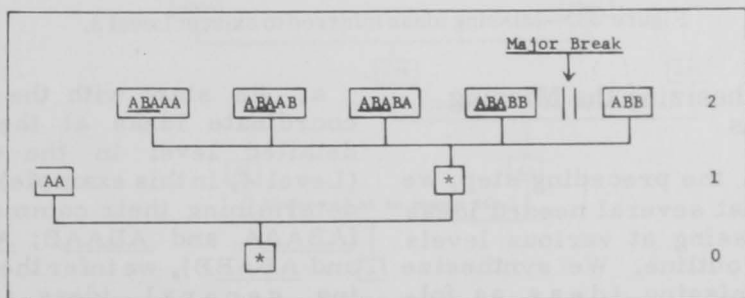

Figure 30.--Second major break in thought.



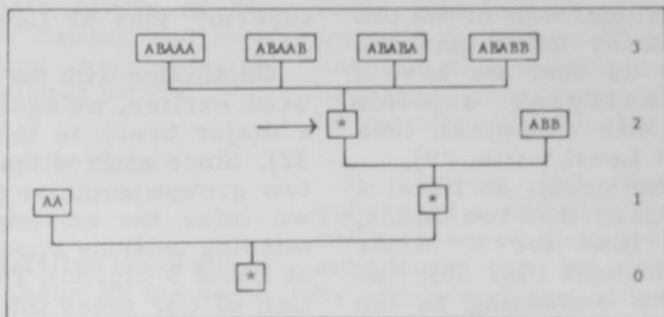

Figure 31.--Missing idea inferred to exist at Level 2.

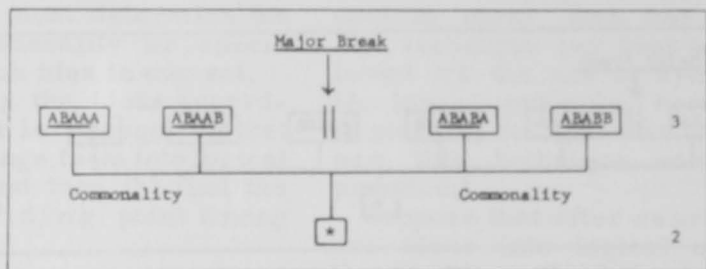

Figure 32.--Third major break in thought,

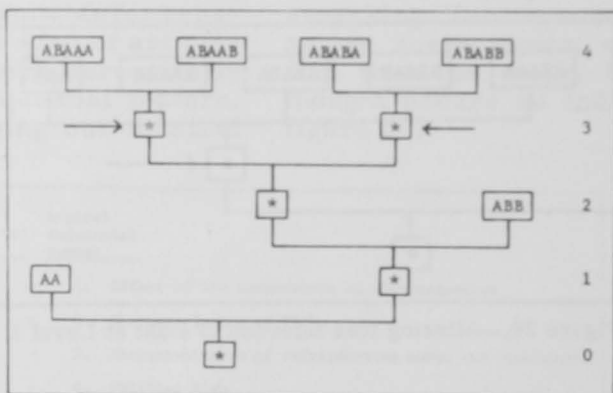

Figure 33.--Missing ideas inferred to exist at Level 3.

## 2. Synthesizing the Missing Ideas

From the preceding step, we know that several needed ideas are missing at various levels in the outline. We synthesize these missing ideas as follows:

a. We start with the known coordinate ideas at the most detailed level in the outline (Level 4, in this example). After determining their commonality (ABAAA and ABAAB; ABABA and ABABB), we infer the unifying general ideas (ABAA: ABAB, at Level 3; fig. 34).

b. We take these newly discovered coordinate unifying ideas and again infer the unifying general ideas (ABA at Level 2; fig. 35).

c. We continue until we have all our unknown superior unifying ideas synthesized, including

Topic A (fig. 36). Thus, by the inductive method, we have now synthesized the same outline that we would have made had we known the overall idea, Topic A, at the start.

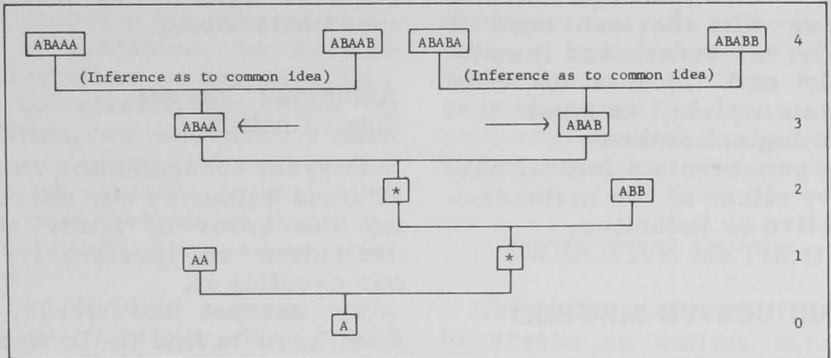

Figure 34.--Synthesis of Topics ABAA and ABAB.

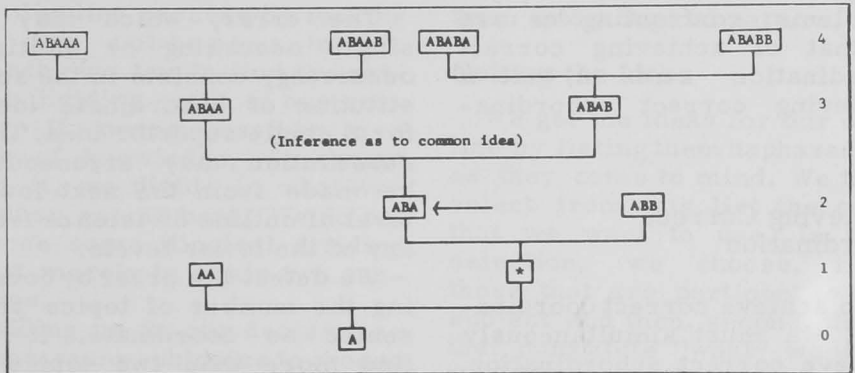

Figure 35.--Synthesis of Topic ABA.

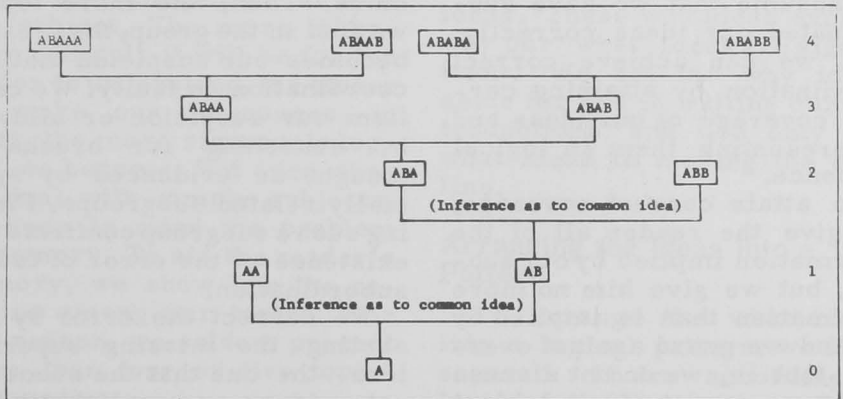

Figure 36.--Synthesis of Topic A.

## SUMMARY

This manual is based on two premises--namely, (1) that to ensure the effective communication of ideas from our minds to the reader's mind, we must write our article in such a manner that he can read it rapidly yet understand it completely and (2) that to write such an article, we must start with a logical outline.

We can create a logical outline by either of two methods--deductive or inductive.

### DEDUCTIVE METHOD

When we make an outline by the deductive method, the major problems confronting us are (1) that of achieving correct coordination and (2) that of achieving correct subordination.

#### Achieving Correct Coordination

To achieve correct coordination, we must simultaneously achieve correct subordination. If, for the moment, however, we assume that we have subordinated our ideas correctly, then we can achieve correct coordination by attaining correct coverage of our ideas and by presenting them in logical sequence.

To attain correct coverage, we give the reader all of the information implied by our subject, but we give him no more information than is implied by it. And we guard against overlap--that is, we do not discuss the same aspect of our subject in two or more different places.

To achieve correct sequence, we present our information to the reader in such a manner that he always has enough background knowledge to understand the next topic in our series of coordinate topics.

#### Achieving Correct Subordination

Correct subordination can be attained either by our correcting the error of faulty subordination or, preferably, by our avoiding it.

To correct the error, we first have to find it. To find it, we have to know its nature and how to detect it.

The error, which may be singly occurring or multiply occurring, consists in the substitution of subordinate ideas for a single superior idea. This substitution may erroneously be made from the next lower level of outline division or from any of the lower levels.

We detect the error by counting the number of topics presented as coordinate. If we find more than two topics in any group, we become suspicious. Then, the more topics we find in the group, the greater becomes our suspicion that the coordination is faulty. We confirm our suspicion or allay it by searching for breaks in thought as evidenced by specially related subgroups. Finding such a subgroup confirms the existence of the error of faulty subordination.

We correct the error by inserting the missing superior idea--the one that the subordinate ideas were substituted for--into our outline and then

placing the subordinate ideas at the appropriate lower levels.

We avoid the error of faulty subordination by choosing the correct number of subtopics to present as coordinate and the correct relative size of subtopics.

In choosing the correct number of subtopics, we keep in mind whether we are partitioning or classifying. When we partition, we must always have two or more subtopics, but when we classify, we may have only one subtopic if that subtopic is the only member in its class.

When dividing a given topic, we know, however, that it will usually divide into two subtopics. Accordingly, we start the dividing process by looking for two subtopics. In this search, we try to find the natural dividing point of our subject. If, owing possibly to a lack of knowledge, we cannot find it, we divide in whatever manner seems best. We do not choose some illogical dividing point merely to attain two subtopics.

Aiding us in our decision as to how many subtopics to choose is the concept of tolerances. We adjust our tolerances to suit our subject. The more inherently difficult it will be for the reader to understand, the closer we make our tolerances--in short, the more rigorously logical we become. But even when we deal with simple subjects, we keep in mind the problem of memory. To aid the reader's memory, we show him the relations among our topics. For that reason, we seldom present more than four or five topics as coordinate.

In searching for coordinate subtopics, we are aided by the knowledge that they are not necessarily of the same complexity. We know that one subtopic may require much discussion in order to elucidate it and that the other subtopic or subtopics may be almost self-evident and therefore require little discussion. This knowledge keeps us from placing coordinate ideas that are simple under those that are complex.

## INDUCTIVE METHOD

Using the inductive method to create an outline consists essentially in getting our detailed ideas and then arranging them into a logical pattern.

### Getting the Ideas

We get the ideas for our outline by listing them haphazardly as they come to mind. We then select from this list the ones that we want to use. In this selection, we choose, first those that are pertinent to our subject and then, second, those that constitute "what" we want to talk about. That is, some of our pertinent ideas will be "why" ideas. These why ideas explain why our "what" ideas are significant. We set the why ideas aside for use in writing our introductions and use only the what ideas in making the outline.

### Arranging the Ideas Into a Pattern

To arrange the what ideas into a logical pattern, we first separate them according to level of division in our outline.

We start by arranging the what ideas into logical sequence. Then, knowing that most sets of ideas usually divide into two major groups, we search for the largest single break in thought among the ideas by noting commonalities. We next take each resulting subgroup and repeat the process of looking for the largest break in thought. We continue this process until we have our ideas separated as to level. Starting with our most detailed coordinate ideas, we then note their commonality and next decide what superior topic will express the common idea. We continue in this manner until we have

all the missing superior ideas synthesized.

### CONCLUDING REMARKS

By the techniques presented here, we are able to construct a strictly logical outline whether we start without our overall idea firmly in mind or whether we start with only a miscellaneous collection of detailed ideas that we wish to weave into a coherent whole. The use of these techniques thus helps us in our efforts to write an article that can be read rapidly yet understood completely.

### ACKNOWLEDGMENT

When this paper was being planned and written, constructive criticism was received from Lena Baldwin, Scientific Editor, and Mary-Frances Tripple, Abstracter, both of the

Bureau of Commercial Fisheries Branch of Reports, Seattle, and from Myron L. White, Associate Professor, College of Engineering, University of Washington, Seattle.

## APPENDIX

### MAKING AN OUTLINE BY THE INVERSE CLASSICAL METHOD

1. We separate our ideas according to outline level.

a. Assuming that we have a homogeneous set of "what" ideas (which tells us that we have the subject matter for which we can eventually frame a title) arranged in logical sequence (see fig. 27), we separate the ideas at the point where the greatest break in thought occurs:

Title: \_\_\_\_\_

1. Effect of low temperature on microorganisms

Break - - - - -

2. Characteristics of fish
3. Characteristics of refrigerating media and processes
4. Chilling fish
5. Storing chilled fish
6. Freezing fish
7. Storing frozen fish
8. Thawing frozen fish
9. Chilling fish fillets
10. Freezing fish fillets
11. Planning refrigerated vessels and plants
12. Quality control

b. On the basis of the break in thought, we group our ideas according to their apparent level of thought, filling in the general ideas where we can and leaving blank spaces in our outline for missing general ideas that are needed to unify a set of subideas:

Title: \_\_\_\_\_

I. Effect of low temperature on microorganisms



II. \_\_\_\_\_

2. Characteristics of fish
3. Characteristics of refrigerating media and processes
4. Chilling fish
5. Storing chilled fish
6. Freezing fish
7. Storing frozen fish
8. Thawing frozen fish
9. Chilling fish fillets
10. Freezing fish fillets
11. Planning refrigerated vessels and plants
12. Quality control

c. We repeat the above-mentioned Steps a and b as often as is required to get all our ideas into place at their appropriate level:

Repetition 1

Search for break in thought:

Title: \_\_\_\_\_

I. Effect of low temperature on microorganisms

II. \_\_\_\_\_

2. Characteristics of fish
3. Characteristics of refrigerating media and processes
4. Chilling fish
5. Storing chilled fish
6. Freezing fish
7. Storing frozen fish
8. Thawing frozen fish
9. Chilling fish fillets
10. Freezing fish fillets
11. Planning refrigerated vessels and plants

Break - - - - -

12. Quality control

Provision for missing general ideas implied by the break:

Title: \_\_\_\_\_

I. Effect of low temperature on microorganisms

II. \_\_\_\_\_

A. \_\_\_\_\_ ←

2. Characteristics of fish
3. Characteristics of refrigerating media and processes
4. Chilling fish
5. Storing chilled fish
6. Freezing fish
7. Storing frozen fish
8. Thawing frozen fish
9. Chilling fish fillets
10. Freezing fish fillets
11. Planning refrigerated vessels and plants

B. Quality control ←

Repetition 2

Search for the break in thought:

Title: \_\_\_\_\_

I. Effect of low temperature on microorganisms

II. \_\_\_\_\_

A. \_\_\_\_\_

- 2. Characteristics of fish
- 3. Characteristics of refrigerating media and processes

Break - - - - -

- 4. Chilling fish
- 5. Storing chilled fish
- 6. Freezing fish
- 7. Storing frozen fish
- 8. Thawing frozen fish
- 9. Chilling fish fillets
- 10. Freezing fish fillets
- 11. Planning refrigerated vessels and plants

B. Quality control

Provision for missing general ideas implied by the break:

Title: \_\_\_\_\_

I. Effect of low temperature on microorganisms

II. \_\_\_\_\_

A. \_\_\_\_\_

- 1. \_\_\_\_\_ 
  - a. Characteristics of fish
  - b. Characteristics of refrigerating media and processes

- 2. \_\_\_\_\_ 
  - 4. Chilling fish
  - 5. Storing chilled fish
  - 6. Freezing fish
  - 7. Storing frozen fish
  - 8. Thawing frozen fish
  - 9. Chilling fish fillets
  - 10. Freezing fish fillets
  - 11. Planning refrigerated vessels and plants

B. Quality control



Repetition 3

Search for the break in thought:

Title: \_\_\_\_\_

I. Effect of low temperature on microorganisms

II. \_\_\_\_\_

A. \_\_\_\_\_

1. \_\_\_\_\_

- a. Characteristics of fish
- b. Characteristics of refrigerating media and processes

2. \_\_\_\_\_

- 4. Chilling fish
- 5. Storing chilled fish
- 6. Freezing fish
- 7. Storing frozen fish
- 8. Thawing frozen fish
- 9. Chilling fish fillets
- 10. Freezing fish fillets

Break - - - - -

11. Planning refrigerated vessels and plants

B. Quality control

Provision for missing general ideas implied by the break:

I. Effect of low temperature on microorganisms

II. \_\_\_\_\_

A. \_\_\_\_\_

1. \_\_\_\_\_

- a. Characteristics of fish
- b. Characteristics of refrigerating media and processes

2. \_\_\_\_\_

a. \_\_\_\_\_

- 4. Chilling fish
- 5. Storing chilled fish
- 6. Freezing fish
- 7. Storing frozen fish
- 8. Thawing frozen fish
- 9. Chilling fish fillets
- 10. Freezing fish fillets

b. Planning refrigerated vessels and plants

B. Quality control



Repetition 4

Search for the break in thought:

Title: \_\_\_\_\_

I. Effect of low temperature on microorganisms

II. \_\_\_\_\_

A. \_\_\_\_\_

1. \_\_\_\_\_

- a. Characteristics of fish
- b. Characteristics of refrigerating media and processes

2. \_\_\_\_\_

a. \_\_\_\_\_

- 4. Chilling fish
- 5. Storing chilled fish
- 6. Freezing fish
- 7. Storing frozen fish
- 8. Thawing frozen fish

Break

-----

9. Chilling fish fillets

10. Freezing fish fillets

b. Planning refrigerated vessels and plants

B. Quality control

Provision for missing general ideas implied by the break:

A. \_\_\_\_\_

1. \_\_\_\_\_

- a. Characteristics of fish
- b. Characteristics of refrigerating media and processes

2. \_\_\_\_\_

a. \_\_\_\_\_

(1) \_\_\_\_\_

- 4. Chilling fish
- 5. Storing chilled fish
- 6. Freezing fish
- 7. Storing frozen fish
- 8. Thawing frozen fish



(2) \_\_\_\_\_

- (a) Chilling fish fillets
- (b) Freezing fish fillets



b. Planning refrigerated vessels and plants

B. Quality control

Repetition 5

Search for the break in thought:

Title: \_\_\_\_\_

I. Effect of low temperature on microorganisms

II. \_\_\_\_\_

A. \_\_\_\_\_

1. \_\_\_\_\_

- a. Characteristics of fish
- b. Characteristics of refrigerating media and processes

2. \_\_\_\_\_

a. \_\_\_\_\_

(1) \_\_\_\_\_

- 4. Chilling fish
- 5. Storing chilled fish

Break

- 
- 6. Freezing fish
  - 7. Storing frozen fish
  - 8. Thawing frozen fish

(2) \_\_\_\_\_

- (a) Chilling fish fillets
- (b) Freezing fish fillets
- b. Planning refrigerated vessels and plants

B. Quality control

Provision for missing general ideas implied by the break:

a. \_\_\_\_\_

(1) \_\_\_\_\_

- (a) \_\_\_\_\_ ←
- (a.1) Chilling fish
- (a.2) Storing chilled fish

- (b) \_\_\_\_\_ ←
- 6. Freezing fish
- 7. Storing frozen fish
- 8. Thawing frozen fish

(2) \_\_\_\_\_

- (a) Chilling fish fillets
- (b) Freezing fish fillets
- b. Planning refrigerated vessels and plants

Repetition 6

Search for the break in thought:

Title: \_\_\_\_\_

I. Effect of low temperature on microorganisms

II. \_\_\_\_\_

A. \_\_\_\_\_

1. \_\_\_\_\_

a. Characteristics of fish

b. Characteristics of refrigerating media and processes

2. \_\_\_\_\_

a. \_\_\_\_\_

(1) \_\_\_\_\_

(a) \_\_\_\_\_

(a.1) Chilling fish

(a.2) Storing chilled fish

(b) \_\_\_\_\_

6. Freezing fish

7. Storing frozen fish

Break

8. Thawing frozen fish

(2) \_\_\_\_\_

(a) Chilling fish fillets

(b) Freezing fish fillets

b. Planning refrigerated vessels and plants

B. Quality control

Provision for missing general ideas implied by the break:

(1) \_\_\_\_\_

(a) \_\_\_\_\_

(a.1) Chilling fish

(a.2) Storing chilled fish

(b) \_\_\_\_\_

(b.1) \_\_\_\_\_

(b.1.1) Freezing fish

(b.1.2) Storing frozen fish

(b.2) Thawing frozen fish



(2) \_\_\_\_\_

(a) Chilling fish fillets

(b) Freezing fish fillets

2. We synthesize our missing superior ideas.

a. To synthesize our unknown superior ideas, we start with our known coordinate ideas at our most detailed level of thought and, after determining their commonality, infer their unifying generalizing idea. We make the title of coordinate topics parallel in form.

Title: \_\_\_\_\_

I. Effect of low temperature on microorganisms

II. \_\_\_\_\_

A. \_\_\_\_\_

1. \_\_\_\_\_

- a. Characteristics of fish
- b. Characteristics of refrigerating media and processes

2. \_\_\_\_\_

a. \_\_\_\_\_

(1) \_\_\_\_\_

(a) \_\_\_\_\_

- (a.1) Chilling fish
- (a.2) Storing chilled fish

(b) \_\_\_\_\_

- (b.1) Freezing and storing fish ←
- (b.1.1) Freezing fish
- (b.1.2) Storing frozen fish

- (b.2) Thawing frozen fish ←

(2) \_\_\_\_\_

- (a) Chilling fish fillets
- (b) Freezing fish fillets

b. Planning refrigerated vessels and plants

B. Quality control

b. We repeat Step a, until we have all the missing superior ideas synthesized.

Repetition 1

Title: \_\_\_\_\_

I. Effect of low temperature on microorganisms

II. \_\_\_\_\_

A. \_\_\_\_\_

1. \_\_\_\_\_

a. Characteristics of fish

b. Characteristics of refrigerating media and processes

2. \_\_\_\_\_

a. \_\_\_\_\_

(1) \_\_\_\_\_

(a) Chilled fish

(a.1) Chilling fish

(a.2) Storing chilled fish



(b) Frozen fish

(b.1) Freezing and storing fish

(b.1.1) Freezing fish

(b.1.2) Storing fish

(b.2) Thawing frozen fish



(2) \_\_\_\_\_

(a) Chilling fish fillets

(b) Freezing fish fillets

b. Planning refrigerated vessels and plants

B. Quality control

Repetition 2

Title: \_\_\_\_\_

I. Effect of low temperature on microorganisms

II. \_\_\_\_\_

A. \_\_\_\_\_

1. \_\_\_\_\_

- a. Characteristics of fish
- b. Characteristics of refrigerating media and processes

2. \_\_\_\_\_

a. \_\_\_\_\_

(1) Chilled and frozen fish

(a) Chilled fish

(a.1) Chilling fish

(a.2) Storing chilled fish

(b) Frozen fish

(b.1) Freezing and storing fish

(b.1.1) Freezing fish

(b.1.2) Storing fish

(b.2) Thawing frozen fish

(2) Chilled and frozen fish fillets

(a) Chilling fish fillets

(b) Freezing fish fillets

b. Planning refrigerated vessels and plants

B. Quality control

Title: \_\_\_\_\_

I. Effect of low temperature on microorganisms

II. \_\_\_\_\_

A. \_\_\_\_\_

1. \_\_\_\_\_

- a. Characteristics of fish
- b. Characteristics of refrigerating media and processes

2. \_\_\_\_\_

a. Handling chilled and frozen fish and fillets 

- (1) Chilled and frozen fish
  - (a) Chilled fish
    - (a.1) Chilling fish
    - (a.2) Storing chilled fish
  - (b) Frozen fish
    - (b.1) Freezing and storing fish
      - (b.1.1) Freezing fish
      - (b.1.2) Storing fish
    - (b.2) Thawing frozen fish

- (2) Chilled and frozen fish fillets
  - (a) Chilling fish fillets
  - (b) Freezing fish fillets

b. Planning refrigerated vessels and plants 

B. Quality control



Repetition 4

Title: \_\_\_\_\_

I. Effect of low temperature on microorganisms

II. \_\_\_\_\_

A. \_\_\_\_\_

1. Fundamentals 

- a. Characteristics of fish
- b. Characteristics of refrigerating media and processes

2. Application of fundamentals 

a. Handling chilled and frozen fish and fillets

(1) Chilled and frozen fish

(a) Chilled fish

(a.1) Chilling fish

(a.2) Storing chilled fish

(b) Frozen fish

(b.1) Freezing and storing fish

(b.1.1) Freezing fish

(b.1.2) Storing fish

(b.2) Thawing frozen fish

(2) Chilled and frozen fish fillets

(a) Chilling fish fillets

(b) Freezing fish fillets

b. Planning refrigerated vessels and plants

B. Quality control

Repetition 5

Title: \_\_\_\_\_

I. Effect of low temperature on microorganisms

II. \_\_\_\_\_

A. Processing 

1. Fundamentals

- a. Characteristics of fish
- b. Characteristics of refrigerating media and processes

2. Application of fundamentals

a. Handling chilled and frozen fish and fillets

(1) Chilled and frozen fish

(a) Chilled fish

(a.1) Chilling fish

(a.2) Storing chilled fish

(b) Frozen fish

(b.1) Freezing and storing fish

(b.1.1) Freezing fish

(b.1.2) Storing fish

(b.2) Thawing frozen fish

(2) Chilled and frozen fish fillets

(a) Chilling fish fillets

(b) Freezing fish fillets

b. Planning refrigerated vessels and plants

B. Quality control 

## Repetition 6

Title: \_\_\_\_\_

I. Effect of refrigeration on microorganisms ←

II. Techniques of refrigeration ←

### A. Processing

#### 1. Fundamentals

- a. Characteristics of fish
- b. Characteristics of refrigerating media and processes

#### 2. Application of fundamentals

##### a. Handling chilled and frozen fish and fillets

###### (1) Chilled and frozen fish

###### (a) Chilled fish

- (a.1) Chilling fish
- (a.2) Storing chilled fish

###### (b) Frozen fish

- (b.1) Freezing and storing fish
  - (b.1.1) Freezing fish
  - (b.1.2) Storing fish
- (b.2) Thawing frozen fish

###### (2) Chilled and frozen fish fillets

- (a) Chilling fish fillets
- (b) Freezing fish fillets

##### b. Planning refrigerated vessels and plants

### B. Quality control

REFRIGERATION OF FISH PRODUCTS ←

- I. Effect of refrigeration on microorganisms
- II. Techniques of refrigeration
  - A. Processing
    - 1. Fundamentals
      - a. Characteristics of fish
      - b. Characteristics of refrigerating media and processes
    - 2. Application of fundamentals
      - a. Handling chilled and frozen fish and fillets
        - (1) Chilled and frozen fish
          - (a) Chilled fish
            - (a.1) Chilling fish
            - (a.2) Storing chilled fish
          - (b) Frozen fish
            - (b.1) Freezing and storing
              - (b.1.1) Freezing fish
              - (b.1.2) Storing frozen fish
            - (b.2) Thawing frozen fish
        - (2) Chilled and frozen fish fillets
          - (a) Chilling fish fillets
          - (b) Freezing fish fillets
      - b. Planning refrigerated vessels and plants
    - B. Quality control

\* \* \*

Now we have a working outline. Evidently the titles are rough and will have to be refined, but the scope and interrelation of our topics are established and the sequence of our discussion is laid out, ready to be followed.