

# Aquaculture and Stock Enhancement of Finfish Proceedings of the Thirty-fourth U.S.-Japan Aquaculture Panel Symposium

San Diego, California  
November 7–9, 2005

Robert Stickney, Robert Iwamoto, and Michael Rust, editors



© 2002 Natalie Fobes, all rights reserved



**U.S. DEPARTMENT OF COMMERCE**  
**National Oceanic and Atmospheric Administration**  
National Marine Fisheries Service

**NOAA Technical Memorandum NMFS-F/SPO-85**



**Aquaculture and Stock Enhancement  
of Finfish**  
**Proceedings of the Thirty-fourth  
U.S.-Japan Aquaculture Panel  
Symposium**

**San Diego, California  
November 7–9, 2005**

Robert Stickney, Robert Iwamoto, and Michael Rust, editors

NOAA Technical Memorandum NMFS-F/SPO-85  
October 2007



**U.S. Department of Commerce**

Carlos M. Gutierrez, Secretary

**National Oceanic and Atmospheric Administration**

Vice Admiral Conrad C. Lautenbacher, Jr., USN (Ret.)  
Under Secretary for Oceans and Atmosphere

**National Marine Fisheries Service**

William T. Hogarth, Assistant Administrator for Fisheries

**Suggested citation:**

Stickney, R., R. Iwamoto, and M. Rust (editors). 2007. Aquaculture and Stock Enhancement of Finfish: Proceedings of the Thirty-fourth U.S.-Japan Aquaculture Panel Symposium, San Diego, California, November 7–9, 2005. U.S. Dept. Commerce, NOAA Tech. Memo. NMFS-F/SPO-85, 76 p.

**A copy of this report may be obtained from:**

Northwest Fisheries Science Center  
2725 Montlake Boulevard East  
Seattle, Washington 98112

**Or online at:**

<http://spo.nmfs.noaa.gov/tm/>

Reference throughout this document to trade names does not imply endorsement by the National Marine Fisheries Service, NOAA.



# Table of Contents

<b>Introduction</b>	
<b>Species Reports</b>	
Seriola	
<b>Current Situation of Technical Developments in Seed Production of Yellowtail (<i>Seriola quinqueradiata</i>) in Japan</b>	<b>1</b>
Keiichi Mushiake, Hideki Yamazaki, and Hiroshi Fujimoto	
Sciaenids	
<b>Culture of Spotted Seatrout (<i>Cynoscion nebulosus</i>) in a Closed, Recirculating System</b>	<b>5</b>
Reginald B. Blaylock, Angelos Apeitos, Jason T. Lemus, and Jeffrey M. Lotz	
<b>Disease Surveillance in Wild and Cultured Stocks of White Seabass (<i>Atractoscion nobilis</i>)</b>	<b>11</b>
Mark S. Okihiro	
Sebastes	
<b>Juvenile Mass Production of Black Rockfish (<i>Sebastes schlegeli</i>) in FRA Miyako Station: Present Status and Problems</b>	<b>21</b>
Masahiro Nakagawa, Junichi Adachi, Ken Shimizu, and Satoshi Shiozawa	
Paralichthys	
<b>Construction of a BAC Library from XY Japanese Flounder Using Frozen Sperm Genomic DNA</b>	<b>27</b>
Hiroyuki Okamoto, Hiroyuki Nagoya, Eiichi Yamamoto, Takashi Sakamoto, Kanako Fuji, Nobuaki Okamoto, Kazuo Araki, and Ichiro Nakayama	
Scombrids	
<b>Status of Pacific Bluefin Tuna (<i>Thunnus orientalis</i>) Seed Production in Amami Station of NCSE FRA</b>	<b>31</b>
Hideki Nikaïdo, Takayuki Takebe, Kentaro Ide, Hitoshi Imaizumi, Nobuhiro Tezuka, and Syukei Masuma	
<b>Genetics and Reproduction</b>	
<b>Visualization Tools to Probe Early Stage Fish Abnormalities</b>	<b>37</b>
Susumu Uji and Tadahide Kurokawa	
<b>Special Topics</b>	
<b>Airlift-PolyGeyser Combination Facilitates Decentralized Water Treatment in Recirculating Marine Hatchery Systems</b>	<b>43</b>
Ronald F. Malone and Sripavani Gudipati	
<b>Preparation of Marine Silage and its Potential for Industrial Use</b>	<b>51</b>
Motoharu Uchida	

<b>Special Topics (continued)</b>	
<b>Techniques for Live Capture of Deepwater Fishes with Special Emphasis on the Design and Application of a Low-cost Hyperbaric Chamber</b>	<b>57</b>
Jeffrey E. Smiley and Mark A. Drawbridge	
<b>A Preliminary Report on the Use of Porphyra Protoplast as a Food Substitute for Culturing Aquatic Animals</b>	<b>63</b>
Takao Yoshimatsu, Alok Kalla, Toshiyoshi Araki, Dong-Ming Zhang, and Shuichi Sakamoto	
<b>Aquaculture and Stock Enhancement Technologies Based on Recently Discovered Calcium-sensing Receptors in Finfish</b>	<b>69</b>
Steve Jury, H. William Harris, Timothy Linley, David Russell, Marlies Betka, Susan Anderson, Shinji Harakawa, and Akikuni Hara	
<b>Biological Studies on the Digestive Mechanism in Abalone</b>	<b>75</b>
Kentaro Niwa, Hideaki Aono, and Tomoo Sawabe	

## **Introduction**

The U.S.-Japan Cooperative Program in Natural Resources (UJNR) was established on January 29, 1964. Since its creation, the UJNR has evolved to become one of the oldest and most effective cooperative agreements between Japan and the United States. In 1969, the UJNR Aquaculture Panel was created as a vehicle for scientists of both countries to meet and discuss aquaculture research accomplishments, needs, and priorities, as well as provide opportunities for cooperative research and scientific exchange.

Under the auspices of the UJNR Aquaculture Panel, U.S.-Japan scientists have met annually since 1971 without interruption. The venue for these meetings has alternated between the two countries. In November 2005 the meeting (comprised of a business meeting, scientific symposium, and several field trips) was held at the Hubbs-SeaWorld Research Institute, San Diego, California, and nearby environs. The scientific symposium was coordinated by Mark Drawbridge of Hubbs Sea-World and Dr. Kenneth Leber of Mote Marine Laboratory, Sarasota, Florida. By prior agreement of the U.S.-Japan panels, contributors to the proceedings were requested to submit manuscripts in the form of extended abstracts.

**Yasuji Sakai, Japan**

**Robert Iwamoto, United States**



# **Current Situation of Technical Developments in Seed Production of Yellowtail (*Seriola quinqueradiata*) in Japan**

Keiichi Mushiake  
Headquarters, Fisheries Research Agency  
15th Floor Queen's Tower B  
2-3-3 Minatomirai, Nishi-ku, Yokohama  
Kanagawa, Japan, 220-6115  
mushiake@fra.affrc.go.jp

Hideki Yamazaki  
Yashima Station of National Center for Stock Enhancement  
FRA, Takamatsu  
Kagawa, Japan, 761-0111

Hiroshi Fujimoto  
Obama Station of NCSE  
FRA, Obama  
Fukui, Japan, 917-0117

**Keywords:** Yellowtail, *Seriola quinqueradiata*, seed production, broodstock management

## **Abstract**

The National Center for Stock Enhancement (NCSE, formerly Japan Sea-Farming Association), of the Fisheries Research Agency, introduced the stock enhancement program for yellowtail (*Seriola quinqueradiata*) in 1977. Technical developments in induced spawning as well as larval and juvenile rearing techniques have increased the production of this species to 1 million juveniles per year at NCSE. This project faced three major drawbacks: high mortality of larvae, cannibalism, and the smaller size of released juveniles in comparison with their wild counterparts. The high mortality of larvae was overcome by utilizing strong aeration during the early larval stages, while cannibalism was controlled by grading juveniles by size selection. The two-month delay in the spawning season of reared broodstock (the usual spawning season is late April to early May), which caused the smaller size of released juveniles, was solved by developments in advanced spawning techniques. Photoperiod and water temperature manipulations were used to produce eggs in February, thus producing yellowtail juveniles that can be released into the wild at a size similar to that of the wild stock.

## **Introduction**

Yellowtail (*Seriola quinqueradiata*), which is a large migratory species that moves north and south in waters adjacent to the Japanese archipelago, is an important species of the fishery stock in western Japan and the coastal areas of the Sea of Japan. In 2002, the annual catch was 50,000 tons and the aquaculture industry produced 140,000 tons. Because there is apprehension that the yellowtail stock may be reduced by capture of wild juveniles (called mojako) for aquaculture, yellowtail juveniles were chosen as a target species for sea ranching in 1977. Komame and Goto Stations of the National Center for Stock Enhancement (NCSE, formerly Japan Sea-Farming Association), of the Fisheries

Research Agency (FRA), started to develop the techniques for broodstock management of yellowtail in 1977. In 1978 Yashima and Kamiura Stations of NCSE started seed production of the species, followed by Goto Station of NCSE in 1981.

Yellowtail is a unique species distributed only near the coast of Japan. The major spawning ground is the south-central area of the East China Sea where the spawning season starts around February. In Shikoku and the northern part of Kyushu, it starts around April or May, so the season becomes later as one goes further north (Hamada and Mushiake, 2006).



## Brief history of seed production in yellowtail

Collection of eggs and culture of larvae and juveniles were started in order to obtain basic information in 1960. A marked decrease of catch quantity in 1970s led NCSE to begin the technical development for broodstock management in 1977 and seed production in 1978.

In NCSE, the brief history of the technical developments for yellowtail culture was as follows (Shiozawa and Yamasaki 2006):

1. 1977–1989. NCSE was engaged in seed production in large quantities, thereby enabling the production of one million juveniles in just one station by 1986.
2. 1990–1995. The technical developments focused on the quality of seed production, rather than quantity, through the introduction of formulated diets and developments in the improvement of survival rates during the early stages.
3. 1996–2005. Since 1996 advanced egg collection and early seed production techniques have been implemented.

In the present paper, some technical developments in seed production since 1990 are presented, as well as the details of both improvement techniques for survival in seed production and advanced spawning of broodstock.

## Improvement techniques for survival in seed production of yellowtail

The drawback of seed production for yellowtail was the high incidence of larval mortality that occurred during the early larval stages. Moreover, cannibalism was observed from when they reached a total length of about 15 mm until they grew to juvenile size. Those were the two major causes of mortality, and some measures have been taken to counteract the problems.

One approach was aeration which led to a high survival rate during the early larval stages. In the past, the sinking of hatched larvae, seen before and after the mouth opening stage, was a major problem leading to a high mortality (Shiozawa and Yamasaki 2006). With the conventional method, slight aeration was used during the early stages of rearing. The water in the tank was slightly up-welled vertically, though only locally in the tanks, leading to high mortalities due to the sinking of larvae. Since 1995, the problem has been eliminated by employing stronger aeration using air-block pipes set in each corner at the bottom of the tanks. This method enabled the tank water to have a stronger upwelling

current that prevented the larvae from accumulating at the bottom of the tanks. The method markedly increased the survival rate up to 10 days after hatching. Compared with the previous method, the survival rate at the early stage was increased from 21.7% to 58.1% in 1995 and from 14.6% to 57.4% in 1997.

The other problem was cannibalism. The best way to prevent cannibalism is to grade the juveniles (Shiozawa and Yamasaki 2006). When yellowtail reach 10 mm total length (TL), they go up to the surface at night, so grading is carried out during a single night when the fish reach around 15 mm TL, as that is the size when cannibalism is known to start. The floating, sleeping juveniles are siphoned out of the rearing tank and transferred to a net pen of 3 mm mesh size in another tank. Only individuals that couldn't pass through the mesh remain within the net thereby separating the fish into two size groups. Figure 1 shows the total length distribution in the large and small sized fish that were selected by this method. The fish were clearly divided into two groups at around 18 mm and the positive effects of selection are shown by the survival rate. This size selection at night has clearly doubled the survival rate, when compared to the nongraded fish. That is, according to size selection at 15 mm TL, the survival rate of 15–30 mm TL was improved from 33.8% to 78.9% in 1994 and from 24.4% to 52.1% in 1995. At present, survival rates of around 15% at 30 mm in TL are obtained. In exceptional cases, the survival rate can even reach up to 30%.

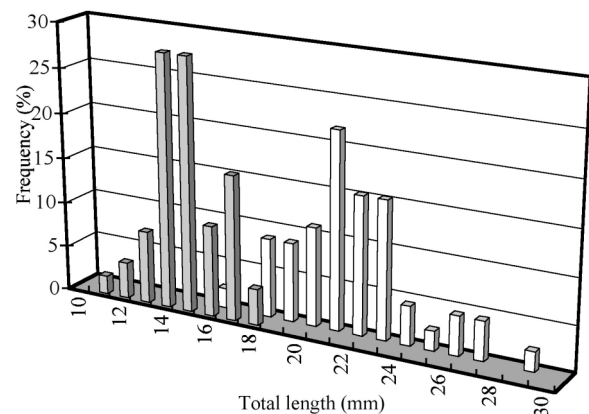

Figure 1. Size frequency (TL) of yellowtail larvae graded with a 3 mm mesh net at night when the fish averaged 15 mm TL.

### Advanced spawning of yellowtail broodstock

Broodstock of wild origin were reared in net cages and used for egg collection. Egg collection was mainly carried out from late April to early May until 1995 (Mushiake 1994). The collection was carried out after the broodstock were maintained at 19°C. When the oocyte diameter reached over 700 micrometers, the broodstock were injected with 600 IU/kg body weight with human chorionic gonadotropin (HCG). The procedure enables egg collection 48 hours after the hormone injection. The hormone should be injected when broodstock maturity is in the last phase of yolk deposition. About one million eggs were obtained. However, the size of hatchery-reared juveniles was much smaller than that of their wild counterparts that were caught during the same period because of a two month delay in the spawning season of reared broodstock. Therefore in 1996, in addition to the previous rearing methods for captive broodstock, a rearing environment that had short and long photoperiods and manipulated water temperatures was provided in order to induce earlier maturation. These manipulations were followed by HCG injection and spawning was successfully induced between February and March (Mushiake et al. 1994, 1998). Now eggs are available for seed production in the hatchery at the same time as the ones that are spawned naturally in the wild.

As shown in Figure 2, the growth of the hatchery-reared juveniles originated from the advanced spawning on February, as represented by closed circles, clearly showed that the juveniles had a similar size and almost the same growth as their wild counterparts, as indicated by open circles. In fact, the hatchery-reared juveniles were released with a brand mark into the Seto Inland Sea and collected at a fish market in December 1999. The body weight of the wild and the released fish was 1.2 kg and both types traded for the same price in the fish market. The seed production at present is capable of producing fish of a similar size to the wild stock by utilizing eggs obtained from advanced spawning in February (Fujimoto et al. 2006).

Thus far, the following technical developments were shown in the present study.

1. The methods of egg collection and seed production techniques were the optimal ones and solve the various problems faced in the past, so the techniques have been already established for yellowtail.
2. With regard to the advanced egg collection method during February and March, the

hatchery-reared juveniles that were produced by advanced spawning showed growth rates to their wild counterparts. These developed techniques were effective for the promotion of stock enhancement.

3. At present, yellowtail aquaculture depends on captured wild juveniles. However, there is a concern that a decrease in wild juveniles may have some adverse effect on the fundamental management of yellowtail aquaculture. According to our studies, there was no difference between yellowtail produced in advanced spawning and those hatched in the wild. The next challenge will be to utilize the hatchery seed of yellowtail for aquaculture purposes.

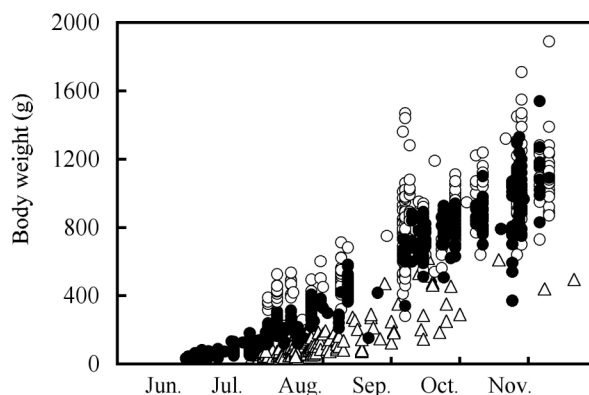

**Figure 2. Growth of hatchery-reared juvenile yellowtail originating from advanced spawning in February (closed circles) compared with wild spawned yellowtail (open circles).**

## References

- Fujimoto, H., H. Yamasaki, and A. Suda. 2006. Release for stock enhancement. *In* M. Matsuyama, Y. Hiyama, K. Mushiake, and H. Yoshiaki (eds.), *Biology, stock enhancement and aquaculture of buri [Japanese yellowtail (*Seriola quinqueradiata*)]*.
- Hamada, K., and K. Mushiake. 2006. Advanced spawning of yellowtail *Seriola quinqueradiata* as early as December by manipulations of both photoperiod and water temperature. *Nippon Suisan Gakkaishi*, 72(2):186-192.
- Mushiake K. 1994. Studies on technical development of broodstock management in striped jack and yellowtail. Doctoral thesis. Hiroshima University, Higashi-hiroshima.
- Mushiake, K., K. Kawano, W. Sakamoto, and I. Hasegawa. 1994. Effect of extended daylength on ovarian maturation and HCG-induced spawning in yellowtail fed moist pellets. *Fish. Sci.* 60:647–651.
- Mushiake, K., K. Kawano, K. Kobayashi, and T. Yamasaki. 1998. Advanced spawning in yellowtail, *Seriola quinqueradiata*, by manipulations of the photoperiod and water temperature. *Fish. Sci.* 64:727–731.
- Shiozawa, S., and H. Yamasaki. 2006. Seed production of juveniles. *In* M. Matsuyama, Y. Hiyama, K. Mushiake, and H. Yoshiaki (eds.), *Biology, stock enhancement and aquaculture of buri [Japanese yellowtail (*Seriola quinqueradiata*)]*.

# Culture of Spotted Seatrout (*Cynoscion nebulosus*) in a Closed, Recirculating System

Reginald B. Blaylock, Angelos Apeitos, Jason T. Lemus, and Jeffrey M. Lotz  
Gulf Coast Research Laboratory  
The University of Southern Mississippi  
P.O. Box 7000  
Ocean Springs, Mississippi 39566-7000  
reg.blaylock@usm.edu

**Keywords:** Spotted seatrout, intensive culture, recirculation, *Cynoscion nebulosus*, larviculture

## Abstract

The spotted seatrout (*Cynoscion nebulosus*) is the most popular sport fish among anglers in the estuarine and nearshore waters of Mississippi. In partnership with the Mississippi Department of Marine Resources, we have begun to evaluate the feasibility of using cultured spotted seatrout to supplement the natural stocks in Mississippi waters. Presently, culture of seatrout consists of captive spawning of broodstock and rearing of larvae in earthen ponds containing estuarine water and mixed wild zooplankton. We have designed a recirculating system in which to rear spotted seatrout larvae and juveniles intensively. As a test of the intensive culture system, approximately 80,000 spotted seatrout (2 day posthatch [PH]) larvae were obtained from Sea Center Texas in Lake Jackson. Larvae were stocked in eight, 1,000 L tanks at a density of 10 larvae/liter. Feed consisted of ss-rotifers (range 70-110  $\mu$ m), *Artemia* nauplii, and dry food. Mean survival from day 2 PH through day 25 PH was 25% and the larvae had a mean total length of 16.64 mm  $\pm$  0.79 mm and a mean weight of 0.04 g  $\pm$  0.01 g. Cannibalism commenced at day 7 PH. At day 24 PH the juveniles were transferred to a nursery system. At day 38 PH the fish were transferred to a larger 15 $\times$ 3.5 $\times$ 1 m, 55,000 L raceway. Survival during the nursery phase averaged 88.84%  $\pm$  5.80%. Larvae averaged 45.01 mm  $\pm$  1.93 mm and 0.79 g  $\pm$  0.10 g.

## Introduction

Worldwide, marine fish populations are declining. Current capture fisheries, while relatively stable over the last 15 years, may be unsustainable past the year 2040 (New 1997). Of the fish populations that have been assessed, more than 30% are currently overfished (Pew Oceans Commission 2003). In response to the growing problem, the Magnuson-Stevens and Sustainable Fisheries acts required that plans for management and restoration of overfished species be put in place. Typically, the plans include catch/size limitations or habitat restoration, but additional techniques to assist management agencies are needed.

Stock enhancement—the release of cultured fish into the wild—actually served as the technique of choice in marine fisheries management throughout most of the nineteenth and twentieth centuries. However, the lack of evidence of effectiveness combined with concerns over maladaptive behaviors, artificial genetic selection, and disease problems in cultured fish created skepticism about the desirability of the approach. The advent of new hatchery and tagging technologies, the continued decline of

managed stocks, and an accumulation of data from studies in Japan (Tsukamoto et al. 1989, Tsukamoto 1993), Norway (Svasand et al. 1990), and Hawaii (Leber 1995) inspired Blankenship and Leber (1995) to revive the idea that successful marine stock enhancement is possible through carefully planned research that incorporates principles of fish culture, ecology, health, genetics, and assessment.

The spotted seatrout (*Cynoscion nebulosus*) is an estuarine and nearshore species ranging from New York to Texas (Robins and Ray 1986). In the southeastern U.S. and in the Gulf of Mexico, the spotted seatrout is widely esteemed among recreational anglers. In Mississippi waters, the spotted seatrout is the premier sport fish. However, increasing human population places pressure on marine fisheries resources through habitat destruction and demand for food and recreation. The popularity of seatrout, combined with its dependence on threatened inshore habitats, make it potentially vulnerable to depletion. It is from this perspective that the Gulf Coast Research Laboratory in cooperation with the Mississippi Department of

Marine Resources and recreational angler Organizations founded SPEC, the Seatrout Population Enhancement Cooperative, a program to determine whether stock enhancement is a feasible option for management of spotted seatrout in Mississippi.

In this paper, we present the framework of the program we developed for the intensive rearing of spotted seatrout for stock enhancement in Mississippi waters.

### **Seatrout culture**

The culture of seatrout is not new. Wild seatrout juveniles were stocked into brackish ponds with mixed results as early as the 1940s (Colura et al. 1992). Colura (1974) first described induced spawning of spotted seatrout. Arnold et al. (1976) and Taniguchi (1981) described methods for spawning and rearing spotted seatrout in the laboratory. Colura et al. (1976) and Tucker (1988) described experimental methods of fingerling production for spotted seatrout. Although Arnold's original production system included early larval rearing in which he achieved as high as 30% survival through 30 days, his system evolved into the extensive pond culture approach described in Colura et al. (1992) whereby prefeeding larvae are introduced into brackish water ponds containing wild, mixed zooplankton. Part of the reason for transitioning to pond rearing was inconsistent and low yields in laboratory experiments. Colura's extensive system produced an average survival of 28.7% over 20–30 days of rearing (Colura et al. 1992). The Texas Department of Parks and Wildlife currently uses a variation of this method to produce approximately 3 million 30-day-old larvae annually. Since 1993 Texas has released approximately 35 million 30-day-old juvenile seatrout (David Abrego, personal communication).

In coastal Mississippi, which is estuarine, pond culture is not feasible for a variety of reasons, including the highly variable salinities, the lack of available space, and the shallow water table. Thus our program has focused on intensive tank culture. As a result, the process is more complex and labor intensive than pond rearing; however, preliminary results suggest that the process produces a result at least as good as extensive culture.

### **Mississippi program**

Our program focuses on five primary objectives: 1) broodstock development—the development of technology for capturing, transporting, quarantining

and maintaining broodstock; 2) Spawning—the development of methods for conditioning healthy broodstock for natural spawning in captivity; 3) culture—the development of methods to maximize production of fish that can be tagged for release in intensive, indoor recirculating systems; 4) tag and release—the development of technology to efficiently and reliably tag and release juveniles; and 5) postrelease assessment—the development of methods to monitor juveniles after release and analyze the information to assess the effectiveness of the program.

**Broodstock development.** Broodstock development is patterned directly after the Texas Parks and Wildlife program (David Abrego, personal communication). Wild animals are caught locally on hook-and-line using barbless hooks. Seatrout are delicate animals and must be handled with great care. Soft catch-and-release nets or standard nets lined with plastic are required for landing the fish. Fish are transferred from the hook into holding pens that serve as a reservoir to contain all fish caught during a collecting event. Upon completion of the collecting event, fish are transferred using the plastic-lined nets into hauling tanks for transport to the lab. Stress Coat and supplemental oxygen are added to the hauling tank. It is important to note that at no point during this process are the fish removed from the water. The population structure of seatrout in Mississippi is not yet known, so until we evaluate the population structure, we assume animals from the Pascagoula River, the Biloxi Bay area, and Bay St. Louis are distinct populations.

Upon arrival at the laboratory, fish are placed in a staging area that allows acclimatization and recovery from the stress of capture and transport. After a brief acclimatization period, fish enter the quarantine area. Because our goal is to maintain fish in optimal condition for long-term holding and because all wild fish have parasites, we initially quarantine the fish to eliminate diseased fish and parasites that are likely to cause problems in captivity (i.e., parasites with direct life cycles). We practice standard animal care facility sanitation practices such as access control, hand/foot/equipment disinfection, and barrier protection after the quarantine period.

**Quarantine.** Quarantine consists of three stages. First, fish enter pretreatment to remove ectoparasites. Pretreatment consists of two steps, a 5 minute freshwater dip that detaches many of the ectoparasites, particularly *Amyloodinium ocellatum*,



followed by a 24 hour treatment with Praziquantel (2.5–5.0 mg/l) to rid the fish of dangerous monogeneans. Following pretreatment, fish enter primary quarantine in a 12,000 L raceway for a minimum of 10 days, during which they are observed for health problems (and treated if necessary) and transitioned to frozen food. Seatrout are slow to begin feeding in captivity, so after a few days of isolation we slowly introduce live, laboratory-reared shrimp. Once the fish begin to eat the live shrimp, frozen shrimp are added. Eventually, frozen squid are added. Ten to 14 days after entry into primary quarantine, the fish are treated with formalin (175 mg/L for 60–90 min) to remove any residual ectoparasites. After formalin treatment, the fish enter the third stage—secondary quarantine—where they are observed and retreated as necessary for an additional 20 days.

**Maturation.** After quarantine, fish enter the maturation facility. During the move, the fish are anesthetized, weighed, measured, sexed, tagged according to sex, and fin clipped for DNA analysis. Fish are stocked into 12,000 L circular tanks fitted with egg collectors in a temperature and photoperiod controlled environment. Water quality is maintained using a suspended trickle bioball biofilter, sand filter, coral filter, protein skimmer, and ozonation unit. Each tank is stocked with 20 fish, ideally in a 1:1 sex ratio. The fish are fed a combination of shrimp, squid, and cigar minnows at 3% of body weight three times per week using the Texas Parks and Wildlife protocol (David Abrego, personal communication). The ratio of shrimp, squid, and cigar minnows varies depending on season. During spawning, animals are fed shrimp ( $\approx 36\%$ ), squid ( $\approx 45\%$ ) and cigar minnows ( $\approx 18\%$ ). Postspawning animals are fed at the same rate a diet consisting of approximately 16% shrimp, 42% squid, and 42% cigar minnows. The temperature and photoperiod cycle mimics the natural cycle, but is condensed to 150 days based on the Texas Parks and Wildlife protocol to provide quick turnaround or off-season spawning.

**Larviculture.** Our larviculture system is a modification of the combined experiences reported in Arnold et al. (1976), Taniguchi (1981) and Tucker (1988) as well as the literature on the culture of other marine fishes including the red snapper (Ogle and Lotz 2005). Seatrout spawn at night. The eggs are buoyant and are carried with the current out of the tank into an egg collector where they are retained. From the egg collector they are placed in a conical incubator and agitated with air. Viable eggs float,

and upon hatching ( $\approx 48$  hours) the larvae are placed at a density of 10/L in 1,000 L larval rearing tanks previously stocked with 50,000 cells/ml of live Tahitian strain *Isochrysis galbana*. Beginning on day 2 posthatch (PH), enriched ss-rotifers at 10/ml and cultured copepod nauplii at 0.5–1.0/ml are added. On day 7 PH enriched brine shrimp nauplii are offered at 1/ml. Copepods are discontinued on day 8 PH and rotifers are discontinued on day 9 PH. Brine shrimp are increased to 2/ml on day 10 and to 4/ml on day 13 PH. Sprinkles of dry, size-00 mash are offered beginning on day 15 PH and the amount is slowly increased over time. Brine shrimp are decreased to 2/ml on day 18 PH. Dry, size-0 crumble concurrent with 00-mash begins to be offered on day 20 PH and size-1 crumble is added to the mixture on day 23 PH. Harvest to the nursery occurs on days 24 and 25 PH. Of the larvae stocked into the system, we achieved approximately 25% survival through day 24 PH.

**Nursery phase.** Trout are typically released into ponds after the initial culture period; thus, protocols for seatrout nursery operations are largely experimental, particularly for large-scale production. Our system is based on that used in our red snapper culture operation (Ogle and Lotz 2005) and consists of fourteen, 1,000 L tanks equipped with adjustable spray bars. Cannibalism began on day 7 of the study. By day 24, cannibalism was a significant source of mortality. We did two things in the nursery to try and minimize the problem. First, we used the adjustable spray bars and pumps to create currents sufficient to keep the juveniles active. Second, we manipulated the density. Not all species respond to changes in density in the same manner (e.g., Kestemont et al. 2003) and the response of seatrout was unknown. Thus we initially stocked at three different densities (four tanks at 0.8 fish/L, four at 1/L, four at 1.5/L, and two at 3.5/L). Initially, size-1 crumble was slowly sprinkled into the tanks to acclimatize the fish, but food level was increased to 3% body weight per day based on the average weight of a sample of juveniles going into the nursery. Originally, the nursery phase was intended to last for at least 14 days, however concerns over our ability to maintain water quality in the high density tanks led to harvesting at day 10 of the study ( $\sim 35$  days PH). We achieved an average of 88.8% survival (range of 79.8–95.7%), and although the average survival was lower in the high density tanks (82.4%), the variability was such that we can not summarily exclude a high density nursery as an option for future batches of juveniles. Although fish stocked at the highest density were smaller than those stocked at

other densities, major size discrepancies within tanks were not observed.

**Growout.** Growout for this batch was accomplished in a 15×3.5×1 m rectangular raceway (approximately 50,000 L capacity), equipped with suspended trickle bioblock biological filters, sand filters and a protein skimmer. Fish were fed progressively larger pellets at approximately 3% body weight based on periodic samples. All fish died at approximately day 60 PH during hurricane Katrina. The juveniles were approximately 80–100 mm, and we estimated approximately 75% survival to day 60. There was more size variability than in the nursery, perhaps due to unequal access to food created by poor circulation in the raceway.

**Tagging and release.** At the time of the hurricane, plans for experimental tagging with coded-wire and elastomer tags to assess handling and insertion procedures, tag placement, and tag retention were being developed. Acoustic tags will be explored in the future. Growth rates and feed conversion ratios were being monitored. We anticipate that release procedures will involve a fish pumping device like those widely used in the aquaculture industry for stocking and harvesting netpens.

Seatrout are known to vary genetically among localities (Gold et al. 2003, Wiley and Chapman 2003), thus, the test group of juveniles from Texas could not have been released in Mississippi. A project to assess genetic differences among fish from different localities in Mississippi is in development to provide information critical to the development of a sound release strategy. Until that information is available, we restrict ourselves to releasing juveniles only in the area from which the broodstock were acquired. Initial issues addressed by the release will include survival after release, percent recovery, and movement. More complicated issues such as the effect of size-at-release and time of release will be addressed in the future.

## References

- Arnold, C. R., J. L. Lasswell, W. H. Bailey, T. D. Williams and W. A. Fable, Jr. 1976. Methods and techniques for spawning and rearing of spotted seatrout in the laboratory. Proc. Annu. Conf. Southeast Assoc. Fish Wildl. Agencies 30:166–178.
- Blankenship, H. L., and K. M. Leber. 1995. A responsible approach to marine stock enhancement. Am. Fish. Soc. Symp. 15:167–175.
- Colura, R. L. 1974. Induced spawning of the spotted seatrout, *Cynoscion nebulosus* (Cuvier). Proc. World Maricul. Soc. 5:319–330.
- Colura, R. L., B. T. Hysmith, and R. E. Stevens. 1976. Fingerling production of striped bass (*Morone saxatilis*), spotted seatrout (*Cynoscion nebulosus*), and red drum (*Sciaenops ocellatus*) in saltwater ponds. Proc. World Maricul. Soc. 7:79–92.
- Colura, R. L., T. L. King, J. D. Gray and B. W. Bumguardner. 1992. Analyses of six years of spotted seatrout (*Cynoscion nebulosus*) pond culture trials. Aquaculture 107:313–332.
- Gold, J. R., L. B. Stewart, and R. Ward. 2003. Population structure of the spotted seatrout (*Cynoscion nebulosus*) along the Texas gulf coast, as revealed by genetic analysis. In S. A. Bortone (ed.), Biology of the spotted seatrout, p. 17–29. CRC Press, Boca Raton, Florida.
- Kestemont, P., S. Jourdan, M. Houbart, C. Melard, M. Paspatis, P. Fontaine, A. Cuvier, M. Kentouri, and E. Baras. 2003. Size heterogeneity, cannibalism, and competition in cultured predatory fish larvae: Biotic and abiotic influences. Aquaculture 227:333–356.
- Leber, K. M. 1995. Significance of fish size-at-release on enhancement of striped mullet fisheries in Hawaii. J. World Aquacult. Soc. 26:143–153.
- New, M. B. 1997. Aquaculture and the capture fisheries: Balancing the scales. World Aquacult. 28(2):11–30.
- Ogle, J. T., and J. M. Lotz. 2006. Characterization of an experimental indoor larval production system for red snapper. N. Am. J. Aquacult. 68:86–91.
- Pew Oceans Commission. 2003. America's living oceans: Charting a course for sea change, recommendations for a new ocean policy, May 2003.
- Robins, C. R., and G.C. Ray. 1986. A field guide to Atlantic Coast fishes of North America. Houghton Mifflin, Boston, Massachusetts.

Svasand, T., K. E. Jorstad, and T. S. Kristiansen. 1990. Enhancement studies of coastal cod in western Norway, part 1, recruitment of wild and reared cod to a local spawning stock. *J. Cons. Int. Explor. Mer.* 47:5–12.

Taniguchi, A. K. 1981. Survival and growth of larval spotted seatrout (*Cynoscion nebulosus*) in relation to temperature, prey abundance, and stocking densities. *Rapp. P-V Reun. J. Cons. Int. Explor. Mer.* 178:507–508.

Tsukamoto, K. 1993. Marine fisheries enhancement in Japan and the quality of fish for release. *Eur. Aquacult. Soc. Spec. Publ.* 19:556.

Tsukamoto, K., H. Kuwada, J. Hirokawa, M. Oya, S. Sekiya, H. Fujimoto, and K. Imaizumi. 1989. Size-dependent mortality of red sea bream, *Pagrus major*, juveniles released with fluorescent otolith-tags in News Bay, Japan. *J. Fish Biol.* 35(Supplement A):59–69.

Tucker, J. W., Jr. 1988. Growth of juvenile spotted seatrout on dry feeds. *Prog. Fish-Cult.* 50:39–41.

Wiley, B. A., and R. W. Chapman. 2003. Population structure of the spotted seatrout, *Cynoscion nebulosus*, along the Atlantic coast of the United States. *In* S. A. Bortone (ed.), *Biology of the spotted seatrout*, p. 31–40. CRC Press, Boca Raton, Florida.



# **Disease Surveillance in Wild and Cultured Stocks of White Seabass (*Atractoscion nobilis*)**

Mark S. Okihiro  
California Department of Fish and Game  
4065 Oceanside Blvd., Suite G  
Oceanside, California 92056  
ms.okihiro@att.net

**Keywords:** white seabass, *Atractoscion nobilis*, fish, infectious, disease, survey, aquaculture

## **Abstract**

Success of the Ocean Resources Enhancement and Hatchery Program (OREHP) in California has been due, in part, to a comprehensive disease surveillance program geared toward rapid detection of a wide range of infectious and parasitic diseases afflicting both wild and cultured stocks of white seabass (*Atractoscion nobilis*). Isolation and identification of white seabass (WSB) pathogens is accomplished via a number of proven diagnostic methodologies including necropsy, cytology, histology, electron microscopy, microbiology, serology, and polymerase chain reaction assays. For WSB, major pathogens of concern are: viral nervous necrosis virus (VNNV), *Piscirickettsia salmonis*, and an as yet uncharacterized herpes virus. Use of an effective disease surveillance program has helped ensure that hatchery epizootics are detected in a timely fashion, and that treatment is appropriate and efficacious. Since OREHP is a stock enhancement program, there is an additional goal of minimizing disease transfer from cultured to wild fish.

Disease outbreaks are inevitable with intensive culture; the key is determining which pathogens pose acceptable risks to wild stocks. The most dangerous pathogens are lethal and highly contagious; the worst are novel pathogens to which wild WSB have no immunity. Avoiding introduction of novel pathogens requires determining which diseases occur naturally. A broad sampling of wild populations can determine normal pathogen load and exposure level. The most efficient method of wild fish evaluation is to determine serum antibody levels to specific pathogens using enzyme-linked immunosorbent assays (ELISAs). ELISAs have allowed OREHP to make informed decisions regarding enhancement efforts in California. ELISA results have demonstrated that exposure to VNNV is widespread among wild WSB. Those data give OREHP the option of releasing VNNV-exposed, but healthy, WSB without fear of unleashing a new plague into native stocks. In contrast, exposure to *P. salmonis* has not been conclusively demonstrated among wild fish, and that novel disease requires a strict discover-and-euthanize approach when found in cultured fish.

## **Introduction**

White seabass (*Atractoscion nobilis*) belong to the family Scianidae and are one of the largest croaker species found in the Pacific Ocean. The primary host range is from Point Conception, in Central California, south through Baja, Mexico. Historically, the fish has been found as far north as Alaska (Eschmeyer and Herald 1983). White seabass (WSB) have a maximum size of approximately 40 kg and have an estimated lifespan of more than 30 years. WSB are a popular commercial and recreational fish species, with peak catches of 50,000 to 65,000 fish per year from sport boats (commercial passenger fishing vessels) alone in the late 1940s. Beginning in the early 1950s, catches from both recreational and commercial fishermen started to decline dramatically. The fishery was essentially nonexistent by the late 1970s.

In response to the collapse of wild stocks, the Ocean Resources Enhancement and Hatchery Program (OREHP) was formed in 1983. OREHP is a cooperative effort between the California Department of Fish and Game (CDFG), Hubbs-SeaWorld Research Institute (HSWRI), several California public utility companies, and a number of volunteer organizations. The primary goal of OREHP is to help restore marine fish populations in California waters. OREHP works actively to culture several marine finfish species, but the major focus of remediation efforts is on WSB; WSB are currently the only cultured marine fish being released into California waters. As part of the OREHP program, a dedicated marine fish hatchery was constructed in 1995. The Leon Raymond Hubbard Jr. Marine Fish Hatchery (also known as Carlsbad Hatchery), located



in Carlsbad, California, has produced more than 100,000 juvenile WSB for release into the Pacific in each of the past five years. The record year was 2004 when the hatchery released more than 270,000 fish, either directly from the hatchery, or from one of 14 growout/netpen facilities located throughout Southern California.

The release number for 2005 was expected to be only half that of 2004. The primary reason for the reduced number is that 2005 was one of the worst years for diseases since the hatchery was constructed. *Flexibacter maritimus* and disseminated *Vibrio* epizootics occurred at the hatchery and four netpen sites. Piscirickettsiosis, which is a lethal rickettsial disease caused by viral nervous necrosis virus (VNNV) (*Piscirickettsia salmonis*), was confirmed at one netpen site and was investigated at another. Gill flukes (*Anchoromicrocotyle guaymensis*) plagued four netpen sites. As of November 2005, there was a severe herpes virus outbreak at the Carlsbad Hatchery involving more than 50,000 WSB. There is no single reason for the increased number and severity of disease outbreaks that year, but the 2004–2005 winter was one of the wettest on record for California, and water quality early in 2005 was marginal at best with wide fluctuations in temperature, salinity, and particulate loads. Although no specific testing was done, contaminant loads (i.e., xenobiotics and bacteria) from rainwater runoff were assumed to be high throughout Southern California.

Disease outbreaks are an unfortunate, and sometime inevitable, consequence of almost all high-density marine aquaculture and finfish enhancement programs. To maximize mitigation efforts, while at the same time minimizing disease impacts to both cultured and wild fish, OREHP uses a three pronged approach: 1) a comprehensive biosecurity program, 2) health inspections of cultured fish, and 3) wild fish disease surveillance. Biosecurity protocols are geared toward disease prevention and limiting the spread and impact of diseases when they occur. Biosecurity is a key component of any aquaculture operation, but is not discussed here. Health inspections are the second component of OREHP's overall disease prevention program; all cultured fish are thoroughly evaluated prior to release. At a minimum, cultured WSB are inspected twice. The initial health check is done at the hatchery prior to transport to net pen facilities; the second check is done at the net pens just prior to fish being released into the Pacific. Additional health assessments are done as needed if fish are behaving abnormally or if there is an increase in daily mortality.

The third arm of OREHP's health assessment and disease prevention program is an ongoing effort to survey wild stocks of marine fish species—with special emphasis on those species targeted for mitigation or aquaculture. The goal of this disease assessment survey is to determine which pathogens and diseases are naturally occurring among wild marine fish stocks. This baseline information is critical if we are to avoid releasing lethal pathogens into potentially naïve populations of wild marine fish.

### **Finding a Competent Fish Pathologist**

One of the most important steps in any aquaculture venture or finfish enhancement program is locating a qualified and experienced fish pathologist. Fish pathologists can have either a veterinary or fisheries background, but should be qualified in the diverse array of subjects required for disease prevention, detection, control, and management. Some of the required fields of expertise (or at least familiarity) include: general biology, marine biology, fish diseases, general pathology, fish pathology, cytology, hematology, serology, histology, histopathology, general anatomy, fish anatomy, and molecular biology. Some background in toxicology, microbiology, fish physiology, surgery, and genetics is also helpful.

While finding a fish pathologist with a comprehensive and diverse educational background is important, equally important is finding one with extensive practical experience with a variety of fish diseases (infectious and noninfectious) in a variety of fish species. Ideally, experience should be with large groups of fish (i.e., herd health) and with managing problems associated with outbreaks of highly contagious diseases among high-density populations.

The ideal fish pathologist would be one who is already familiar with the particular fish species in use. However, because many remediation efforts involve marine fish species being cultured for the first time, this is usually not possible. The next best approach is to hire a person with sufficient flexibility that he or she can adapt his or her training and experience to the species at hand and to the unique disease problems associated with that species. Eventually, given sufficient time and examination of a sufficient number (i.e., hundreds to thousands) of diseased fish, almost any qualified fish disease specialist can become experienced with a given fish species.

Once the appropriate fish disease expert is located and gains experience with the particular fish species being cultured, the next major hurdle is to

ensure that this disease knowledge base (often painstakingly acquired over a period of years) is not lost when the fish pathologist leaves, retires, or gets eaten by a shark while diving. Knowledge transfer to the next pathologist can be simplified by 1) having a comprehensive and detailed file of pathology reports, 2) having detailed written protocols for most (if not all) of the tasks involved with disease diagnostics, prevention, and control, and 3) having an extensive photographic record for all of the major diseases encountered in that particular species. Photos should include gross photos of necropsy findings; wet mount cytology photos, light micrographs of histologic lesions, as well as transmission electron micrographs of ultrastructural lesions and pathogens. A comprehensive and well-organized photographic record of diseases, for a given fish species, will go a long way in bridging the knowledge gap for the next fish pathologist.

### **Diagnostic Approach**

The diagnostic approach used by OREHP includes five major components: 1) history and background information, 2) clinical assessment of live fish, 3) necropsy and gross examination, 4) sample selection, storage and transport, and 5) sample analyses using a variety of diagnostic assays.

**History and background information.** Obtaining a thorough history is the first step in obtaining a reliable diagnosis. Background information should include specifics on the species, age, size, and number of fish involved. If the fish are at a growout facility, it is important to determine from what part of the hatchery the fish originated and how they were transported. The number of transport trips that were needed, as well as any problems encountered during transport, are also important pieces of information. Daily mortality (both raw numbers and percentage of the population) and mortality patterns over the preceding two weeks are important indicators of health, as are feeding rates and patterns. Some OREHP pen operators feed by hand, which gives them a good opportunity to observe their fish, assess feeding rates, and evaluate overall condition and health. Information with respect to tank or pen maintenance is also helpful. Breakdown of mechanical equipment can obviously impact water quality and fish health. Consistent vacuuming of tank bottoms and cleaning of end screens are the primary maintenance items to look for. Inconsistent care—because of personnel shortages or sickness—should also be looked for and noted. The majority of

growout facilities have logbooks, which can be accessed to determine if pen maintenance was consistent and if there were problems with either mechanical systems or volunteers.

Water quality is the final item to check. Major water quality parameters that can affect fish health and influence disease outbreaks are: 1) temperature, 2) dissolved oxygen, 3) xenobiotic contaminant spills, and 4) red tide events (dinoflagellate plankton blooms). Marked temperature fluctuations (those  $>3^{\circ}\text{C}$ ) that occur over a short period of time (hours to days) often precede outbreaks of infectious disease.

**Clinical assessment.** Knowledge of normal behavior for the fish species, age group, and enclosure is important if deviations from the norm are to be detected. With WSB, it is important to know how the different age groups (larvae, juvenile, subadult, and adult) act when they are in round versus rectangular tanks, concrete raceways, fiberglass raceways, or netpens. Do fish school? At what age do they school? In what types of enclosures do they school? Are fish normally up near the surface, in the middle of the water column, or near the bottom? Answers to all of these questions are important to define what is normal behavior for a given species, age group, and tank setup. This knowledge can only be acquired over time, so it is always important to take the time to observe living fish in both sickness and health. Some general clinical signs to look for in unhealthy fish are: 1) weight loss (head out of proportion to the body), 2) anorexia (sick fish rarely feed), 3) lethargy (sick fish swim slowly) and absent or reduced escape reflex, 4) weakness (sick fish are pushed towards end screens or pulled towards drains), and 5) abnormal pigmentation (sick fish are usually darker than normal).

In addition to these nonspecific signs of disease, there are other more specific clinical indicators of ill health. With WSB, even heavily parasitized fish rarely flash (i.e., attempt to scratch themselves on fixed objects). Still, when flashing is observed, it is wise to check for external parasites. Terminal spinning or spiraling in juvenile WSB is usually associated with herpes virus gastroenteritis. A variety of cutaneous and ocular lesions can also be observed among a group of fish and will help indicate which fish should be selected for necropsy and which diseases are most likely to be encountered. For example, with WSB, mottled skin pigmentation is often indicative of *Ichthyobodo* infestation, while focal white areas of depigmentation are characteristic of *P. salmonis*. There is never 100% uniformity with respect to the clinical presentation, but with careful

observation, patterns will usually emerge and will help indicate from what the majority of fish are suffering.

**Necropsy.** A thorough necropsy is the most important step in determining why fish are dying. A good necropsy, performed by an experienced pathologist, will often quickly reveal what disease is involved and what the specific etiologic agent is. A well-executed necropsy is also the cheapest, most cost efficient means of making the right diagnosis.

Of course, necropsy results are only as good as the fish that are examined, so proper selection of the appropriate fish is critical. Live moribund fish are always preferable to dead fish, fresh dead is preferred to a fish that has been dead for several hours, and a dead fish several hours old is preferable to one that has been frozen. A good pathologist will always select his or her own fish to examine because for the uninitiated, all sick fish generally look alike. A good pathologist will select fish for necropsy based on specific clinical findings after observing fish *in situ*.

If obvious moribund fish are not available, then fish should be caught from areas where sick fish congregate. In concrete raceways, this means toward the back, near endscreens. With fiberglass raceways, this means checking the corners, and with circular tanks with center standpipes and drains, it means checking the middle of the tank. The number of fish to necropsy is variable, but the OREHP standard is to sample six fish per group. The number of fish sampled may be as few as four, if the cause of disease is obvious, or as many as 400, if there is need for a large number of different diagnostic assays.

Moribund WSB are euthanized with MS222 (tricaine methane sulfonate). Total length (TL) and standard length (SL) are taken in centimeters; determining wet body weight (in grams) is optional. If a blood sample is required, it is taken prior to or immediately following euthanasia. The gross external exam is the next step and involves careful assessment of the skin, fins, gills, pseudobranch, oral cavity, tongue, and eyes. The skin and fins are checked for irregular pigmentation, erosion, and ulcers. The gills and pseudobranch are assessed for color, filament damage, and parasites. The oral cavity and tongue are checked for parasites, lesions, and deformities. Deformities of the maxilla and mandible are relatively common among some groups of WSB. The eyes are evaluated primarily for evidence of emphysema associated with exposure to gas supersaturation. Following the gross external exam, scrapings are taken from the gills and skin for cytological assessment of parasite and bacterial loads.

For the gross internal exam, the fish is placed in right lateral recumbency (i.e., right side down, head to the left). The entire left abdominal body wall is removed with blunt/blunt tipped scissors to avoid puncturing the swim bladder and to avoid lacerating gonad or liver. Once the abdomen is open, the gonad is examined to determine sex. Almost all WSB >12 cm TL can be sexed grossly. After sex is determined, the heart, left liver lobe, pyloric caecae, stomach, and swim bladder are examined. The left liver lobe and stomach are then reflected ventrally to expose the spleen, intestinal tract, right liver lobe, gall bladder, and endocrine pancreas. The last step is to pull the swim bladder away from the spine and to examine the head, trunk, and tail kidney.

For the majority of cultured WSB, the brain and otoliths are not examined during routine health checks. Brains are dissected and sampled only when hatchery fish exhibit neurologic signs, have suffered cranial trauma, or when viral nervous necrosis (VNN) is suspected. For wild WSB, otoliths are routinely sampled for age assessment, and brains are frequently removed for VNN evaluation. The dissection is made by using a hacksaw with a metal cutting blade to make a frontal section above the eyes to access the brain dorsally. If the initial cut is not deep enough, the cranial vault can be further opened with a scalpel or razor blade. The brain is removed by using fine scissors to sever the olfactory lobes, cranial nerves, and then the spinal cord. Otoliths are located in the semicircular canals located below the brainstem.

### **Sample Collection, Storage, Transport, and Analyses**

OREHP employs a diverse array of diagnostic methodologies including cytology, histology, electron microscopy (EM), microbiology, polymerase chain reaction (PCR) assays, and enzyme-linked immunosorbent assays (ELISAs). Proper sample collection and handling, prior to analyses, ensures that the maximum amount of information will be obtained.

**Cytology.** Wet mount cytology is used for the diagnosis of many common bacterial and parasitic infections in WSB. Cytological samples include gill and skin scrapings and occasional squash preparations used to assess nodular masses. Gill and skin scrapings are collected using a dull scalpel to minimize cutting into deeper tissues; the goal is to scrape parasites and bacteria off target surfaces. For gills, samples of filament tissue are collected from

the first or second gill arch. With skin samples, the base of the left pectoral fin is initially scraped, followed by a pass along the skin below the dorsal fin. Small (1–2 mm<sup>3</sup>) samples of skin and gill are transferred onto glass slides and spread into a thin layer by applying a glass coverslip. Coverslipped samples are examined immediately via dark field light microscopy for parasites and bacteria.

The usefulness of the exam is dependent on how long the fish has been dead, when the sample was taken, and the thickness (between the slide and coverslip) of the sample. Ideally, samples are taken as soon as possible after the fish has died and examined as soon as possible after the slide has been prepared. If a fish has been dead for too long, and the fish remains in water, the offending parasites may leave the body. If a fish has been dead for too long, and the fish remains out of water, the offending parasites may be obscured by excess skin or gill mucus, or may have died and be difficult to locate.

Squash preparations are typically used to examine focal nodular lesions in parenchymal organs such as liver or kidney. Squash preps are also used to determine etiologies of ocular infections. Squash preps are made by excising a small (1 mm<sup>3</sup>) piece of the mass, with a scalpel and crushing it between a glass slide and coverslip. For dry lesions, a small drop of clean seawater can be included prior to adding the coverslip.

Both squash preps and skin scrapings are examined via light microscopy using a standard binocular microscope (Nikon Labophot) and dark field/phase contrast condenser. For WSB, the dark field condenser is almost exclusively used for wet mount preparations. The best wet mount preparations are thin (<30 µm between the slide and coverslip). Thin preparations allow clear visualization of bacteria and smaller protozoa. Thicker preparations (e.g., those with large scales or particulates) are suitable for large parasites (e.g., flukes), but make identifying bacteria difficult or impossible. The majority of marine finfish pathogens are motile, so examining slides quickly will allow location and identification of parasites by focusing the search on movement.

**Histology.** Histology is employed when necropsy and or cytology fails to provide a diagnosis, or when confirmation of a gross diagnosis is required or desired. Histology allows the extent of tissue damage to be determined and results in a permanent record for a disease or pathogen. Histology has good application for larval fish as almost all major organs, for multiple fish, can be examined on a single slide.

Histology is also a faster and cheaper diagnostic alternative for some viral infections (e.g., VNN) and rickettsial pathogens (e.g., *P. salmonis*).

For histology to be effective, a key factor is to obtain samples as quickly as possible after euthanasia or natural death. Autolysis, from bacterial or host enzymes, and bile, will rapidly degrade organs and tissues, making interpretation difficult or impossible. For WSB, 10% formalin is routinely used as a fixative. Samples are handled as carefully as possible to minimize crushing artifacts and to preserve normal architecture. Samples from larger parenchymal organs are cut with Teflon-coated razor blades to a thickness of 1 cm (or thinner) to ensure rapid and thorough fixation. A 10:1 ratio of formalin to tissue is used. Larval fish <1.5 cm TL are fixed whole. For larval and small juvenile fish >1.5 cm TL, the abdominal cavity is opened prior to fixing the entire fish. For large juvenile and subadult WSB, the gall bladder is carefully removed and either discarded or fixed in a separate container.

Formalin-fixed tissues are trimmed with a razor blade, placed in 4.0 cm by 2.8 cm plastic cassettes, and submitted to a commercial laboratory (Central Histology Facility in Sacramento, California) for routine paraffin processing. Tissue sponges are used with smaller larvae to prevent fish from slipping through slots in cassettes and being lost during processing. Embedded tissues are sectioned at 5–7 µm; sections are mounted on glass slides and stained with hematoxylin and eosin (HE). All HE slides are evaluated in house by the OREHP fish pathologist. Slides are assessed to determine which organs are affected, number and types of lesions, lesion severity, and presence of microbial pathogens. If etiologic agents are not readily apparent, special stains may be ordered and HE slides may be sent out for review by other fish pathologists.

**Electron microscopy.** EM is used to confirm the identity of known WSB viral and rickettsial pathogens, and to help identify and classify new microbial pathogens. For transmission electron microscopy (TEM), samples are taken from freshly euthanized fish. TEM samples are trimmed to 1 mm<sup>3</sup> cubes with Teflon-coated razor blades, and immersion fixed in chilled Karnovsky's solution. Fixed samples are stored at 4°C prior to processing. In cases where samples were not fixed in Karnovsky's, TEM samples can be obtained from either formalin-fixed material or from paraffin histology blocks. Formalin-fixed material is transferred to Karnovsky's, while paraffin-processed material is excised from blocks using scalpel blades,

and deparaffinized prior to processing. Karnovsky's-fixed tissues are processed and embedded in epoxy resin, sectioned at 1  $\mu\text{m}$ , and stained with toluidine blue. Following initial screening of toluidine blue stained sections, ultrathin (800–900Å) sections are cut with a diamond knife, mounted on copper grids, and stained with 2% uranyl acetate and Reynolds' lead citrate.

Some TEM assessment is done by the OREHP pathologist, but the majority of scope work, and all of the processing and sectioning, is done by the California Animal Health and Food Safety (CAHFS) laboratory in Davis, California. Mounted ultrathin sections are viewed with either a Zeiss or Phillips transmission electron microscope. Cells from target organs are examined for subcellular lesions and the presence of viral particles in the nucleus or cytoplasm. For nonviral pathogens, lesions are scanned to locate, identify, and characterize rickettsial or protozoan parasites.

Samples for direct EM examination are used to identify gastrointestinal (GI) parasites that are shed into the lumen of the GI tract. Direct EM is specifically used by OREHP to try and identify a suspect herpes viral pathogen. Direct EM samples are taken from pyloric caecae and intestine; the stomach is avoided to prevent sample degradation from gastric acids. The gall bladder (closely associated with the intestine in WSB) is similarly avoided to prevent damage from bile salts. Contents of pyloric caecae or intestine are emptied into plastic cryovials using forceps, and are frozen and stored at  $-70^{\circ}$  to  $-80^{\circ}\text{C}$ . Direct EM samples are shipped on dry ice to the CAHFS laboratory. Samples are rinsed and filtered prior to EM examination for viral particles.

**Microbiology.** Microbiology includes the fields of mycology, bacteriology, and virology. All are geared towards isolation and growth of microorganisms on artificial media or in cell culture. Fungal infections in cultured WSB are rare. Diagnosis is usually made via cytology, but occasionally, fungal colonies will be isolated on Sabouraud-dextrose agar. Major bacterial pathogens of WSB are *Vibrio* spp. and *Flexibacter maritimus*. Although infections are also routinely diagnosed using wet mount cytology, culture on artificial media is necessary for bacterial identification and to determine antibiotic sensitivity. Skin is the primary target organ for both *Vibrio* (usually as a secondary invader) and *Flexibacter* (usually as a primary pathogen). *Vibrio* also occurs as a disseminated infection, attacking kidney and brain.

Samples are ideally taken from freshly euthanized fish, but can be taken from euthanized or dead fish that have been stored at  $4^{\circ}\text{C}$  (or on ice) for up to 12 hours. Sterile technique, employing flame sterilized metal loops or prepackaged sterile plastic loops, is used to take initial samples. *Flexibacter* is cultured on specialized cytophaga agar, while *Vibrio* species are cultured on blood agar. Colonies take 1–3 days to appear. The hatchery manager, Paul Curtis, routinely processes fungal and bacterial samples at the Carlsbad Hatchery. Some *Vibrio* samples have been sent to the University of California at Davis (UC Davis) for speciation.

The major rickettsial pathogen of concern for WSB is *P. salmonis*. The primary target organ for *P. salmonis* is the liver and lesions appear as multifocal, pale tan to yellow granulomas. *P. salmonis* requires culture on a chinook salmon (*Oncorhynchus tshawytscha*) embryo cell line (CHSE-214) and all liver samples from suspect fish are shipped on ice overnight to UC Davis.

There are three viral pathogens of concern for cultured WSB: viral nervous necrosis virus (VNNV), viral hemorrhagic septicemia virus (VHSV) and a suspect herpes virus that has only been identified using TEM. Samples for virus isolation (VI) assays include: eye and brain (for VNNV), spleen and kidney (for VHSV) and pyloric caecae and intestine (for herpes virus). The liver has also occasionally been sampled for VI. With liver, the left lobe is collected (the right lobe and associated gall bladder are not sampled). Splenic samples are taken by freeing the organ from the gastrosplenic ligament (mesentery), being careful not to incise the gall bladder. Trunk and tail kidney are sampled by sharp dissection, using either a scalpel or razor blade to free the organ from the attached spine. Eyes are dissected by grasping conjunctival tissues with forceps, applying traction and using scissors to cut periocular connective tissue, extraocular muscles, and the optic nerve. The dissection and removal of the brain, pyloric caecae, and intestine are covered above.

VI samples are stored in chilled ( $4^{\circ}\text{C}$ ) minimal essential media and shipped overnight to UC Davis on ice. VNNV is cultured on a snakehead fish cell line (SNN-1), while VHSV is cultured on a carp cell line (EPC). Both VNNV and VHSV have characteristic cytopathic effect when grown on the appropriate cells lines. Positive cultures are confirmed with either PCR or TEM. Attempts have been made to culture the herpes virus using several fish cell lines, but have to date been unsuccessful.

**Enzyme-linked immunosorbent assay.** ELISAs have been developed by Dr. Ronald Hedrick's laboratory at UC Davis to assess pathogen exposure in WSB to three major pathogens: VNNV, VHSV, and *P. salmonis*. ELISAs work by detecting antibodies specific for the three pathogens in circulating blood. Although ELISAs detect exposure and not infection, the main advantage is that a fish could have been exposed months or possibly years prior to sampling and still have detectable antibody levels in peripheral blood.

For WSB <15 cm TL, a 1 ml syringe with a 2.5 cm, 26 gauge needle is used to draw blood. The needle is inserted on the ventral midline, adjacent to the anal fin, to access the large vertebral vein located ventral to the spinal column. Approximately 0.3–1.0 ml of blood can be obtained from a single fish. Blood from 2–6 small fish is often pooled for a single serum sample. For larger juvenile WSB, a 2.5 or 3.75 cm 18 gauge Becton Dickinson Vacutainer needle (and associated Vacutainer sleeve) is used to draw blood. One to 10 ml of blood can be collected from a larger juvenile or subadult fish. Blood samples are collected in Vacutainer SST serum separation tubes. Blood is allowed to clot at room temperature for 20–30 minutes and then stored at 4°C for up to 48 hours. Clotted blood is centrifuged for 6–10 minutes at 1,000–1,300 RCF (g) in a swing bucket centrifuge. Serum is pipetted off and stored as 0.5–1.0 ml aliquots in 2 ml plastic cryovials. Serum is frozen and stored at –70° to –80°C. Frozen serum samples are shipped on dry ice to UC Davis for final ELISA assessment.

ELISAs are layered assays conducted in multiwell plastic plates. The initial antigen layer is derived from viral or rickettsial pathogens grown in cell culture. The second layer is serum from wild or cultured WSB that has varying concentrations of antibodies specific to the pathogen antigens. The third layer is a biotinylated-rabbit anti-WSB polyclonal antibody. The rabbit antibodies bind specifically to the WSB immunoglobulin. The fourth layer is a horseradish peroxidase (HRP) streptavidin, which binds selectively to biotin on the rabbit antibodies. The final layer is tetramethylbenzidine, a substrate specific for the HRP enzyme. Positive samples change color from yellow to blue. Degree of optical density (OD) is determined by an automated plate reader. Degree of OD is dependent on the amount of pathogen-specific WSB antibody present in the serum sample; the greater the OD, the higher the antibody titer. Positive samples are those with OD higher than that of positive-control samples. Positive-control serum is obtained from either

controlled laboratory exposures or from confirmed disease outbreaks among hatchery fish.

**Polymerase chain reaction.** PCR assays have been developed by Dr. Ronald Hedrick's laboratory at UC Davis to detect VNNV, VHSV, and *P. salmonis* infection in WSB. PCR is a sensitive, highly accurate molecular assay designed to detect pathogen genetic material (RNA or DNA) via use of specific primers followed by exponential gene amplification. The primary drawbacks are: 1) the assays cannot determine level of infection, 2) the assays cannot determine degree of host damage, and 3) a relatively slow turnaround time.

### **Diseases and Pathogens of Cultured White Seabass**

Diseases of cultured WSB can be divided into noninfectious, infectious, and parasitic. Noninfectious diseases are not covered here. Infectious diseases include viral, bacterial, rickettsial, and fungal diseases. There are three major viral diseases of concern for cultured WSB: VNN, VHSV, and herpes virus gastroenteritis (HVGE). VNN is a lethal, highly contagious disease of larval WSB; HVGE is a lethal, highly contagious disease of juvenile WSB. VHSV has not been confirmed in WSB, but is of concern because it has been isolated from several baitfish species caught in Southern California waters (Hedrick et al. 2003). Bacterial diseases include cutaneous infections by *F. maritimus* and various *Vibrio* species. In addition, at least one *Vibrio* species (tentatively identified as *V. alginolyticus*) is the causative agent of a lethal disseminated infection involving kidney and brain. Two rickettsial diseases afflict WSB: one is a transient, benign infection of the gills by an *Epitheliocystis* sp.; the other, piscirickettsiosis, is a lethal systemic infection caused by *P. salmonis*. Fungal infections, as stated above, are rare.

Parasitic diseases of cultured WSB include metazoan, protozoan, and crustacean parasites. No cestodes have been recovered from cultured WSB, but three trematode species have been found in gills of netpen fish: *Anchoromicrocotyle guaymensis* (previously identified as *Cynoscionicola psuedoheterocantha*), *Gyrodactylus* sp., and an unidentified fluke species. Protozoan parasites include: three ciliates (*Uronema marinum*, *Trichodina* sp., and at least one unidentified ciliate), four flagellates (*Ichthyobodo* sp., *Cryptobia* sp., *Hexamita* sp., and one unidentified flagellated protozoan), and one sporozoan (a probable

myxosporidian parasite commonly found in mesonephric ducts of WSB in growout pens). Parasitic isopods have occasionally been observed attached to fins of WSB at one netpen site in Huntington Beach.

The three most important diseases of cultured WSB are VNN, HVGE, and piscirickettsiosis. All three are lethal, highly contagious, and, for the most part, untreatable. As such, these three diseases pose the greatest challenge to OREHP, both from a hatchery production standpoint and from a disease risk standpoint to wild fish stocks.

**Viral nervous necrosis.** VNN is a lethal nodaviral disease of larval WSB (Curtis et al. 2001). Prior to the spring of 2003, VNN epizootics were a regular occurrence at the Carlsbad Hatchery. Since installation of an ozone water treatment system at the hatchery in 2003, there have been no outbreaks. The etiologic agent is a single-stranded RNA virus. VNV primarily infects larval WSB 20–40 days posthatch; target organs are retina of the eye, brain, and spinal cord. Clinically, affected larval fish present as paralyzed fish, floating on their sides at the surface of the water. Histologically, target organs have characteristic necrotizing and cystic lesions. Presumptive diagnosis is made via observation of larval fish with classic clinical signs. Confirmation of VNN is made with histology, TEM, culture on SNN-1 cells, and PCR. There is no treatment.

**Herpes virus gastroenteritis.** HVGE is a lethal, highly contagious viral disease of juvenile WSB. It primarily affects smaller (<15 cm TL), younger (<4 months) hatchery seabass exposed to ambient lagoon waters during fall and winter months. There have been two confirmed outbreaks and both occurred at the Carlsbad Hatchery: one in the fall of 2002, the second in the fall of 2005. Mortality can exceed 3,000/day if HVGE occurs simultaneous with *Flexibacter*. Typical clinical signs (when uncomplicated with *Flexibacter*) are: 1) high mortality among fish with no cutaneous lesions, 2) yellow-white stringy fecal casts in the water, and 3) terminal spiraling prior to death. Target organs are stomach, pyloric caecae, and intestine. Gross lesions include moderate to massive dilation of the entire GI tract, excessive amounts of clear fluid in the GI tract, occasional gastric intussusception, variable ascites, and dilated urinary bladders. Histologically, there is multifocal necrosis of mucosal epithelium of pyloric caecae and intestine, with minimal inflammation. Some epithelial cells may have marginated chromatin

and an absence of nucleoli. The diagnosis is confirmed with TEM. There is no PCR assay available and the virus has not been successfully grown in cell culture. There is no treatment.

**Piscirickettsiosis.** Piscirickettsiosis is the third major disease of concern for OREHP (Arkush et al. 2005, Chen et al. 2000). The causative agent is a *Piscirickettsia salmonis*. *P. salmonis* epizootics have occurred twice since the hatchery opened. The first outbreak occurred in 1998 and involved multiple hatchery systems as well as several netpen sites. The second outbreak occurred in April 2005 and involved a single netpen site at King Harbor in Redondo Beach. Clinically, *P. salmonis* infected WSB are slow moving, moribund fish with scattered, small, white foci of depigmentation over the flanks. Characteristic gross lesions include: linear streaking in gill filaments, a fibrinous necrotic exudate over the heart, and multifocal, pale tan to yellow, nodular masses in the liver. The diagnosis can be confirmed with histology, culture on CHSE-214 cells, PCR, or TEM. Although treatment with tetracycline antibiotics is theoretically possible, treatment has thus far not been attempted.

### Management of Virulent Disease

The mortality rate among even the most virulent infectious disease in cultured WSB is never 100%, so the question becomes: what should OREHP do with the thousands of fish that have survived exposure to VNNV, HVGE, and *P. salmonis*? Disease epizootics that occur at netpen sites can involve up to 10,000 cultured WSB; outbreaks in the hatchery's raceway system can impact up to 60,000 older (3–6 month) juvenile fish. Survivors are often fish into which OREHP has invested a significant amount of time, effort, and money, and which represent a high percentage of total release numbers. If this were an aquaculture operation, the answer would be simple: as long as there was no danger of pathogen transfer to humans, surviving stocks would either be sold or eaten. But since this is an enhancement program, OREHP has to consider the relative risk of disease transfer to the wild fish stocks they are seeking to help.

### Disease Surveillance of Wild WSB

To assess the risk to wild seabass from lethal, highly contagious diseases occurring in cultured WSB, OREHP initiated a comprehensive disease surveillance program in 2002. The goal is to survey wild marine fish populations in order to determine

which lethal infectious diseases are naturally occurring or endemic to wild stocks. The rationale is that if a disease is endemic among wild fish, then the relative risk from exposed or infected hatchery fish is relatively small.

Although WSB were the primary focus of wild fish surveys, other native California marine fish species in which OREHP is interested were also sampled. Some of these other species include: California sheephead (*Semicossyphus pulcher*), California halibut (*Paralichthys californicus*), California yellowtail (*Seriola lalandi*), lingcod (*Ophiodon elongatus*), vermillion rockfish (*Sebastes miniatus*), bocaccio rockfish (*S. paucispinis*), and cowcod rockfish (*S. levis*). OREHP's plan of action was simple: 1) sample a large number of wild fish, 2) assess pathogen exposure and infection rates, and 3) use the data to make informed decisions regarding release of infected or exposed hatchery fish.

Total catch numbers after 3.5 years of sampling were: 272 wild WSB, 124 bocaccio rockfish, 43 vermillion rockfish, 6 cowcod rockfish, 146 California halibut, 83 sheephead, and 17 assorted other fish species. Sample numbers for just wild WSB were: 195 ELISA serum samples, 100+ brain samples for VNNV VI and PCR, 100+ eye samples for VNNV VI and PCR, 80+ spleens for VHSV VI and PCR, 80+ kidneys for VHSV VI and PCR, 80+ liver samples for *P. salmonis* isolation and PCR and 100+ intestinal content samples for direct EM assessment of herpes virus. All wild fish samples were sent to UC Davis and sample analyses are ongoing.

Preliminary ELISA results indicate that VNNV exposure is widespread among wild WSB. Among wild juvenile or subadult WSB (i.e., those <72 cm TL), 18% (14/78) of serum samples were ELISA-positive for VNNV exposure. Among wild adult WSB, 53% (9/17) of serum samples were VNNV-positive with ELISA. In contrast, none of the 94 serum samples analyzed thus far via ELISA have been positive for *P. salmonis* exposure. ELISA results for VHSV are pending, and currently there is no ELISA assay specific for the herpes virus that occurs in WSB.

All attempts to isolate virus or rickettsia from wild WSB have failed. A small number of PCR samples have been assessed and these have also turned up negative for virulent pathogens known to occur in cultured WSB. Results from the majority of PCR samples, however, are still pending. Of the more than 100 intestinal content samples taken, 50 have been analyzed via direct EM for herpes virus. A single direct EM sample had suspect hexagonal

profiles, but did not contain nucleocapsid material and was classified as negative for herpes virus.

## Wild Fish Disease Survey Conclusions

Preliminary results from OREHP's wild fish survey lead to three conclusions. First, VNNV is probably a naturally occurring disease among wild WSB. Second, it is likely that *P. salmonis* is an exotic disease. Third, the disease status of wild WSB for VHSV and herpes virus is still unknown.

## Impact on OREHP Policies and Hatchery Operations

The impact wild fish disease survey data have on hatchery operations is that OREHP can now make informed decisions regarding what to do when virulent disease outbreaks occur. With VNNV epizootics, the hatchery can reasonably decide to salvage survivors and release them at a later date when they are healthy. In contrast, with *P. salmonis*, the assumption has to be that this disease does not occur among wild WSB, and that any cultured seabass infected or exposed to this pathogen should be euthanized. With herpes and VHSV, there still is not enough information to determine whether or not these two diseases are endemic to wild fish stocks. We believe that herpes virus is probably a naturally occurring disease among wild WSB, but until there is definitive proof, OREHP policy will be to operate as if it too were an exotic disease.

## References

- Arkush, K. D., A. M. McBride, H. L. Mendonca, M. S. Okihira, K. B. Andree, S. Marshall, V. Henriquez, and R. P. Hedrick. 2000. Genetic characterization and experimental pathogenesis of *Piscirickettsia salmonis* isolated from white seabass *Atractoscion nobilis*. *Dis. Aquat. Organ.* 63:139–149.
- Chen, M. F., S. Yun, G. D. Marty, T. S. McDowell, M. L. House, J. A. Appersen, T. A. Guenther, K. D. Arkush, and R. P. Hedrick. 2000. *Piscirickettsia salmonis*-like bacterium associated with mortality of white seabass *Atractoscion nobilis*. *Dis. Aquat. Organ.* 43:117–126.
- Curtis, P. A., M. Drawbridge, T. Iwamoto, T. Nakai, R. P. Hedrick, and A. P. Gendron. 2001. Nodavirus infection of juvenile white seabass, *Atractoscion nobilis*, cultured in southern California: First record of viral nervous necrosis (VNN) in North America. *J. Fish Dis.* 24:263–271.
- Eschmeyer, W. N., and E. S. Herald. 1983. Croakers: Family *Sciaenidae*. In R. T. Peterson (ed.). *A field guide to Pacific Coast fishes of North America*, p. 218–222. Houghton Mifflin Company, Boston, Massachusetts.



Hedrick, R. P., W. N. Batts, S. Yun, G. S. Traxler, J. Kaufman, and J. R. Winton. 2003. Host and geographic range extensions of the North American strain of viral hemorrhagic septicemia virus. *Dis. Aquat. Organ.* 55:221–220.

# Juvenile Mass Production of the Black Rockfish (*Sebastes schlegeli*) in FRA Miyako Station: Present Status and Problems

Masahiro Nakagawa  
Miyako Station  
National Center for Stock Enhancement  
Fisheries Research Agency  
4-9-1, Sakiyama, Miyako  
Iwate 027-0097, Japan  
mnakagaw@affrc.go.jp

Junichi Adachi  
Shibushi Station  
National Center for Stock Enhancement  
Fisheries Research Agency

Ken Shimizu  
Fisheries Stock Enhancement Department  
Fisheries Research Agency

Satoshi Shiozawa  
Amami Station  
National Center for Stock Enhancement  
Fisheries Research Agency

**Keywords:** *Sebastes schlegeli*, black rockfish, mass production, stock enhancement

## Abstract

We reviewed the results of black rockfish (*Sebastes schlegeli*) mass production at FRA Miyako Station, Japan, between 1982 and 2004. Miyako Station began testing juvenile production of the species in 1980. Initially, live food was mainly used for the tests, but cultivation and securing that food required a large amount of labor. Two types of food, *Artemia* nauplii and formulated feed, were used for juvenile production beginning in 1999; thus, a juvenile production system that was free from the difficulties involved with the cultivation of most live foods was established. A juvenile black rockfish with a total length of 30 mm currently costs 8.5 yen. The survival rate of juveniles now averages approximately 50%, but it used to fluctuate widely from 19.6% to 81.4%. Early mortality of juveniles; in particular those up to 10 days after birth, was higher and more variable. Even now, early mortality is an obstacle to juvenile production. To stabilize the technique for juvenile production of this species, it is essential to develop a method to curb early mortality.

## Introduction

Juveniles of six rockfish species (*Sebastes schlegeli*, *S. inermis*, *S.s pachycephalus*, *S.s vulpes*, *S. thompsoni* and *S. oblongus*) are currently produced in Japan. Of those species, the black rockfish, grows fastest (Nagasawa 2001) and moves in a limited range after being released (Nakagawa et al. 2004). For those reasons, in 2002, 3.5 million juvenile black rockfish—70% of all rockfish produced that year were reared for stock enhancement and mariculture

(Fisheries Agency & Fisheries Research Agency 2004). The species is also important to mariculture in Korea, as is the Japanese flounder (*Paralichthys olivaceus*) (Lim et al. 2004).

A study of the production of juvenile black rockfish was undertaken by the fisheries experimental station of Aomori Prefecture in the 1970s. That was followed by production of juveniles of the species in Hokkaido, Akita, Yamagata, Miyagi, Hiroshima, Fukushima, Niigata and Ehime

Prefectures (Kusakari 1995). The Japan Sea-Farming Association (JASFA, predecessor of the Miyako Station of the National Center for Stock Enhancement, Fisheries Research Agency) began testing mass production of juveniles in 1980. The technique for juvenile production is now considered to be almost established, but the scale of rearing tanks varies among research agencies. Development of the juvenile production technique at Miyako Station in recent years has therefore been aimed at reducing the unit cost of juvenile production. On the other hand, the survival rate of juveniles with total lengths up to 30 mm has now reached approximately 50%, but it has varied greatly from 19.6% to 81.4% (Shiozawa 1985, 1986, 1988; Shimizu 1989, 1990, 1991, 1992; Adachi 1993, 1994, 1995, 1996, 1997; Nakagawa 1998, 1999a, 2000, 2001, 2002, 2003). This cannot be described as a stable survival rate. This report reviews results of the examination of juvenile production at Miyako Station. Subsequently, we describe the tasks that remain to be accomplished.

### Changes in Feed Composition

Table 1 shows changes in the types of feed given to larvae and early juvenile black rockfish.

**Table 1. Changes in feed composition on mass production of black rockfish, *Sebastes schlegeli*.**

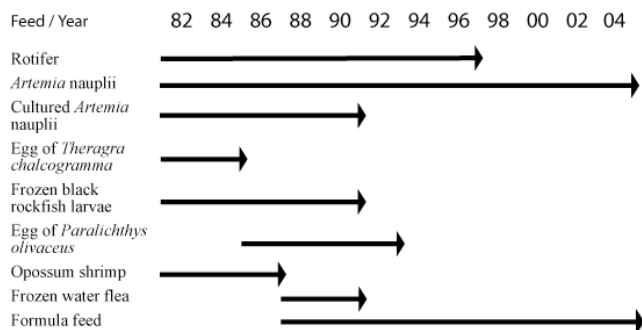

**First period (1982–1993).** Juveniles were produced by giving live foods such as rotifers (*Brachionus plicatilis*), *Artemia* nauplii, cultured *Artemia*, eggs of pollock (*Theragra chalcogramma*) and Japanese flounder, frozen larvae of black rockfish, frozen water fleas and frozen mysids.

Dependence on live food was high and a large amount of labor was required to cultivate and secure feed during the period. The spread of disease and deterioration of rearing water were feared because fish eggs were used as food.

**Second period (1994–1998).** An automatic feeding machine was developed that was capable of dispensing a formula feed consisting of minute particles (400 μm), making it possible to employ it early in life the fish. Rearing during the period began by providing a combination of three types of feed: rotifers, *Artemia* nauplii and formula feed. The production system, which had been centered on live feed, was changed to one based on formula feed, thereby saving labor.

**Third period (1999–present).** It was thought possible to start using *Artemia* nauplii as an early live food because the average total length of newborn larvae of the black rockfish is 7 mm. Rotifers and *Artemia* nauplii had been used previously in combination as live food for juvenile production, but it was suggested that juvenile production was possible by feeding *Artemia* nauplii alone (Nakagawa 2000). To test the hypothesis black rockfish larvae were fed either a combination of live rotifers and *Artemia* nauplii (Group I) or *Artemia* nauplii alone (Group II). Larvae were reared for 15 days in 500 L tanks. The average total length ±SD after 15 days of rearing was 12.4 mm ±1.1 mm in Group I larvae and 12.6 mm ±0.7 mm in Group II. No significant difference ( $p > 0.05$ ) was found between the two groups. The average survival rates were 65.1% in Group I and 64.9% in Group II. Therefore, two types of feed, *Artemia* nauplii and formula feed, were used for mass production of black rockfish beginning in 1999. A juvenile production system that does not require rotifer cultivation was thus established.

### Current Rearing Conditions Used for Mass Production

For juvenile production, it is most important to ensure that few individual larvae are deformed or swim with marked instability. The larvae were quantified, and healthy larvae were transferred using a 50 mm diameter siphon hose to 50,000 L square concrete tanks (8×4.8×1.6 m) at a density of 10 larvae/1 L. For production of juvenile black rockfish, we used a titanium and steel heater that used heat from a boiler, a ventilation device with a blower, an automatic bottom vacuum cleaner and an automatic feeder for formula feed. *Artemia* nauplii at 5–300 million per tank were provided in two or three feedings each day. Incubation of *Artemia* eggs was controlled at a tank temperature of 22°C and eggshells and *Artemia* nauplii were separated 42 h after hatching. *Artemia* nauplii were enriched for 24 h at 20°C by addition of nutrients (Plus-Aqualan,

BASF Japan Ltd.) at a density of 50 g/1,000 L. One liter of freshwater chlorella concentrate (*Chlorella* sp., Fresh Green 600, Nisshin Science Co., Ltd.) was added to the rearing water in two or three portions a day for up to 30 days after birth (DAB). Formula feed was given from about 10 DAB in amounts of 50–5,000 g per tank in 8–16 portions daily. The water temperature was increased by 1°C/day from 13°C at the beginning of rearing period to the optimum rearing temperature of 18°C, after which it was maintained at that temperature. The daily water exchange rate was set at 50–100% of the total from 0–10 DAB, 100–300% from 10–20 DAB, 300–800% from 20–30 DAB, and 800–1,200% after 30 DAB.

Sand-filtered seawater was used for rearing larvae and early juveniles, and for incubation and nutrient enrichment of *Artemia* nauplii. The tank floors were cleaned using an automatic bottom vacuum cleaner every day and dead larvae were counted at that time. The total length of the larvae or juveniles was measured every five DAB, and specimens (fixed in 10% formalin) were collected to determine their developmental stages.

### Survival Rate and Unit Number of Juveniles Produced

Table 2 presents the results of juvenile production examinations that were conducted using 50,000 L tanks. The number of juveniles produced represents the sum of the number of juveniles for each 1,000 L of rearing tank (hereafter called the unit production number) because the number of tanks used varied among years. As indicated in the classification above, 1982–1993 was defined as the first period, 1994–1998 constituted the second period, and 1999 and after was the third period. The unit production numbers of juveniles, rearing times, and the total lengths of juveniles at the end of production covering each of three periods were compared using Scheffé's F certification method. Results showed no significant differences among the periods in the unit production numbers of juveniles ( $p > 0.05$ ), but the total lengths of juveniles at the end of production and the rearing times differed significantly between the first and third periods ( $p < 0.05$ ). An increase in mortality rates as a result of handling at harvest was observed when the total length of juveniles averaged 25 mm at the end of production. The significantly prolonged rearing times were attributable to the increased size of the harvest, which was intended to raise the survival rate after harvesting. Survival rates were converted into variables and compared using Scheffé's F

certification method, but no significant differences were found among periods ( $p > 0.05$ ). Therefore, it was concluded that changes in feed composition did not cause a decline in survival rate. Labor savings in juvenile production and improvement in production efficiency became possible through a reduction in the variety and type of feed required for juvenile production.

**Table 2. Results of mass production breeding experiments in the black rockfish, *Sebastes schlegelii*.**

Year	Period	No. of tanks (50L)	INITIAL		FINAL		Survival rate (percent)	Total length (mm)	Avg. rearing period (days)
			No. of fish (ind)	No. of fish (ind./L)	No. of fish (ind)	No. of fish (ind./L)			
1982	I	3	498,000	3,320	306,000	2,040	61.4	20.3	32.7
1983		3	543,000	3,620	294,000	1,960	54.1	N.D.	N.D.
1984		4	782,000	3,910	383,000	1,915	49.0	28.2	38.0
1985		3	1,054,000	7,027	453,000	3,020	43.0	28.4	42.8
1986		4	1,424,000	7,120	633,000	3,165	44.5	30.2	42.8
1987		3	1,165,000	7,767	499,000	3,327	42.8	32.1	44.3
1988		2	1,346,000	13,460	652,000	6,520	48.4	30.6	38.0
1989		4	2,631,000	13,155	774,000	3,870	29.4	25.3	33.5
1990		3	1,870,000	12,467	1,207,000	8,047	64.5	24.5	37.3
1991		3	1,659,000	11,060	667,000	4,447	40.2	26.6	39.0
1992		3	1,348,000	8,987	967,000	6,447	71.7	25.1	40.0
1993		3	3,642,000	24,280	1,305,000	8,700	35.8	24.3	41.0
	Ave. <sup>1</sup>		9,681		4,455	48.8	26.9	39.0	
1994	II	3	1,569,000	10,460	899,000	5,993	57.3	26.2	39.0
1995		3	651,000	4,340	559,000	3,727	85.9	30.8	37.3
1996		3	1,680,000	11,200	1,257,000	8,380	74.8	28.4	40.7
1997		2	890,000	8,900	219,000	2,190	24.6	31.2	44.0
1998		3	1,302,000	8,680	777,000	5,180	59.7	29.4	43.7
	Ave. <sup>1</sup>		8,716		5,094	60.5	29.2	40.9	
1999	III	2	1,080,000	10,800	444,000	4,440	41.1	31.8	46.5
2000		3	1,718,000	11,453	518,000	3,453	30.2	31.0	49.0
2001		3	1,500,000	10,000	749,000	4,993	49.9	33.8	43.3
2002		3	1,550,000	10,333	766,000	5,107	49.4	35.8	46.7
2003		2	1,034,000	10,340	828,000	8,280	80.1	28.8	40.5
2004	2	1,193,000	11,930	631,000	6,310	52.9	34.0	43.0	
	Ave. <sup>1</sup>		10,809		5,431	50.6	32.5	44.8	
	Ave. <sup>2</sup>		9,766		4,848	51.8	28.9	41.0	

N.D.: No data  
Ave.<sup>1</sup>: Average of every period  
Ave.<sup>2</sup>: Average of all periods

### Growth and Development

Figure 1 shows the growth of larvae and juveniles reared in 50,000 L tanks. The equation  $Y = 5.6609e^{0.184x}$  ( $r^2 = 0.9967$ ) represents the relationship between the total length and DAB. Variations became greater as rearing progressed.

Table 3 shows results of observations of the developmental stages of larvae and juveniles reared in 50,000 L tanks. Larval development was classified into seven stages according to the method of Nagasawa (2001): A preflexion larva, B flexion larva I, C flexion larva II, D postflexion larva, E transforming larva, F pelagic juvenile I and G pelagic juvenile II.

Larvae that reached stage B immediately after birth were observed in 2001 and 2003. Tanks in which the larvae were born had only small capacities (1,000 L). Therefore, the possibility of larvae born the previous day or earlier remaining in the tank was considered extremely low. Therefore, it was assumed that the larvae that reached stage B immediately after birth had overgrown in the mother's body. This seems to have resulted from a time gap between the growth of the larvae and their delivery, but its

mechanism and causes remain unknown. It took about 5 days for larvae to move between stages from A to D, but 10 days were required from stage D to E and more than 15 days from stage E to F. The later the stage, the more days were required to develop to the next stage. In all years except 1999, the larvae reached developmental stage G 40 DAB.

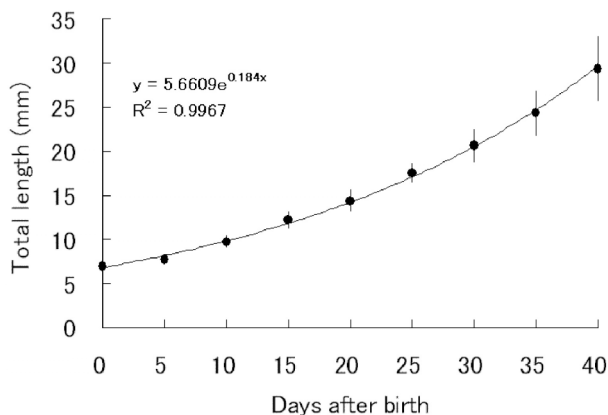

**Figure 1.** Growth of larvae and early juveniles in black rockfish, *Sebastes schlegeli*. Closed circles and vertical lines indicate mean total length and one unit of standard deviation of total length.

**Table 3.** Developmental-stage composition (%) in larval and early juvenile *Sebastes schlegeli*.

Year	Stage	DAB <sup>††</sup>								
		0	5	10	15	20	25	30	35	40
1998	A	100.0	3.3							
	B		96.7							
	C			100.0						
	D				13.3	3.3				
	E				86.7	96.7	100.0	10.0		
	F							80.0	26.7	6.7
	G							10.0	73.3	93.3
1999	A	100.0								
	B		100.0	20.0						
	C			80.0	16.7					
	D				83.3	30.0				
	E					70.0	70.0	66.7	10.0	6.7
	F						30.0	33.3	80.0	33.3
	G								10.0	60.0
2000	A	100.0								
	B		100.0							
	C			63.3						
	D			36.7	13.3					
	E				86.7	100.0	26.7			
	F						73.3	36.7	6.7	
	G							63.3	93.3	100.0
2001	A	6.7		6.7						
	B	93.3	96.7	13.3						
	C		3.3	80.0						
	D				40.0	6.7				
	E				60.0	93.3	30.0	6.7		
	F						70.0	86.6	26.7	6.7
	G							6.7	73.3	93.3
2002	A	100.0								
	B		16.7							
	C		83.3	13.3						
	D			86.7						
	E				100.0	100.0	73.3	10.0	3.3	
	F						26.7	90.0	36.7	6.7
	G								60.0	93.3
2003	A	60.0								
	B	40.0	33.3							
	C		66.7	40.0						
	D			60.0						
	E				3.3					
	F				96.7	100.0	80.0	10.0		
	G						20.0	90.0	6.7	93.3

<sup>††</sup> DAB: days after birth

## Mortality Patterns

The survival rate of black rockfish at Miyako Station reached nearly 50%, but it remained unstable, fluctuating widely from 19.6% to 81.4% (Table 1). Daily changes in the mortality rate during the rearing time (Figure 2) and in the shapes of individuals were observed during juvenile production from 1998–2003 to accurately determine mortality patterns in early juveniles. Although minor differences were visible, depending on the rearing lot, increases in the mortality rate were observed in larvae and juveniles from 0–10 DAB, 18–22 DAB and 30–35 DAB, a pattern that was common to all years. It is noteworthy that a mortality rate amounting to 10% of the total in one day was observed in early juveniles from 3–4 DAB in 2000. Normal larvae at that time had reached developmental stages B–C, and the average total length was 7.7 mm ± 0.3 mm. However, dead fish were numerous in developmental stages A–B and their average total length was 6.8 mm ± 0.2 mm, or smaller than at birth. Those dead fish were presumed to have died of starvation because they had deformed mouths and vertebrae. Furthermore, every fish in that population had an empty stomach. Between 18 and 22 DAB, both surviving and dead fish reached developmental stage D or E, with no significant difference in average total length. Numerous food organisms were found in the digestive tracts of fish that died at 18–22 DAB, which differed greatly from the scenario in dead fish found 0–10 DAB. One fish was seen swimming belly-up on the surface of the rearing water the day before the increase in mortality rate. When dissected, that individual was found to have an air bladder that was far more inflated than those of normal fish, implying death from gas-balance disorder. Aerating the seawater immediately before it is poured into the rearing tanks minimizes mortality. Mortalities of larvae from 30 to 35 DAB occurred from cannibalism that was attributed to differences in growth rates.

## Unit Cost of Juveniles

Based on rearing data for 2003, we calculated the unit cost of juvenile black rockfish reared to a total length of 30 mm. Computed expenses included wages; electricity and heating bills; costs of feed, materials, and consumables; as well as rental costs, but they did not include depreciation costs of the facilities. Unit costs of juveniles were calculated by dividing the costs of the two production processes of broodstock rearing and juvenile production by the number of fish produced. That result was 8.5 yen. Itemization revealed that wages accounted for 39.6%

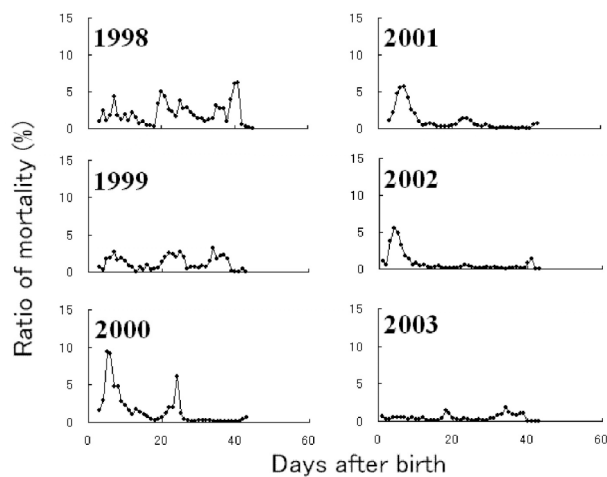

**Figure 2.** Changes in the mortality of black rockfish *Sebastes schlegeli* larvae and early juveniles during 1998–2003. Closed circles indicate mortality.

of the total, followed by electricity and heating bills at 25.3% and the cost of feed at 15.8%. Those three items added up to more than 80% of the total expenses. Unit costs of juveniles by size were calculated tentatively, including expenses for intermediate rearing as indicated by Nakagawa and Okouchi (2003a). Results were: 8.5 yen for 30 mm fish, 10.4 yen for 40 mm, 13.5 yen for 60 mm, 15.9 yen for 80 mm, and 18.3 yen for 100 mm.

### Future Tasks

For efficient juvenile production, it is necessary to develop a technique to secure quality newborn larvae intensively and in massive quantities. Each day, more than 1 million newborn larvae of multiple-spawning fish such as Japanese flounder are now obtainable on a stable basis, thanks to advances in the techniques used for broodstock rearing (Thuzaki 1994). However, the black rockfish, which is viviparous, spawns only once a year (Kusakari 1995). In addition, the larvae produced per broodstock are as few as 200,000 (Nakagawa and Okouchi in press). The fish do not synchronize their spawning in groups (Nakagawa and Hirose 2004). Therefore, it has been difficult for most juvenile production agencies to obtain larvae of the species in large quantities at one time. Using a cannulation method, Yamada and Kusakari (1991) developed a technique to estimate the birth dates of larvae from examination of embryonic developmental stage. Using the same technique, Nakagawa and Okouchi (in press) have implemented a method of selecting female broodstock estimated to be near spawning and thereby obtaining larvae intensively. Broodstock of

this species mate in November of each year (Mori et al. 2003), but they discharge unfertilized eggs if they do not mate at around the time of spawning. The new technique has also made it possible to use the cannulation method to select broodstock that discharge unfertilized eggs. Consequently, the technique for obtaining larvae intensively is nearly complete.

As noted here, however, many individuals among larvae obtained in large quantities are apparently deformed or swim unsteadily, accounting for a major fraction of early mortalities. This phenomenon occurs immediately after spawning. For that reason, it might be attributable to some cause that is inherent in the broodstock. Stabilizing the technique for the production of juveniles of this species demands reexamination of the way broodstock are managed. Development of techniques for minimizing early mortality rates is also necessary, as are techniques for identifying abnormal larvae in the embryo stage, before delivery.

### References

- Adachi, J. 1993. Juvenile production of black rockfish. Annual report of the Japan Sea-Farming Association in 1991, Tokyo, p.159–162 [in Japanese].
- Adachi, J. 1994. Juvenile production of black rockfish. Annual report of the Japan Sea-Farming Association in 1992, Tokyo, p.143–145 [in Japanese].
- Adachi, J. 1995. Juvenile production of black rockfish. Annual report of the Japan Sea-Farming Association in 1993, Tokyo, p.153–155 [in Japanese].
- Adachi, J. 1996. Juvenile production of black rockfish. Annual report of the Japan Sea-Farming Association in 1994, Tokyo, p.141–143 [in Japanese].
- Adachi, J. 1997. Juvenile production of black rockfish. Annual report of the Japan Sea-Farming Association in 1995, Tokyo, p.165–167 [in Japanese].
- Fisheries Agency & Fisheries Research Agency. 2004. Materials on the production and release of fingerlings for sea-farming in 2002, Tokyo, p. 431 [in Japanese].
- Kusakari, M. 1995. Studies on the reproductive biology and artificial juvenile production of kurosoi, *Sebastes schlegeli*. Bull. Hokkaido Pref. Fish. Exp. Stn. 47:41–124 [in Japanese with English abstract].

- Lim, S. R., S. M. Choi, X. J. Wang, K. W. Kim, I. S. Shin, T. S. Min and S. C. Bai. 2004. Effects of dehulled soybean meal as a fish meal replacer in diets for fingerling and growing Korean rockfish *Sebastes schlegeli*. *Aquaculture* 231:457–468.
- Mori, H., M. Nakagawa, K. Soyano, and Y. Koya. 2003. Annual reproductive cycle of black rockfish *Sebastes schlegeli*, in captivity. *Fish. Sci.* 69:908–921.
- Nagasawa, T. 2001. Early life history of rockfishes (Genus *Sebastes*) in the Sea of Japan. *Bull. Japan Sea Natl. Fish. Res. Inst.* 51:1–132 [in Japanese with English abstract].
- Nakagawa, M. 1998. Juvenile production of black rockfish. Annual report of the Japan Sea-Farming Association in 1996, Tokyo, p. 160–161 [in Japanese].
- Nakagawa M. 1999a. Juvenile production of black rockfish. Annual report of the Japan Sea-Farming Association in 1997, Tokyo, p. 169–170 [in Japanese].
- Nakagawa, M. 1999b. Bloodstock management of black rockfish. Annual report of the Japan Sea-Farming Association in 1997, Tokyo, p. 34–36 [in Japanese].
- Nakagawa, M. 2000. Juvenile production of black rockfish. Annual report of the Japan Sea-Farming Association in 1998, Tokyo, p. 176–178 [in Japanese].
- Nakagawa, M. 2001. Juvenile production of black rockfish. Annual report of the Japan Sea-Farming Association in 1999, Tokyo, p. 158–159 [in Japanese].
- Nakagawa, M. 2002. Juvenile production of black rockfish. Annual report of the Japan Sea-Farming Association in 2000, Tokyo, p. 44 [in Japanese].
- Nakagawa, M. 2003. Juvenile production of black rockfish. Annual report of the Japan Sea-Farming Association in 2001, Tokyo, p. 53–54 [in Japanese].
- Nakagawa, M., and H. Okouchi. 2003a. The effects of density and feeding frequency on the intermediate culture of young black rockfish, *Sebastes schlegeli*. *Saibai Giken* 30:55–60 [in Japanese with English abstract].
- Nakagawa, M., and H. Okouchi. 2003b. Abnormal spawning of female black rockfish, *Sebastes schlegeli*, in the absence of copulation. *Saibai Giken* 30:75–77 [in Japanese with English abstract].
- Nakagawa, M., H. Okouchi, and J. Adachi. 2004. Stocking effectiveness of black rockfish *Sebastes schlegeli* released in Yamada Bay evaluated by a fish market census. In K. M. Leber, S. Kitada, H. L. Blankenship and T. Svåsand (eds.), *Stock enhancement and sea ranching*, p. 501–511. Blackwell, Oxford, UK.
- Nakagawa, M., and K. Hirose. 2004. Individually specific seasonal cycles of embryonic development in cultured broodstock females of the black rockfish, *Sebastes schlegeli*. *Aquaculture* 233:549–559.
- Nakagawa, M., and H. Okouchi. In press. Examination of embryonic developmental stage by cannulation to synchronize the timing of parturition in black rockfish *Sebastes schlegeli* broodstock females. *Aquacult. Sci.* 53 [in Japanese with English abstract].
- Shimizu, K. 1989. Juvenile production of black rockfish. Annual report of the Japan Sea-Farming Association in 1987, Tokyo, p. 175–176 [in Japanese].
- Shimizu, K. 1990. Juvenile production of black rockfish. Annual report of the Japan Sea-Farming Association in 1988, Tokyo, p. 194–195 [in Japanese].
- Shimizu, K. 1991. Juvenile production of black rockfish. Annual report of the Japan Sea-Farming Association in 1989, Tokyo, p. 150–151 [in Japanese].
- Shimizu, K. 1992. Juvenile production of black rockfish. Annual report of the Japan Sea-Farming Association in 1990, Tokyo, p. 181–182 [in Japanese].
- Shiozawa, S. 1985. Juvenile production of black rockfish. Annual report of the Japan Sea-Farming Association in 1984, Tokyo, p. 157–170 [in Japanese].
- Shiozawa, S. 1986. Juvenile production of black rockfish. Annual report of the Japan Sea-Farming Association in 1985, Tokyo, p. 178–180 [in Japanese].
- Shiozawa, S. 1988. Juvenile production of black rockfish. Annual report of the Japan Sea-Farming Association in 1986, Tokyo, p. 191–195 [in Japanese].
- Thuzaki, T. 1994. Juvenile production of Japanese flounder. Annual report of the Japan Sea-Farming Association in 1996, Tokyo, p. 121–123 [in Japanese].
- Yamada, J. and M. Kusakari. 1991. Staging and the time course of embryonic development in kurosoi, *Sebastes schlegeli*. *Env. Biol. Fish.* 30:103–110.

# Construction of a BAC Library from XY Japanese Flounder Using Frozen Sperm Genomic DNA

Hiroyuki Okamoto and Hiroyuki Nagoya

Eiichi Yamamoto  
Tottori Prefectural Fisheries Experimental Station  
Tomari, Tohoku, Tottori 689-0602, Japan

Takashi Sakamoto, Kanako Fuji, and Nobuaki Okamoto  
Tokyo University of Marine Science and Technology  
Konan, Minato, Tokyo 108-8477, Japan

Kazuo Araki  
National Research Institute of Aquaculture  
Tamaki, Mie 519-0423, Japan

Ichiro Nakayama  
National Research Institute of Fisheries Science  
Fukuura, Kanazawa, Yokohama 236-8648, Japan

**Keywords:** Japanese flounder, *Paralichthys olivaceus*, bacterial artificial chromosome, cosmid, frozen sperm, heterozygosity

## Abstract

Progress in genomic breeding for aquaculture requires several molecular genetics tools, which will facilitate analysis of genetic linkage and synteny or to clone genes associated with desirable commercial traits. Such tools include a recombination map, a physical (e.g., chromosome and radiation hybrid) map and genomic (bacterial artificial chromosome [BAC] and cosmid) libraries.

We have constructed BAC and cosmid libraries from the frozen sperm of Japanese flounder (*Paralichthys olivaceus*). The BAC library was generated from an XY male fish, the heterozygosity of which was confirmed by examination of the male:female ratio of its offspring. This BAC library contains DNA sequences from both the X and Y chromosome and will constitute a useful tool for the analysis of Y-specific genes. The sperm had been frozen in liquid nitrogen and stored in a freezer at  $-80^{\circ}\text{C}$  for more than one month. This study suggests that frozen fish sperm can be used in the construction of BAC or cosmid libraries even after prolonged storage. We have isolated several clones (e.g., major histocompatibility complex [MHC] class Ia) using the BAC library to analyze the synteny among fish species. Our results further indicate that freezing does not create a bias in the library.

## Introduction

The Japanese flounder (*Paralichthys olivaceus*) constitutes a key species for marine culture in Japan. It has a relatively well understood biology and a relatively small genome (approximately 0.71 pg/haploid [700 Mb]) (Ojima and Yamamoto 1990), which is shared among 24 chromosomes. This genome size is estimated as similar to medaka (*Oryzias latipes*) (850Mb), red sea bream (*Pagellus bogaraveo* or *Pagrus major*) (900Mb), and yellowtail (*Seriola quinqueradiata*) (800Mb), twice that of fugu (*Takifugu* spp., among others)

(390Mb), and one-half of the zebrafish (*Danio rerio*) (1.6Gb) genomes (Uwa and Iwata 1981, Brenner et al. 1993, Ojima and Yamamoto 1990, Ciudad et al. 2002). Therefore, flounder is a good model to understand aquaculture fish and to develop genomic breeding.

In a project of the Fisheries Research Agency “Genomic Breeding,” we have been producing genomic resources for Japanese flounder, including bacterial artificial chromosome (BAC) and cosmid libraries. The genomic libraries, having large insert



DNA, can facilitate rapid construction of a physical map and reduce the cost of structural analysis of large chromosomal regions. They can also help us find a responsible gene for a desirable commercial trait by positional cloning.

The original BAC library of Japanese flounder was constructed using the sperm of an XX homozygous cloned fish (Katagiri et al. 2000). However, that former BAC library had lost the Y chromosome, so we proceeded to construct a BAC library from an XY heterozygous flounder to get complete information from a set of all chromosomes. For this purpose we had to keep the sperm frozen for 7 months until we received the results of a heterozygosity test. In this study, we describe a BAC library made from a heterozygous flounder using its frozen sperm, and also a cosmid library as a DNA resource from an infectious disease-resistant fish.

## Methods and Materials

**Animals.** Japanese flounders for constructing the BAC libraries were obtained from the Tottori Prefectural Fisheries Experimental Station. They were comprised of five pairs of flounder that were mated one-to-one in June 2003, and whose offspring were reared until January 2004. For constructing the cosmid libraries, the flounder was an anti-*Edwardsiella* XX clone obtained from the Hyogo Prefectural Fisheries Experimental Station.

**Heterozygosity test of male fish.** Five male fish were designated TY-1 through TY-5 and their offspring were subjected to mild estradiol treatment (10 µg/l) for 2 hours every day from 15 June 2003 to 23 July 2003. The fish were observed from body lengths of 13–50 mm and from 34 to 72 days after hatching. A preliminary check of the sex ratio of the offspring was performed in December 2003 by observing the gonads of the fish. The final check was performed in January 2004.

**Freezing and defrosting of sperm.** Semen from the TY-1 through TY-5 fish was centrifuged in June 2003 to obtain a sperm pellet. We dispensed 300–500 µL of semen into a serum tube or a 2 ml centrifuge tube. The semen was centrifuged for 10 minutes at 2,000 g at room temperature (preferably at 4°C). The supernatant was carefully removed in ice. The sperm pellet in the tube was immediately frozen in liquid nitrogen. The tube was stored in a deep freezer at –80°C until October or December 2003.

To defrost the frozen sperm pellet, we incubated 5 ml of Egami's Ringers solution for marine fish at

30°C in a block incubator. The tube of frozen sperm was placed in the block incubator, and 1 ml of preheated Ringers solution was added. The tube was gently shaken with the sperm pellet. The thawed pellet was poured into the tube of the rest of the Ringers solution. The tube was transferred in ice and gently shaken again to initiate sperm dispersal without using a pipette. After removing the aggregates from the thawed sperm solution, we constructed the agarose plugs with the solution containing  $8 \times 10^8$  cells/plug. The agarose gel plug was constructed as described by Peterson et al. (2000).

**Construction and size estimation of BAC and cosmid library.** The BAC library was constructed by Geno Tech Co. (Tsukuba, Japan) using the agarose gel plugs from the frozen sperm of the TY-4 flounder and standard methods. The high molecular weight DNA in the agarose plug was partially digested with *Mbo*I. After a two-step size selection, the digested DNA was integrated into the pBAC3.6 vector.

The cosmid library was constructed with the Copy Control Fosmid library kit (Epicentre) from the frozen sperm of an anti-*Edwardsiella tarda* XX cloned Japanese flounder established at the Hyogo Prefectural Fisheries Experimental Station in 2002.

Analyses of insert size of BAC and cosmid clones were performed by pulse field gel electrophoresis (PFGE) using the fragments generated by *Not*I digestion containing the insert DNAs and BAC or cosmid vector.

## Results and Discussion

To check the heterozygosity of the male fish, we used five one-to-one mating pairs in June 2003, and checked the sex ratio of each offspring 7 months after fertilization. Before checking the sex ratio, the offspring were treated with mild estradiol as previously described. The estradiol treatment did not influence the XY fish to be male and repressed the XX fish from transforming to male because of water temperature. According to the data obtained from checking the sex ratio of the fish two times, the male:female sex ratio of the offspring of the TY-4 flounder was 53:47; the numbers of male and female offspring were 61 and 54, respectively.

We concluded the TY-4 flounder was a XY male fish, and proceeded to make a BAC library from the frozen sperm of TY-4. Because the mating season of flounder is only during spring, we stored the sperm until we could determine the sex ratio of the offspring

several months later. We froze the sperm of the five paternal fish in June 2003. After checking the sex ratio of the offspring, we prepared agarose plugs for constructing a BAC library, and placed an order for a library with Geno Tech Co. using the plugs. We checked that the length of the high molecular weight DNA of the agarose plug was more than 550 kb, which should be further evaluated for constructing the BAC library (Figure 1).

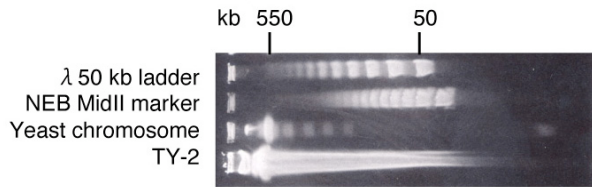
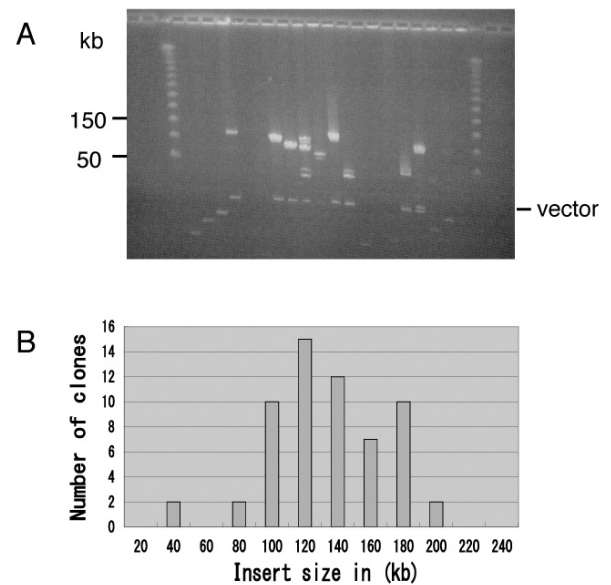

**Figure 1. Check length of high-molecular-weight DNA in agarose gel plug.**

The BAC library of TY-4 consisted of 110,592 clones arrayed in 288 microtiter plates with 384 wells. Analysis of insert size of the library was performed by PFGE using the fragments of BAC clones, which were produced by *NotI* digestion.

The insert size distribution is indicated in Figure 2b. The average insert size was calculated to be 140.7 kb. From the average insert size of this library (140.7 kb), the total number of clones (110,592), and the genomic size of Japanese flounder (approximately 700Mb) (Ojima and Yamamoto 1990), we estimated the coverage of our BAC library to be 22.2 times the size of the genome.

To check the quality of the BAC library, we preliminarily screened several genes from one-third of the BAC library (96 microtiter plates with 384 wells). First, we screened the major histocompatibility complex (MHC) genes, class Ia, Ib, II $\alpha$  and II $\beta$ , by polymerase chain reaction (PCR) assays from the super pools of BAC clone DNA or cell culture of the library directly. This PCR screening was performed by the primer sets from the cDNA sequences of MHC genes in Japanese flounder (Surisapooma et al. 2004). After checking each clone by sequencing, we found that two or three positive clones for each MHC gene were isolated from one-third of the BAC library (data not shown). Using the BAC clones, we can develop the microsatellite markers related with MHC genes from their sequences, and also analyze the synteny in the MHC regions between Japanese flounder and another fish species.

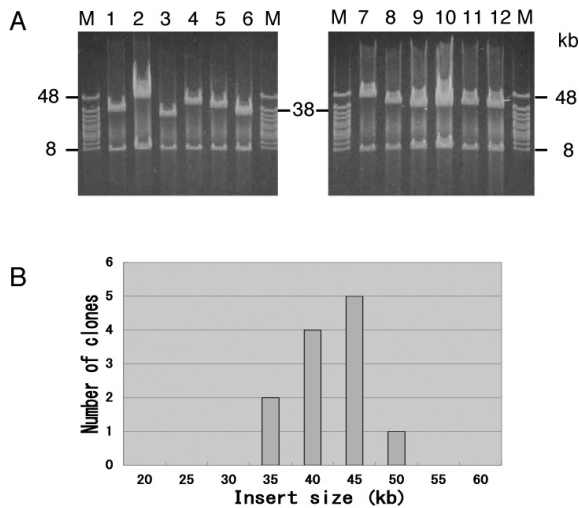

**Figure 2. Analysis of insert size of BAC clones of heterozygous Japanese flounder. (A) *NotI*-digested BAC DNAs and vector arm on PFGE. (B) Insert size distribution of the representative BAC clones.**

Second, we screened 24 microsatellite markers, which were associated with the 24 linkage groups (Coimbra et al. 2001, 2003). We could isolate at least one BAC clone for all 24 linkage markers (data not shown). The results showed that freezing the sperm does not create a chromosome bias. This study suggests that frozen fish sperm can be used in the construction of BAC libraries even after prolonged storage. This library is expected to clone a Y-chromosome specific DNA sequence, which is associated with sex determination.

We also constructed a cosmid library using the frozen sperm of anti-*Edwardsiella* XX homozygous clones of Japanese flounder. *Edwardsiella tarda* causes an infectious disease in marine fish, and severely damages the production of aquaculture. The anti-*Edwardsiella* fish have been selected after the challenge of the infectious bacteria and produced the XX homozygous clone by Hyogo Prefectural Fisheries Experimental Station in 2002. We constructed a cosmid library from the disease-resistant fish using its frozen sperm. Analysis of the insert size of the library was performed by PFGE using the fragments of cosmid clones, which were produced by *NotI* digestion (Figure 3A), and its size distribution is indicated in Figure 3B. The analysis indicated that the mean insert size was 39.5 kb, the maximum insert size was 48 kb, and the minimum insert size was 33 kb (Figure 3B). The cosmid

library consisted of 110,592 clones arrayed in 288 microtiter plates with 384 wells. From the average insert size of the library, the total number of clones and the genomic size of Japanese flounder, the analyses predicted that the cosmid library would be 6.2 times the size of the Japanese flounder genome. This library is useful to clone a specific DNA sequence, which is associated with the disease resistance.



**Figure 3. Analysis of insert size of cosmid clones of Anti-*Edwardsiella* XX clone fish. (A) *NotI*-digested cosmid DNAs and vector arm on PFGE. The vector size was estimated to be 7.4 kb. (B) Insert size distribution of the representative cosmid clones. The average, maximum, and minimum size of the insert DNA are 39.5, 48, and 33 kb, respectively.**

These genomic libraries are stored in the National Research Institute of Aquaculture or National Research Institute of Fisheries Science of Japan, and are available upon request for research purposes.

### Acknowledgments

The authors thank the Hyogo Prefectural Fisheries Experimental Station for providing the Japanese flounder XX clone fish. We also thank Drs. Masanori Okauchi, Takanori Kobayashi, and Kagayaki Morishima for providing technical support and Tomoyo Nozaki and Keiko Ikeyama for laboratory assistance. This research was supported by a grant from the Genomic Breeding Project by the Fisheries Research Agency of Japan.

### References

- Brenner, S., G. Elgar, R. Sandford, A. Macrae, B. Venkatesh, and S. Aparicio. 1993. Characterization of the pufferfish (*Fugu*) genome as a compact model vertebrate genome. *Nature* 366:265–268.
- Coimbra, M. R. M., O. Hasegawa, K. Kobayashi, S. Koretsugu, E. Ohara, and N. Okamoto. 2001. Twenty microsatellites for the Japanese flounder, *Paralichthys olivaceus*. *Fish. Sci.* 67:358–360.
- Coimbra, M. R. M., K. Kobayashi, S. Koretsugu, O. Hasegawa, E. Ohara, A. Ozaki, T. Sakamoto, K. Naruse, and N. Okamoto. 2003. A genetic linkage map of the Japanese flounder, *Paralichthys olivaceus*. *I* 220:203–218.
- Ciudad, J., E. Cid, A. Velasco, J. M. Lara, J. Aijón, and A. Orfao. 2002. Flow cytometry measurement of the DNA contents of G0/G1 diploid cells from three different teleost fish species. *Cytometry* 48:20–25.
- Katagiri, T., S. Asakawa, I. Hirono, T. Aoki, and N. Shimizu. 2000. Genomic bacterial artificial chromosome library of the Japanese Flounder *Paralichthys olivaceus*. *Mar. Biotechnol.* 2:571–576.
- Ojima, Y., and K. Yamamoto. 1990. Cellular DNA contents of fishes determined by flow cytometry. *La Kromosomo* II 57:1871–1888.
- Peterson, D. G., J. P. Tomkins, D. A. Frisch, R. A. Wing, and A. H. Paterson. 2000. Construction of plant bacterial artificial chromosome (BAC) libraries: An illustrated guide. *J. Agricul. Genomics*. Online at [www.ncgr.org/research/jag](http://www.ncgr.org/research/jag).
- Srisapoome, P., T. Ohira, I. Hirono, and T. Aoki. 2004. Cloning, characterization and expression of cDNA containing major histocompatibility complex class I, II $\alpha$  and II $\beta$  genes of Japanese flounder *Paralichthys olivaceus*. *Fish. Sci.* 70:264–276.
- Uwa, H., and A. Iwata. 1981. Karyotype and cellular DNA content of *Oryzias javanicus* (Oryziatidae, Pisces). *Chromosome Information Service* 31:24–26.

## **Status of Pacific Bluefin Tuna (*Thunnus orientalis*) Seed Production in Amami Station of NCSE FRA**

Hideki Nikaido, Takayuki Takebe, Kentaro Ide, and Hitoshi Imaizumi  
Amami Station National Center for Stock Enhancement  
Fisheries Research Agency  
955-5, Hyo Setouchi Oshima  
Kagoshima 894-2414 Japan  
nikaidoh@fra.affrc.go.jp

Nobuhiro Tezuka  
Notozima Station National Center for Stock Enhancement  
Fisheries Research Agency  
15-1-1 Magarimachi, Notozima  
Nanao, Ishikawa, 926-0216, Japan

Syukei Masuma  
Miyazu Station National Center for Stock Enhancement  
Fisheries Research Agency  
1721 Odasyukuno, Miyazu  
Kyoto, 626-0052, Japan

**Keywords:** bluefin tuna, *Thunnus orientalis*, seed production, stock enhancement

### **Abstract**

We have been developing seed production technology for bluefin tuna since 1995 and succeeded in rearing about 12,000 juveniles (average = 47 mm total length [TL] in 1998). However, the survival rate from hatching to the juvenile stage was typically only 0.1–0.3%. Three problems exist in seed production of bluefin tuna: viral nervous necrosis (VNN), 10 days after hatching (DAH) survival, and cannibalism occurring after 7 mm TL. The VNN was preventable by sterilizing fertilized eggs of bluefin tuna using residual oxidants in seawater and using oxidants in rearing chambers to sterilize the water. However, reasons and mechanisms of problems of the 10 DAH survival rate and cannibalism remained uncertain. We presumed that one factor affecting the 10 DAH survival rate is that bluefin larvae sink to the tank bottom during the night and subsequently die, but the cause remains unclear. We circulated the water by continuous pumping, which prevented the larvae from sinking. We examined a pump system and an aeration pipe system to produce water currents. Consequently, the 10 DAH survival rate in 2005 improved to 46%. The 10 DAH survival rate improved to greater than 60% in 2005.

Survival during rearing of the early larval stage improved greatly by prevention of VNN and improved the 10 DAH survival. Using these systems, seed production technology of bluefin larvae has been steadily developing and is anticipated to progress further.

### **Introduction**

Tuna is a marine product that is cherished worldwide; its popularity is not limited to Japan. Bluefin tuna, which has a very high market value, grows quickly and is the largest of the tunas. The bluefin is an extremely important Japanese fishery resource. The bluefin tuna is also an international fishery resource for other countries. For these reasons, management of bluefin has been entrusted to international committees. Japan's government,

which serves a large market for bluefin, has promoted the development of stock enhancement techniques for propagation of wild resources of bluefin tuna. Three obstacles hinder bluefin tuna seed production: viral nervous necrosis (VNN), the 10 days after hatching (DAH) survival rate, and cannibalism occurring after the larvae reach 7 mm total length (TL). The first of those, VNN, is preventable using sterilized fertilized bluefin tuna eggs with residual

oxidants in seawater (Takebe et al. 2004, Imaizumi et al. in press) and by the use of oxidant-sterilized seawater as rearing water (Tezuka et al. 2004). However, the causes and mechanisms associated with the problems of 10 DAH survival rate and cannibalism are unclear.

We presumed that one cause of death before 10 DAH is that bluefin larvae sink to the tank bottom during the night and subsequently die, but the root cause remains uncertain. To address the problem, we decided to use a method of circulating water continuously using a current generator to prevent larvae from sinking. We produced currents using a pump system and an aeration pipe system. We examined the 10 DAH survival rate, the current direction and speed, and the distribution of bluefin tuna larvae with respect to water depth. This paper presents the results of those studies with respect to improvement of 10 DAH survival.

## Materials and Methods

**Fertilized eggs and hatching method.** Takuyo Co. Ltd. and Kinki University provided fertilized eggs of bluefin tuna used for seed production; some were collected from broodstock at Amami Station. A polycarbonate Artemia hatching tank (200 L) was used. We sterilized fertilized eggs using residual oxidants (0.3 mg/L) in seawater before placement in the hatching tank. The eggs were hatched in oxidant-sterilized seawater.

**Rearing tanks and seawater.** We used octagonal concrete rearing tanks (50,000 L) at Amami Station for this study. All seawater used for rearing bluefin tuna larvae was sterilized using oxidants (0.5 mg/l) generated in the seawater by electrolysis. We used activated carbon to absorb residual oxidants.

**Current generation method.** We tested a method that allowed continuous rotation using two devices. One used a pump, the other used aeration pipes that are usually used for rearing fish.

**Pump system.** The pump system (Figure 1) is made of one pump put in a strainer in the center of the rearing tank and crossed plastic pipes with holes (1.0 mm) at 10 cm intervals. Plastic pipes were placed on the bottom of the rearing tank, and then turned upward at 40–50° angles. The rearing seawater spouts were formed from holes in the plastic pipe, producing an upward current. We used air stones for aeration.

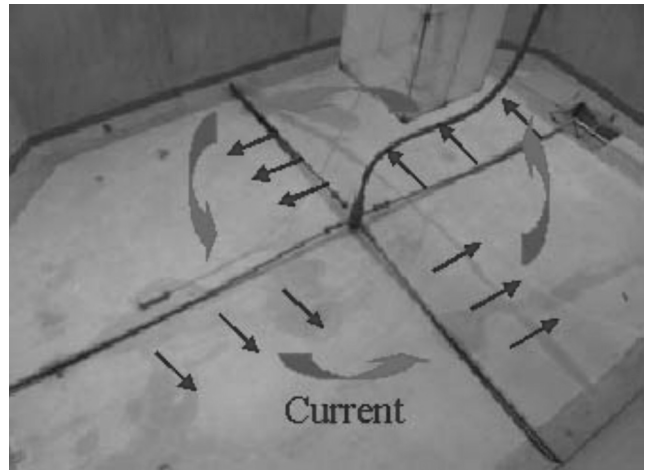

**Figure 1. Photo of pump system.** The small arrows show the directions of flow of sea water and the larger arrows show the current flow.

**Aeration pipe system.** The aeration pipe system (Figure 2) is comprised of 1 m long, 25 mm diameter air sprayer hoses. We placed 4–8 pipes on the bottom side of the wall of the rearing tank to produce an upward current by aeration. We did not attach air stones.

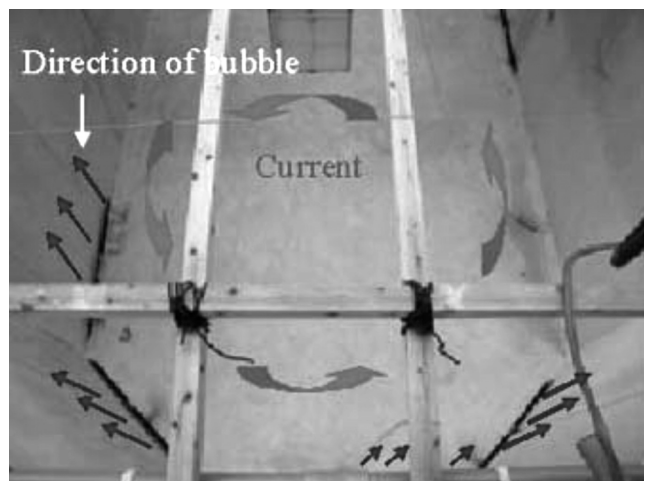

**Figure 2. Photo of aeration the aeration system.** The small arrows show air flow directions and the larger arrows show the current direction.

**Measurement of current direction and speed.** We divided the rearing tank bottom into 16 areas and measured the current direction and speed at the same point of each area. Depths of the measurement points were set at 5 cm, 30 cm, 1 m, and 2.5 m from the tank bottom. We used an electromagnetic current meter (ACM-300A, Alec Electronics Co. Ltd.) for measurements.

**Larval distribution.** We measured the distribution density of larvae at specific points within the tank. Depths measurement points were 30 cm, 50 cm, 1 m, 1.5 m, 2 m, and 2.5 m from the surface. We used 16 mm inside diameter plastic pipes for larvae sampling. The distribution density was calculated using the number of larvae per liter of water. The survey was conducted at 1100 hours and 2100 hours on 3 DAH and 6 DAH.

## Results

In 2005 we reared larvae four times using the pump system and twice using the aeration pipe system (Table 1). We compared results using fertilized eggs of identical origin with rearing case-2R.

**Table 1.**

Rearing Cases	No. of Tanks	Methods of current generation	Origin of Eggs	Start		10 DAH	
				Date	No. of larvae (<10,000)	No. of larvae (<10,000)	Survival rate (%)
1R	50kl-8	Pump	Takuyo	2005/7/14	52.1	10.7	20.5
2R-1	50kl-4	Pump	Takuyo	2005/7/16	80.0	28.7	35.9
2R-2	50kl-2	Aeration pipes	Takuyo	2005/7/16	80.0	4.4	5.5
2R-3	50kl-5	Pump	Takuyo	2005/7/16	80.0	49.9	62.4
2R-4	50kl-6	Aeration pipes	Takuyo	2005/7/16	80.0	5.0	6.3
3R	50kl-1	Pump	Kinki Univ.	2005/7/24	32.7	9.0	27.5
Total					404.8	108	26.61

**Survival of larvae.** The 10 DAH survival rates using the pump system were 35.9% and 62.4%. The 10 DAH survival rates using the aeration pipe system were 5.5% and 6.3%. Rearing results showed that the pump system provided much higher survival rates than the aeration pipe system (Figure 3). Particularly noteworthy is that the 62.4% result of 2R-3 became the highest result ever recorded for rearing at Amami Station. The 10 DAH survival rate ranged from 20.5% to 62.4% for the pump system in all rearing cases including when we used fertilized eggs of different origin. This result was considerably higher than the 5.5% and 6.3% results achieved by the aeration pipe system (Figure 4).

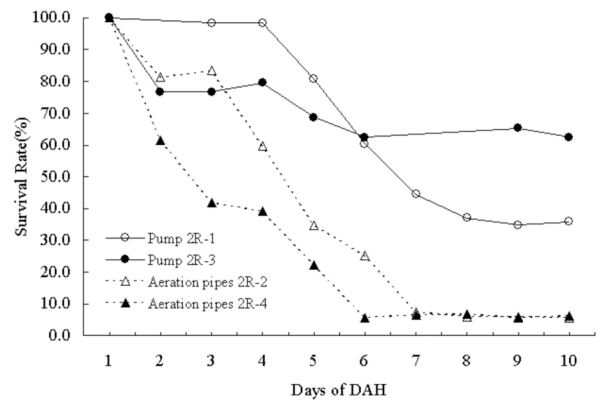

**Figure 3.** Comparison between survival rates of bluefin larvae using two ways of generating water currents. (All eggs were from the same origin.)

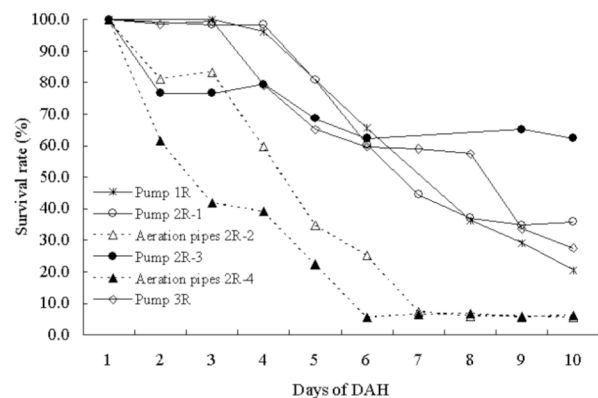

**Figure 4.** Comparison between survival rates of bluefin larvae using two ways of generating water currents in tanks. (Origin of eggs was not the same in all cases.)

**Measurement of current direction and speed.** We measured the direction and speed of the current in rearing water (Figure 5). Results for the pump system showed a tendency for a strong upward current from the bottom of the rearing tank. The current speed was about 4–9 cm/s upward. With the aeration pipe system, the upward current speed from the bottom of the rearing tank was slower, about 2–5 cm/s, and the current direction was irregular.

**Larval distribution.** We measured the larval distribution density for every depth 3 DAH and 6 DAH. With the pump system, the density of larvae at 1100 hours on the third DAH was similar from the surface to 1.5 m depth. Larvae were present at the 2 m depth, but distribution density was reduced. Larvae were almost absent at the bottom of the rearing tank using the pump system. At 2100 hours, the larvae were uniformly distributed from the surface to 2.0 m

depth and were rare at the rearing tank bottom (Figure 6).

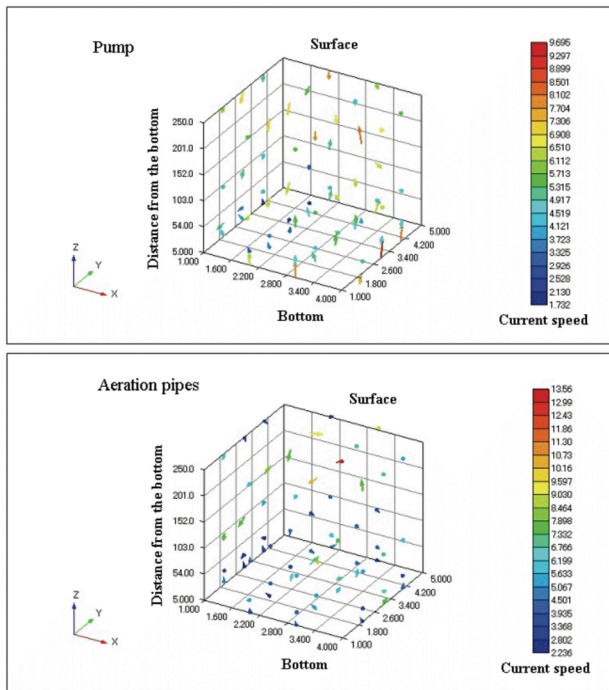

Figure 5. Current direction and speed in rearing tanks using two methods to generate currents. The arrows show direction of the currents.

The densities of bluefin larvae at 1100 hours and 2100 hours were almost identical from the surface to 50 cm depth. Few larvae were found at the bottom of the rearing tank (Figure 7).

In the aeration pipe system, larval density at 1100 hours on the third DAH was flat from the surface to 2.0 m depth; larvae were present at the rearing tank bottom but the density was low (Figure 6). The density of bluefin larvae at 1100 hours and 2100 hours on the sixth DAH with the aeration pipe system was almost identical from the surface to 50 cm depth and density at the rearing tank bottom was low (Figure 7).

## Discussion

Regarding prevention of the low 10 DAH survival rate, Tezuka et al. (2005) examined the effects of light on the surface and current of rearing seawater from 1999 to 2001. Results showed the necessity of surface illumination at more than 800 lux and the current speed of the rearing seawater at 1–2 m/s. It is possible to maintain average illuminance over 800 lux, as Tezuka et al. (2005)

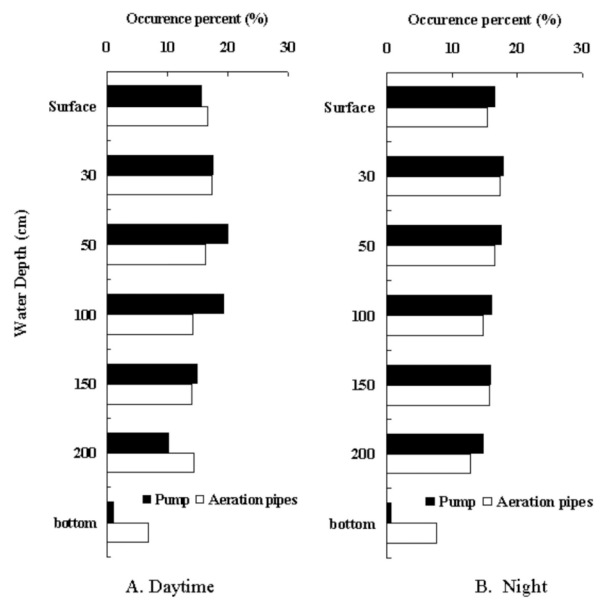

Figure 6. Density of larvae as a function of depth in the tank 3 DAH.

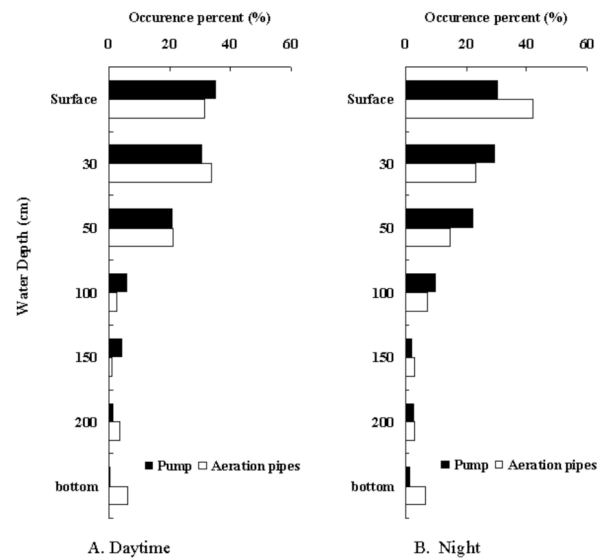

Figure 7. Density of larvae as a function of depth 6 DAH.

reported, by taking natural light from the top of the rearing tank. Beginning in 2004, we examined the effects and production methods for providing a current in the rearing tanks. We succeeded in preventing bluefin larvae from sinking to the tank bottom by producing a water current with a pump system. We demonstrated improvement of the 10 DAH survival rate. The rate improved to 40% in 2003, but was about 10% in 2000, subsequently improving to a 60% 10 DAH survival rate in 2005.

The purpose of generating the current is to prevent the bluefin larvae from sinking to the bottom of the



rearing tanks. Sakamoto and Takashi (2005) reported that bluefin tuna larvae tend to sink during the day, and float at night. However, during rearing, bluefin larvae sink to the bottom of the rearing tank and die at night in most cases. This phenomenon is not explainable by gravity fluctuation, as Sakamoto and Takashi (2005) suggested. They reported that bluefin tuna larvae are prevented from sinking by swimming actively for feeding during the day; larvae sink because of weak swimming during the night. We determined that the effect of the pump system prevented bluefin larvae from sinking to the bottom of rearing tanks and dying by forcibly pushing them upward using a current.

We prevented the VNN problem and solved the low 10 DAH survival rate, thereby finding solutions to two of the three salient problems inherent in rearing bluefin larvae. As a result, the survival rate for rearing early larval stage improved substantially. The cannibalism problem, however, remains unsolved and will continue as an important subject for future study. We are reviewing the feeding protocol to determine if there is a way to mitigate growth differences of larvae and thereby control cannibalism at TL 7 mm. It appears possible to delay cannibalism by delaying the rotifer period, providing the bluefin larvae with larval brine shrimp (*Artemia nauplii*), and delaying the start of live feeding.

Existing trials show steadily improved results and present the possibility of mass production of seedlings. From here, we will examine seed production techniques, other measures of mass and healthy seed production techniques, and secure genetic diversity, which will be described in future reports.

## Acknowledgments

Special appreciation is extended to Takuyo Co., Ltd. and the Amami laboratory of Kinki University for providing valuable fertilized bluefin tuna eggs.

## References

- Takebe, T., S. Masuma, N. Tezuka, H. Nikaido, and K. Ide. 2004. Hatching management on fertilized eggs of blue fin tuna *thunnus orientalis* disinfected by ozonated seawater. NCSE Technical Report (tentative) 1:80–83.
- Imaizumi, H., T. Takebe, H. Nikaido, K. Ide, and S. Masuma. In press. Effect of low level residual oxidants in seawater on hatching of fertilized eggs of bluefin tuna *Thunnus orientalis*. NCSE Technical Report (tentative).
- Tezuka, N., S. Masuma, T. Takebe, H. Nikaido, and K. Ide. 2004. Control of Viral Nervous Necrosis (VNN) using ozonated seawater in seedling production of bluefin tuna, *Thunnus orientalis*. NCSE Technical Report (tentative). 1:76–79.
- Tezuka, N., M. Koiso, S. Masuma, T. Takebe, H. Nikaido, and K. Ide. 2005. Effect of water current and light on survival of larval bluefin tuna, *Thunnus orientalis*. NCSE Technical Report (tentative), 3:41–44.
- Sakamoto, W., and T. Takashi. 2005. Gravity changes of bluefin larvae. The interim research reports of 21st Century COE Program, Center of Aquaculture Science and Technology for Bluefin Tuna and Other Cultivate Fish, in 2003–2004, p. 113–116. Fisheries Laboratory & Graduate School of Agriculture, Kinki University.





# Visualization Tools to Probe Early Stage Fish Abnormalities

Susumu Uji and Tadahide Kurokawa  
National Research Institute of Aquaculture  
Research Agency, 422-1  
Minami-ise, Watarai  
Mie 516-0193, Japan  
uji@fra.affrc.go.jp

**Keywords:** abnormality, antibody, histochemical staining, visualization

## Abstract

The incidence of malformed fish is an important problem in the seed production of many species. The abnormal appearance of fish can be judged only when they have become large because examination or measurement of the miniscule exterior, jaws, faces, etc., of embryos and larvae is difficult. If abnormalities occur frequently, then unnecessary expenditures of human resources, money, and time must be undertaken to raise fish to sufficient size for examination. That waste would be eliminated if we could judge malformation at an early stage. To this end, we are developing rapid malformation judgment methods for fish in embryo and larval stages.

Malformations are now discovered only at later growth stages, but we infer that they occur mainly during abnormal organogenesis at early stages. These malformations are detectable in early stages using visualization tools for specific organs and cells. Antibodies and histochemical staining methods are suitable for that purpose because they are effective with many fish simultaneously. Many antibodies and histochemical staining methods are useful for commercial sea fishes. For example, antibodies to acetylated tubulin, to a cell surface marker (HNK-1), and to Na K-ATPase ( $\alpha 5$ ) are useful, respectively, to visualize the nervous system, neural crest cells, and kidney in fugu (*Fugu rubripes*), also known as puffer fish, yellowtail (*Seriola quinqueradiata*), and Japanese eel (*Anguilla japonica*). Calcein and alkaline phosphatase staining methods are also useful to visualize bones and intestines. Using these tools to probe abnormalities, we can work efficiently to solve malformation problems.

## Introduction

A considerable number of studies over many years have examined wild and reared fish abnormalities (Dawson 1964, Dawson 1966, Dawson 1971a, b). Nevertheless, numerous malformed fish exist in hatchery production throughout the world (Komada 1980, Koumoundouros et al. 1997, Boglione et al. 2000, Cobcroft et al. 2001 and 2004, Fraser et al. 2005). Malformed fish are a significant problem for the aquaculture industry because malformations are often associated with growth depression and high mortality rates (Barahona-Fernandes 1982, Andrades et al. 1996). Their incidence engenders unnecessary expenditures of resources, money, and time required to raise fish in the hatchery. Fish with malformations also depress prices and lower market demand.

Despite their importance, the causes of abnormalities remain poorly understood. Genetic, environmental, and nutritional causes have been suggested as possible sources of abnormalities. For example, genetic factors have been reported to cause

developmental abnormalities (Kincaid 1976, Gjerde et al. 2005). Environmental factors such as mechanical or thermal shock, salinity, and oxygen depletion also have been reported to cause developmental abnormalities (Alderdice et al. 1958, Garside 1959, Doroshev et al. 1974, Lee et al. 1981, Divanach et al. 1997). Several dietary components, such as fatty acids or vitamins, affect these abnormalities (Cahu et al. 2003). Although many studies exist, most examine environmental and nutritional factors, especially at the juvenile stage. Almost none address maternal factors at early developmental stages.

This study specifically examines this early stage—especially maternal factors—until the fish have a first feeding. Previous studies have shown that egg quality is a critical factor for survival (Kjørsvik et al. 1990, Furuita et al. 2003, Aegerter et al. 2004). Most organ systems develop during the early stages of organogenesis, when organs such as limbs, eyes, and gills develop (Gilbert 2003).

Consequently, aberrant development during that period creates living but abnormal fish. During organogenesis, which occurs before young fish begin to feed, the embryo develops using only egg nutrition. Most humans and domestic animals also have congenital malformations (Noden et al. 1985, Moore et al. 1998).

Abnormal development is believed to be influenced by maternal factors that engender fish malformation, but no adequate technique exists to assess such problems. The embryo is extremely small and too transparent to check for abnormalities; we can obtain little information about abnormalities using only a microscope. With this consideration, we developed visualization tools to probe for early stage abnormalities.

This paper represents a compilation of antibody and histochemical staining methods we used to visualize tissues of various fish species. We also propose a concept to facilitate solving malformation problems.

### Antibody Staining Methods

Embryos are extremely small and are too transparent to allow checking for abnormalities. For those reasons, we can obtain little information about abnormalities merely by using microscopy. To date, assessment of abnormalities has been conducted in most hatcheries at later stages, such as the larval or juvenile stages.

Visualization tools are needed to detect abnormalities at earlier stages such as the embryo or early larval stages. Visualization tools must also be readily available for many kinds of fishes. Antibody and histochemical staining methods meet those requirements. Using such methods, we can visualize their structural information. These methods are useful for many kinds of fishes. Moreover, we can deal with numerous fish simultaneously.

The availability of antibodies and histochemical staining methods against specific cell lineages facilitates the identification and localization of different organs and cells among species (Table 1). Furthermore, because of their small size, whole fish histology can be performed to examine for abnormalities.

Immunohistochemical analyses were performed using six antibodies: anti-MF-20, anti-HuC/HuD antibody, anti-HNK-1 antibody, anti-acetylated tubulin antibody, anti-a5 antibody, anti-myosin heavy chain, and clone A4 1025 antibody (Figure 1). We performed experiments on four teleost species: fugu

**Table 1. Staining method for analysis of abnormal development in fish.**

Antibody	Organs or cells	J	Y	F	Z
a5	kidney and chloride cell	+	+	+	+
acetylated tubulin	nervous system	+	+	+	+
HuC/HuD	nervous system	+	+	+	+
HNK-1	neural crest cells	+	+	+	+
MF-20	muscle	+	+	+	+
myosin	muscle	+	+	+	+
Histochemical technique					
alcian blue	cartilage	+	+	+	+
alizarin red	bone	+	+	+	+
alkali phosphatase	endothelial cell	+	+	+	not
calcein	skeleton	+	not	not	+
zudan black B	blood vessel system	+	not	not	not
J: Japanese eel    Y: Yellowtail    not: not tested F: Fugu            Z: Zebrafish					

(*Fugu rubripes*), zebrafish, (*Danio rerio*), Japanese eel, (*Anguilla japonica*), and yellowtail, (*Seriola quinqueradiata*). All these antibodies react in all teleosts that we examined and antigens derived from nonteleost species such as mammalian species. These antibodies probably react in teleosts at least.

For example, anti-HuC/HuD antibody stains neuronal cells in all organisms that we examined. The antibody binds specifically to antigens that are present exclusively in neuronal cells and are therefore useful as markers of neuronal cells in tissues. Some abnormal fish phenotypes appear to resemble human neurocristopathies. Neurocristopathies are neural-crest-cell diseases in humans. Neural crest cells originate at the dorsal-most regions of the neural tube, migrate extensively, and eventually give rise to a remarkable variety of cell types, including neurons and glial cells, cartilage, pigment cells, and chromaffin cells. Anti-HNK-1 monoclonal antibody recognizes a carbohydrate epitope on subpopulations of several cell-adhesion molecules including N-CAM and MAG. Neural crest cells express this N-CAM. Consequently, neural crest cells can be stained using this antibody (Suzuki et al. 2003, Ishikawa et al. 2004). The monoclonal antibody against  $\alpha$ -acetylated tubulin stains early axons and young somata of neurons immunohistochemically (Ishikawa et al. 2004). Anti-a5 antibody recognizes the  $\alpha$ -subunit of the sodium potassium ATPase (Na, K-ATPase, Lebovitz et al. 1989). This protein is pivotal to various physiological processes, including osmoregulation, cell volume regulation, transport of certain amino acids and sugars, and maintenance of membrane excitability. This method enables the visualization of kidney and chloride cells.

In addition, MF-20 antibody reacts with all sarcomere myosin (Bader et al. 1982). It is possible to view myotomes; thereby, one can speculate that

somites give rise to muscles and the vertebral column, as well as the epidermal tissues. The anti-myosin heavy chain (clone A4 1025) antibody stains myotomes and cardiac muscle. It allows visualization not only of myotomes and cardiac muscle, but also eye muscles such as the superior oblique, inferior oblique, superior rectus, and inferior rectus. All six pairs of these eye muscles are visible, in addition to pharyngeal muscles at later stages.

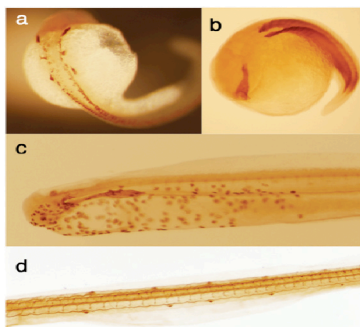

**Figure 1.** Examples of whole mount immunohistochemical staining: a, anti-HuC/HuD antibody reacts in zebrafish embryo; b, anti-myosin heavy chain, clone A4 1025 antibody reacts in fugu; c, anti-a5 antibody reacts in Japanese eel; and d, anti-acetylated tubulin antibody reacts in Japanese eel.

### Histochemical Staining Methods

The histochemical staining method is more useful to assess abnormalities for many kinds of fishes. Bone and cartilage are stained, respectively, using the alizarin red method and alcian blue method. These well-known histochemical staining methods are useful as visualization tools to probe fish abnormalities. Calcein is a fluorescent chromophore that binds specifically to calcium (Du et al. 2001). This method has an advantage in that it can be used to follow the development of skeletal systems in living embryos.

The alkaline phosphatase staining method visualizes the intestine. Fish exhibit high levels of endogenous alkaline phosphatase, which renders them detectable simply by enzymatic staining (Serbedzija et al. 1999). Alkaline phosphatase exists mainly in endothelial cells. Thus endothelial cells that line the blood vessel lumen are visible, but we can see only the intestine and osteoblasts, which have high levels of endogenous alkaline phosphatase at the base of the tooth. That limitation notwithstanding, the method is sufficient because it allows inspection of the intestines. The sudan black B staining method shows the blood vessels of intestines. Originally, sudan black B stain was used to stain general fat in

human blood tests; using it, we can readily view blood vessels in whole mounted samples.

### Concept to Resolve Fish Malformation Problems

Several important factors appear to affect the fish in early developmental stages. These factors are classifiable as genetic, maternal, and environmental. Perhaps all of them cause malformation. The times at which these factors exert their respective influences are also important. First, to approach these problems, we specifically examine only maternal factors at the embryo stage. Then we hypothesize that abnormal development by maternal factors is a major cause of malformed fish. So far, however, we have only judged malformation when fish are sufficiently large to verify their shape; at this stage, it remains unclear whether fish that are being raised are normal or abnormal. As explained earlier, it is very inefficient to raise abnormal fish. Some judgment can be made earlier if the above hypothesis is correct. Figure 2 shows a simplified scheme of an early batch checking strategy with fish embryos.

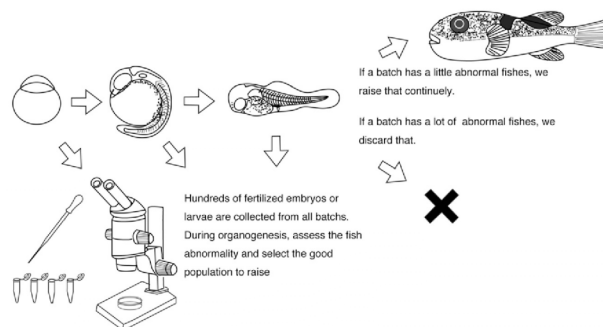

**Figure 2.** Simplified scheme of an early batch checking strategy.

Because of their small size, the entire checking procedure can be accomplished within 2 days, and the cost of this checking procedure is low. If development could be judged earlier, we could select good populations to raise, thereby eliminating the waste of resources, money, and time in raising abnormal fish to a sufficient size to allow examination. Environmental factors could also be assessed, such as mechanical or thermal shocks, salinity, and oxygen depletion, in terms of their effects on normal organ development of fish using these visualization tools. The effects of drugs and chemicals on growth and development could be assessed in detail by examining the size and morphology of internal organs such as the brain,

muscle, intestines, and kidneys using these visualization tools.

In summary, this study revealed that many antibody and histochemical staining methods are useful for visualization of many, perhaps nearly all, fishes. This paper also presented a new concept to resolve malformation problems.

## Acknowledgments

We thank Tohru Suzuki, Hisashi Hashimoto, and Keiichi Mushiake for useful suggestions. The authors are grateful to Hideki Tanaka and Yoshitomo Nagakura for providing Japanese eel and yellowtail samples, respectively. The MF-20 antibody and a5 antibody developed by Donald A. Fischman and Douglas M. Fambrough, respectively, were obtained from the Developmental Studies Hybridoma Bank developed under the auspices of the National Institute of Child Health and Human Development and maintained by the University of Iowa, Department of Biological Sciences, Iowa City, Iowa. This study was supported in part by a grant-in-aid from the Bio-Design Program and Development of Seed Production Technology in Japanese Eel and Japanese Spiny Lobster Project of the Japanese Ministry of Aquaculture, Forestry, and Fisheries.

## References

- Aegerter, S., and B. Jalabert. 2004. Effects of post-ovulatory oocyte ageing and temperature on egg quality and on the occurrence of triploid fry in rainbow trout, *Oncorhynchus mykiss*. *Aquaculture* 231:59–71.
- Alderdice, D. F., W. P. Wickett, and J. R. Brett. 1958. Some effects of temporary exposure to low dissolved oxygen levels in Pacific salmon eggs. *J. Fish. Res. Board Can.* 15:229–249.
- Andrades, J. A., J. Becerra, and P. Fernandez-Llebrez. 1996. Skeletal deformities in larval, juvenile, and adult stages of cultured gilthead sea bream (*Sparus aurata*). *Aquaculture* 141:1–11.
- Bader, D., T. Masaki, and D. A. Fischman. 1982. Immunochemical analysis of myosin heavy chain during avian myogenesis *in vivo* and *in vitro*. *J. Cell Biol.* 95:763–770.
- Barahona-Fernandes, M. H. 1982. Body deformation in hatchery reared European sea bass *Dicentrarchus labrax*: Types, prevalence, and effect on fish survival. *J. Fish Biol.* 21:239–249.
- Boglione, C., F. Gagliardi, M. Scardi, and S. Cataudella. 2000. Skeletal descriptors and quality assessment in larvae and post-larvae of wild-caught and hatchery-reared gilthead sea bream (*Sparus aurata*). *Aquaculture* 192:1–22.
- Cahu, C., J. Z. Infante, and T. Takeuchi. 2003. Nutritional components affecting skeletal development in fish larvae. *Aquaculture* 227:245–258.
- Cobcroft, J. M., P. M. Pankhurst, C. Poortenaar, and B. Hickman. 2004. Jaw malformation in cultured yellowtail kingfish (*Seriola lalandi*) larvae. *N. Z. J. Mar. Freshw. Res.* 38:67–71.
- Cobcroft, J. M., P. M. Pankhurst, J. Sadler, and P. R. Hart. 2001. Jaw development and malformation in cultured striped trumpeter *Latris lineata*. *Aquaculture* 199:267–282.
- Dawson, C. E. 1964. A bibliography of anomalies of fishes. *Gulf Res. Rep.* 1:308–399.
- Dawson, C. E. 1966. A bibliography of anomalies of fishes: Supplement 1. *Gulf Res. Rep.* 2:169–176.
- Dawson, C. E. 1971a. A bibliography of anomalies of fishes: Supplement 2. *Gulf Res. Rep.* 3:215–239.
- Dawson, C. E. 1971b. A bibliography of anomalies of fishes: Supplement 3. *Gulf Res. Rep.* 5:35–41.
- Divanach, P., N. Papandroulakis, P. Anastasiadis, G. Koumoundouros, and M. Kentouri. 1997. Effect of water currents on the development of skeletal deformities in sea bass (*Dicentrarchus labrax*) with functional swim bladders during postlarval and nursery phase. *Aquaculture* 156:145–155.
- Doroshev, S. I., and T. M. Aronovich. 1974. The effects of salinity on embryonic and larval development of *Eleginus navaga* (Pallas), *Boreogadus saida* (Lepechin) and *Liopsetta glacialis* (Pallas). *Aquaculture* 4:353–362.
- Du, S. J., V. Frenkel, G. Kindschi, and Y. Zohar. 2001. Visualizing normal and defective bone development in zebrafish embryos using the fluorescent chromophore calcein. *Dev. Biol.* 238:239–246.
- Fraser, M. R., and R. de Nys. 2005. The morphology and occurrence of jaw and operculum deformities in cultured barramundi (*Lates calcarifer*) larvae. *Aquaculture* 250:496–503.
- Furuita, H., T. Yamamoto, T. Shima, N. Suzuki, and T. Takeuchi. 2003. Effect of arachidonic acid levels in broodstock diet on larval and egg quality of Japanese flounder *Paralichthys olivaceus*. *Aquaculture* 220:725–735.

- Garside, E. T. 1959. Some effects of oxygen in relation to temperature on the development of lake trout embryos. *Can. J. Zool.* 37:689–698.
- Gilbert, S. F. 2003. *Developmental Biology*, 7th edition. Sinauer Associates Inc., Sunderland, Massachusetts.
- Gjerde, B., M. J. R. Pante, and G. Baeverfjord. 2005. Genetic variation for a vertebral deformity in Atlantic salmon (*Salmo salar*). *Aquaculture* 244:77–87.
- Ishikawa, Y., T. Kage, N. Yamamoto, M. Yoshimoto, T. Yasuda, A. Matsumoto, K. Maruyama, and H. Ito. 2004. Axonogenesis in the medaka embryonic brain. *J. Comp. Neurol.* 476:240–253.
- Kincaid, H. L. 1976. Inbreeding in rainbow trout (*Salmo gairdneri*). *J. Fish. Res. Board Can.* 33:2420–2426.
- Kjørsvik, E., A. Mangor-Jensen, and I. Holmefjord. 1990. Egg quality in fishes. *Adv. Mar. Biol.* 26:71–113.
- Komada, N. 1980. Incidence of gross malformations and the vertebral anomalies of the natural and hatchery *Plecoglossus altivelis*. *Copeia* 1:29–35.
- Koumoundouros, G., G. Oran, P. Divanach, S. Stefanakis, and M. Kentouri. 1997. The opercular complex deformity in intensive gilthead sea bream (*Sparus aurata*) larviculture: Moment of apparition and description. *Aquaculture* 156:165–177.
- Lebovitz, R. M., K. Takeyasu, and D. M. Fambrough. 1989. Molecular characterization and expression of the (Na<sup>+</sup> + K<sup>+</sup>)-ATPase alpha-subunit in *Drosophila melanogaster*. *Embo. J.* 8:193–202.
- Lee, C. S. and B. Menu. 1981. Effects of salinity on egg development and hatching in grey mullet (*Mugil cephalus*). *J. Fish Biol.* 19:179–188.
- Moore, K., and T. V. N. Persaud. 1998. *Before we are born: Essentials of embryology and birth defects*. 4th edition. WB Saunders Co., Philadelphia, Pennsylvania.
- Noden, D. M. and A. D. Lahunta. 1985. *Embryology of domestic animals: Developmental mechanisms and malformations*. Williams & Wilkins Co., Baltimore, Maryland.
- Serbedzija, G. N., E. Flynn, and C. E. Willett. 1999. Zebrafish angiogenesis: A new model for drug screening. *Angiogen.* 3:353–359.
- Suzuki, T., Y. Haga, T. Takeuchi, S. Uji, H. Hashimoto, and T. Kurokawa. 2003. Differentiation of chondrocytes and scleroblasts during dorsal fin skeletogenesis in flounder larvae. *Dev. Growth Differ.* 45:435–448.



# Airlift-PolyGeyser Combination Facilitates Decentralized Water Treatment in Recirculating Marine Hatchery Systems

Ronald F. Malone and Sripavani Gudipati  
Department of Civil and Environmental Engineering  
Louisiana State University, Baton Rouge, Louisiana 70803-6405  
Rmalone@LSU.edu

**Keywords:** Marine hatcheries, recirculation; biofiltration, airlifts, bead filters, PolyGeyser

## Abstract

The nature of reproduction in fecund marine species demands that careful attention be given to the conditioning of broodstock, culture of sensitive larval stages, and production of healthy, properly sized fingerlings. Hatchery operations generally demand pristine waters and have been found to be particularly sensitive to biosecurity issues. The trend is toward the design of systems that are capable of meeting more rigorous water quality expectations in recirculating formats that display a high degree of water reuse. Traditional treatment sequences consisting of bead filters, fluidized beds, packed columns, and often pure oxygen injection systems have served the research community. These systems have also been successfully applied in the commercial production of shrimp postlarvae and ornamental fish.

Increasing concerns about biosecurity are encouraging the examination of more decentralized approaches to water treatment. One such partitioned approach utilizes a pneumatic PolyGeyser floating bead filter (Aquaculture Systems Technologies LLC, New Orleans, Louisiana) in combination with airlifts to meet core recirculating needs. Use of airlifts allows the centralization of utilities without the potential of cross contamination of waters from diverse tank systems. The PolyGeyser filters are pneumatically washed in a manner that permits the recycling of backwash water, thus reducing the need for water replenishment. Sizing criteria for the bead filters, tanks, and airlift systems are provided to facilitate evaluation in the commercial sector.

## Introduction

It can be anticipated that future marine production facilities will consist of recirculating hatcheries coupled with larger scale ponds, tanks, or net pen operations (Malone 2002). Recirculating systems are expected to continue to play an important role in conditioning broodstock, supporting larval stages, and rearing fingerlings as marine aquaculture production expands. These closed marine systems will have to be operated in a biosecure manner, thereby assuring the health of broodstock and fingerlings that must be held for extended periods of time. Water quality expectations will be high, reflecting the high value placed upon healthy, properly sized fingerlings for stocking growout facilities. A variety of existing recirculating designs will be adapted to meet the needs of marine hatchery systems. Recirculating systems will have to be designed with a relatively high hydraulic residence time, minimizing the opportunity for disease introduction while also minimizing discharge issues. This paper describes the underlying rationale for an airlift-floating bead filter combination that is

compatible with the emerging needs of the marine hatchery systems.

**Water quality targets.** Malone and Pfeiffer (2006) proposed a recirculation system classification, laying a foundation for the establishment of systematic engineering criteria for treatment of recirculating systems (Figure 1). They identified 17 distinct recirculating classifications based on salinity, temperature, and trophic level. This paper specifically addresses the treatment of marine systems suitable for use as broodstock maturation and fingerling growout systems in marine hatcheries. Table 1 presents selected water parameters, the levels of which characterize water quality expectations for these hatchery systems. Establishment of these water quality expectations allows the formulation of treatment packages that will meet the operator's performance expectations. The vast majority of marine production needs can be met within the guidelines for oligotrophic and mesotrophic systems; however, there is some encroachment on the eutrophic categories.



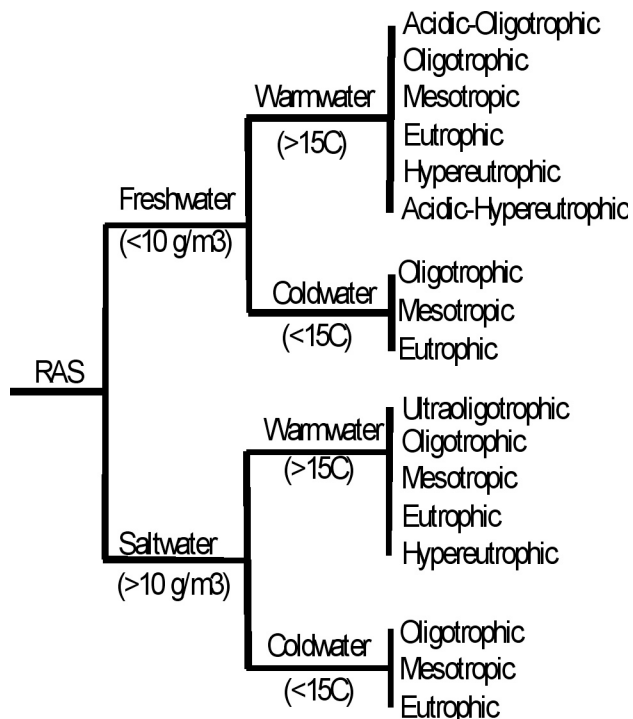

**Figure 1.** Malone and Pfeiffer (2005) identified 17 distinct types of recirculating systems.

**Table 1.** Presumed water quality targets for warm water and cold water marine hatchery systems.

Parameter	Broodstock	Fingerling	Growout	Comment
Total Ammonia-N (mg-N/L)	<0.3	<0.5	<2.0	pH dependent toxicity
Nitrite-N (mg-N/L)	<0.3	<0.5	<2.0	Toxicity most often occurs after loading transitions
Nitrate-N (mg-N/L)	<50	<100	<200	Accumulates as water reuse is extended; toxicity variable
Total Suspended Solids (mg/L)	<5	<15	<25	Contributes to biofouling of biofilters
Biochemical Oxygen Demand (mg-O <sub>2</sub> /L)	<5	<10	<20	Contributes to heterotrophic bacteria growth in biofilters inhibiting nitrification
pH	>7.0	>7.0	>7.0	Low pH inhibits nitrification
Alkalinity (mg-CaCO <sub>3</sub> /L)	>100	>100	>100	Low alkalinity inhibits nitrification
Carbon dioxide (mg/l)	<1	<5	<10	High CO <sub>2</sub> lowers pH

Marine broodstock maturation systems are generally designed to meet the highest water quality expectations. These high standards reflect the high value of the eggs produced by generally fecund broodstock. Egg quality often reflects the health and vigor of the broodstock.

Conditioning of broodstock often takes months and few operations can risk loss of the time and monetary investment associated with death of breeders late in the process. Thus filtration systems are typically oversized, assuring excellent water quality. Maximum thresholds for toxic compounds (total ammonia nitrogen [TAN] and nitrite-N) are set at relatively low levels (<0.3 mg-N/L), while secondary parameters (biochemical oxygen demand [BOD] and total suspended solids [TSS]) are set at levels reflective of natural unpolluted marine systems. Broodstock are generally stocked at a low density (<15 kg/m<sup>3</sup>), a practice that, in combination with the low TAN targets, mandates high recirculation rates.

Fingerling production systems focus on the production of healthy fingerlings sized for release or growout. The value of these fingerlings remains high when measured on an individual weight basis and thus justifies recirculating aquaculture systems (RAS) investment. Fingerlings are generally recognized as sensitive to water quality, so toxic water quality parameters are set at safe but manageable levels (<0.5 mg-N/L). Density of these systems is generally moderate (<30 kg/m<sup>3</sup>), but feeding rates can be high (3–7%/day). Water treatment components must be robust and capable of mitigating high rates of waste production. Suspended solids removal becomes critical at this stage. Solids in recirculating systems are largely organic. Uncontrolled TSS buildups induce bacterial shifts in the biofilters to the detriment of nitrifiers (Ohashi et al. 1996, Ling and Chen 2005).

Many marine fingerling production systems approach densities and fingerling sizes that are more typically associated with freshwater growout. Peak TAN and nitrite levels are allowed to creep upwards (<2.0 mg N/L), a strategy that benefits from pH depression associated with rising carbon dioxide levels and the protective nature of chlorides on nitrite toxicity. Density is allowed to rise to 60 kg/m<sup>3</sup> while the higher TAN targets lessen the importance of recirculation rates. For an example of a recirculating system, see Figure 2. Carbon dioxide removal becomes critical under these growout conditions. Rapid alkalinity consumption in combination with elevated carbon dioxide can induce pH declines that incapacitate nitrifying bacteria.

### Current Treatment Strategies

Floating bead filters utilize a packed bed of floating plastic beads. They display the inherent ability to capture solids across a wide size spectrum.



**Figure 2. Example of a recirculating water treatment system.**

Removal efficiencies decline from nearly 100% in the 30–50  $\mu\text{m}$  size range, but removal in the problematic 5–10  $\mu\text{m}$  slot is high enough to assure removal with multiple passes. Thus floating bead filters are able to provide for both fine and coarse solids removal irrespective of the degree of water reuse. In addition, floating bead filters are designed to encourage biofilm development and naturally provide biofiltration while they are capturing solids. Use of the floating bead filters as bioclarifiers inherently simplifies treatment trains without sacrificing water quality, laying a foundation for simplification.

Malone and Beecher (2000) presented design criteria for warm water systems that have been widely applied to both freshwater and marine systems over the last decade. Their criteria support the application of pumped (circulation) floating bead filters (clarification and biofiltration) with blown air (aeration and carbon dioxide stripping) to the categories of broodstock, fingerlings, and growout systems. This approach has been applied with many variations to fingerling and growout systems.

Some engineers, however, reject the concept of bioclarification and take the traditional approach of complementing the bead filter with a large biofilter. For example, a pumped (circulation) floating bead filter (clarification) with a fine sand fluidized bed (biofiltration) is a common combination. The addition of pure oxygen input through a Speece cone (aeration) and a packed column (carbon dioxide stripping) completes the treatment train for many facilities in the shrimp and ornamental fish industry. A more recent variant utilizes a moving bed reactor for biofiltration. In the freshwater arena a parallel set of designs are distinguished by the use of

microscreens for solids capture instead of a bead filter. Microscreens are often seen in combination with fluidized sand or moving bed reactors. These units are generally complemented by pure oxygen injection through a low head aerator or Speece cone with packed column carbon dioxide stripping (Summerfelt and Sharrer 2004).

The unique demands of marine hatcheries are stimulating the subtle shifts in system designs (Table 2). Central is the demand of pristine waters, a clear shift towards the oligotrophic compared to the demands for high carrying capacity emphasized in the freshwater sector. Additionally, the heating and cooling needs of the systems, environmental issues associated with saltwater discharge, and, particularly, biosecurity issues are encouraging more closure of systems. Biosecurity strategies lead to designs that are more isolated and of smaller scale than corresponding freshwater growout systems.

**Table 2. Water treatment configurations must be adjusted to meet the demands of marine hatchery systems.**

Feature	Motivation	Comment
Oligotrophic Quality	Broodstock protection;	High investment in broodstock and fingerlings dictates a conservative approach
Small scale unit	Biosecurity; Thermal cycling	The diverse hatchery requirements coupled with disease issues results in compartmental designs.
More closure	Biosecurity; discharge regulations	Necessitates attention to fine solids and denitrification
Corrosion Resistance	Metal toxicity; component failures	The corrosion of most metals in saltwater is problematic.
Conductivity	Salt water excellent conductor increasing threat of electrocution	High voltage devices should be kept away from tanks in an isolated, dry enclosure.

It is becoming increasingly apparent that biosecurity issues will force a rethinking of commercial marine hatchery configurations. Biosecurity quickly renders liberal flushing of systems with ambient water obsolete. Similarly, centralized water treatment where mixing of waters inherently compounds the risk of catastrophic losses are unlikely to prove biosecure in a commercial environment. Isolation must be a cornerstone of biosecurity strategies seeking to provide protection of valuable broodstock and fingerlings from internal and external disease vectors. Partitioning of large assemblies of tanks is dictated. Use of individual or small clusters of tanks facilitates treatment or, in the worst case, limits losses when treatment is impracticable. Partitioning also facilitates the

manipulation of individual maturation tanks. Modern biosecure hatcheries will consist of a large number of small isolated recirculating systems.

The engineering community must recognize the changing needs of the industry and focus on the development of treatment strategies appropriate for a large number of dispersed systems. To that end, this paper presents a bead filter/airlift combination that is compatible with these marine hatchery objectives. The combination addresses the five fundamental requirements of recirculation (circulation, solids capture, biofiltration, aeration, and carbon dioxide stripping) in two devices. Both devices are essentially passive, allowing the system to be operated for extended periods of time with periodic inspections. Water loss is very minimal, providing a suitable format for a biosecure operation with a very low environmental profile.

**PolyGeysers filters.** PolyGeysers filters (Aquaculture Systems Technologies LLC, New Orleans, Louisiana) (Figure 3) are bubble-washed floating bead filter units. They are designed to operate as a fixed bed with intermittent backwashing. The distinctive difference between these units and earlier bead filter designs is their ability to recycle their own backwash waters. The unit's operation is pneumatic. Backwashing is implemented automatically by a slow air feed without the need for electronic timers. Thus there is no water loss associated with an individual backwash event. Sludge can be removed from the unit every few days after numerous backwashes have occurred. These characteristics make the unit particularly suitable for marine applications.

A PolyGeysers filter has three distinctive internal components: a) the bead bed, b) the charge chamber, and c) the sludge basin. The distinguishing characteristic is the charge chamber. This inverted compartment is designed to capture and hold a large bubble of air. The chamber is equipped with a triggering device that releases the captured air when the charge chamber is filled. Then air bursts through the bead bed, rapidly mixing it as it drops. Dirty wash waters released by the bead bed rush into the charge chamber, filling it as the air escapes. The bead bed reforms at the top as the filter refills and water filtration resumes. This backwash sequence takes 10–15 seconds. The backwash is so fast that there is no need to interrupt the influent pump.

During the next few hours, a slow bleed of air fills the charge chamber for the next backwash event. This filling process is so slow that the backwash

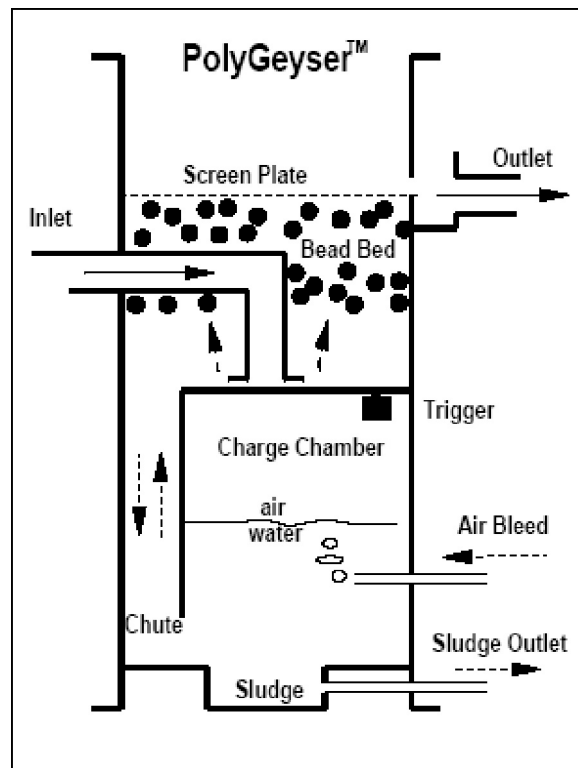

**Figure 3.** The pneumatic charge chamber stores air to wash the beads then acts as a settling basin recycling backwash waters.

waters captured in the charge chamber have time to settle out. A relatively clean stream of water is slowly remixed with the circulating waters as the solids accumulate in the sludge basin. Sludge is removed from the sludge basin usually after a great number of backwash events. Biofilms become abraded when a bead filter is backwashed. The frequency and intensity of backwashing is a major factor that controls the nature of the biofilm, and thus, its biofiltration performance (Golz et al. 1999).

The PolyGeysers filter is normally packed with an enhanced nitrification (EN) media. The EN media was developed to protect nitrifying bacteria during backwashing events (Stahl et al. 2000). It is also more porous than spherical beads. A bed of EN media can hold about twice as much bacteria as a spherical bead bed without displaying excessive head loss.

In the mid-1990s a number of studies confirmed that a frequent but gentle backwashing strategy created conditions optimum for nitrification. Wimberly (1990) found the best performance of his hydraulically washed unit was eight times a day. Sastry et al. (1998) coaxed the best performance out of his bubble-washed units at a backwash frequency of five times a day. Finally, DeLosReyes et al.

(1997) found his unit performed the best with a backwash interval of only two hours. The nitrification performance of filters packed with EN media is comparable to top ranked biofilters such as the moving bed reactor and fluidized sand filters.

The headloss displayed by EN media beds subject to a high frequency washing strategy is very low even when subject to heavy loading. Headloss through the bed itself is typically only a few centimeters. This favorable headloss profile facilitates water circulation with airlift pumps.

**Airlift pumps.** An airlift pump aerates and strips carbon dioxide from the water as it is circulated. Of the five basic processes that form the treatment core of any recirculating system, three of them can be substantially achieved with the simple combination of a piece of PVC pipe and an air blower. The energy input that is normally reserved for the circulating function alone is used to simultaneously effectuate the important gas transfer functions. This strategy can result in extremely simple yet robust system configurations that are very energy efficient in comparison to more traditional pumped configurations.

More subtly, in contrast to centralized water pumps, use of airlift pumps allows the mechanical source of power to be centralized without the corresponding cross contamination issues that occur when waters from different tanks are mixed. This is an important biosecurity distinction for marine hatcheries. A central source of air, usually a low head rotary vane blower, can be located in a dry location away from the corrosive effects of saltwater. The air is distributed pneumatically allowing for precise localized control of the dispersed tank and filter systems without the potential for cross contamination. At the same time, centralized air pumping dramatically reduces upkeep requirements in comparison to multiple near tank centrifugal pumps.

Within the context of recirculating applications, the operational performance of an airlift pump is controlled by the characteristics of the rotary vane blower that drives it. Blowers common to the industry are generally designed for air injection above a depth of 1.5 m, a depth that safely avoids gas bubble disease concerns in most applications. The flow performance of an airlift is defined by the ratio of the lift to the submergence, with flow delivery at a fixed air input increasing dramatically as the lift decreases. Given the constraints on depths of injection, recirculating airlift pumps are most cost

effective when they can be operated at relatively low lifts. Loyless and Malone (1998), for example, presented flow performance curves for a 5.05 cm airlift with a 91.4 cm submergence that showed a 50% decrease in flow delivery as the lift is increased from 7.62 to 30.5 cm.

This issue is further complicated by gas transfer efficiencies. The gas transfer characteristics are controlled by changes in the rate of air injection (gas) as it relates to the water flow (liquid). It is desirable from an energy consumption perspective to operate the airlifts at low gas to liquid ratios (G:L). Air delivery rates are set to meet flow demands only. If additional aeration or degassing capacity is demanded, air is directed to the tank where both oxygen and carbon dioxide are more efficiently transferred (Loyless and Malone 1998).

Gudipati (2005) developed several rules of thumb for the sizing and installation of airlifts for water flow in recirculating applications. This work concluded that airlifts should be designed to operate with submergence to lift ratios in the range of four to five, keeping the G:L below two. The author also observed that lift pipes should be conservatively sized to support a water flow of 0.3 m/sec. Velocity recommendations for approach pipes were higher, in the range of 0.6–0.9 m/sec, representing a balance of scour and headloss concerns. These simple rules facilitate the use of airlifts with a wide variety of low head filtration devices. Figure 4 illustrates an airlift configuration that has been evaluated with PolyGeyser filters ranging in size from 28 L to 1.4 m<sup>3</sup>.

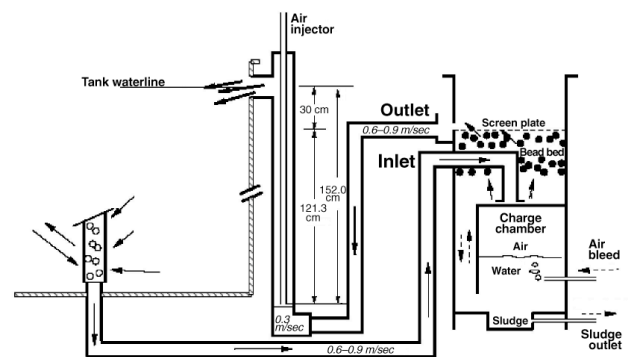

**Figure 4.** Most PolyGeyser filters operate well with a screen placement 30.4 cm and an airlift air injection 122 cm below the tank water level.

The physical positioning of the PolyGeyser filter relative to the water level in the tank is critical. Typically, it is necessary to place the effluent screen

(or pipe) 25–28 cm below the tank water level. This placement assures that there is sufficient water pressure to push the water through the tank screens, through the tank drain lines and up through the bead bed itself under the worst case conditions. Under a variety of applications, the RAS airlifted PolyGeyser tends to operate with a cumulative head loss from tank to filter effluent in the range of 15–38 cm. This low headloss range is compatible with airlifts that have submergence depths in the range of 120–150 cm. Various engineering issues relating to the PolyGeyser filter are presented in Table 3.

**Table 3. Engineering issues to be aware of in a complex airlifted PolyGeyser recirculation system.**

Issue	Problem	Resolution
Leveling	Uncontrolled water level variations along common air distribution lines can undermine controlled air distribution	Level or register all tanks in a common system, firmly affix air injection tubes at common effective water depth
PolyGeyser Flotation	High groundwater or spillage floats PolyGeyser out of ground severing connections	Raise the tank to achieve screen positioning; use French drain to remove rising groundwater
PolyGeyser charge failure	Backpressure on charge chamber bleed lines can exceed airlift pressures, flow to charge chamber stops	Use separate air pump for charging PolyGeysers, Overpressure air distribution lines with valves to assure charge flow.
Airlifts fail to start after backwash	Pressure in air distribution pipe has fallen below peak startup pressure demands of air lift due to air flow shift	Add pressure gauge/alarm to terminal air delivery line to facilitate monitoring; increase pressure in distribution line, undersized distribution lines?
Airlift flow reversal isolates filter	Adjacent airlift overwhelms and causes flow reversal from tank	Increase pressure differential at distribution valves; multiple airlifts should discharge above waterline

**Airlift/PolyGeyser treatment.** Table 4 provides some interim sizing guidelines for RAS airlifted bead filters. The table presents filter feed levels and approximate tank sizes for a wide distribution of PolyGeyser sizes. The feed loading indicated, coupled with reasonable management of the PolyGeyser as a biofilter, should provide water quality conditions that correspond to the water quality levels indicated in Table 1 for the different loading zones. Sizing for the approach pipes and the lift tubes associated with the airlift recirculation are provided. A dual lift tube option is also sized since the use of two tubes facilitates energy conservation during periods of light loading. Finally the air delivery pressure and flow are provided to allow for selection of air pumps.

**Table 4. These interim guidelines can be used as airlifted PolyGeysers are introduced to support recirculating aquaculture systems (metric version).**

Parameter	PolyGeyser size in liters of enhanced nitrification medium						
	28	57	85	170	283	709	1417
Flow (lpm)	39	155	349	1,395	3,875	24,219	96,875
Broodstock Applications (TAN<0.3 mg-N/L) (Backwashing every 2 days)							
Feed rate dry (kg/d)	0.15	0.3	0.45	0.9	1.5	3.8	7.5
Feedrate fresh (kg/d)	0.5	0.9	1.4	2.7	4.5	11.4	22.7
Tank Volume (m <sup>3</sup> )	1	2	3	6	10	25	50
Fingerling Applications (TAN<0.5 mg-N/L) (Backwashing 1-2 per day)							
Feed rate dry (lb/d)	0.3	0.7	1.0	2.0	3.4	8.5	17.0
Tank Volume (gal)	1	2	3	7	11	28	57
Growout Applications (TAN<1.5 mg-N/L) (Backwashing 2-12 per day)							
Feed rate dry (lb/d)	0.7	1.4	2.0	4.1	6.8	17.0	34.1
Tank Volume (gal)	1	2	3	7	11	28	57
Tank air (lpm @ 1.52 m)	85	170	340	680	850	2,610	4,250
Airlift Values							
Tank Drain line (cm)*	3.2	5.1	5.1 or 6.4	7.6	10.2	15.2	25.4
Single Airlift (cm) *	5.1	5.1 or 6.4	7.6	10.2 or 12.7	15.2	25.40	30.5
Dual Airlift (cm)*	N/A	5.1	6.4	7.6	10.2	20.3	25.4
Air (lpm @ 1.52 m)**	3	6	9	18	30	75	150

\* Schedule 40 Pipe Dimensions, 1 ft/sec for airlift pipe, 2-3 ft/sec for drain and approach pipes. Can use one large airlift or 2 smaller.  
\*\* Submergence of a 20 percent submergence with PolyGeyser effluent screen 12 inches below tank water line; G/L supply=2.  
Notes: Check with manufacturers for updates. Based upon need for biofiltration and represent design values with reserve capacity. Applicable to temperature range of 15-30°C

These criteria are applicable for a temperature range of 15–30°C. Application of these criteria under peak loading outside that range should be undertaken with caution. Below a temperature of about 10°C, the overall nitrification capacity of the bioclarifier can be expected to decline. At these low temperatures, systems failure will most probably be indicated by chronic nitrite accumulation. Failure at temperatures above 30°C are most likely to be first evidenced by low dissolved oxygen levels in the rearing tank as decreasing oxygen saturation levels undermine the aeration capacity of the airlifts. Supplemental, in-tank aeration may be appropriate at this point.

Individuals installing larger units should seek professional assistance at the design and installation levels to assure that the elevations for tank and filter are properly selected and that secondary problems such as filter flotation under high groundwater conditions are avoided (Table 4). The air delivery requirements of an individual unit are straightforward. However, facilities that use multiple airlift units should seek professional advice to assure air delivery systems are properly designed. Unexpected changes in air delivery pattern can occur as multiple units randomly backwash. Air distribution systems must be rationally laid out to

assure that air distribution remains predictable. Multiple airlifts serving a single PolyGeysers unit should return discharge water just above the tank waterline to avoid flow reversal between competing airlifts.

There are a number of secondary processes that can be used to complement the PolyGeysers/airlift combination that form the core of the treatment sequence (Table 5). For example, it is common practice to equip broodstock conditioning tanks with an ultraviolet light to suppress expression of marine infectious diseases or parasites.

**Table 5. The PolyGeysers/airlift treatment core can be enhanced by the addition of compatible technologies.**

Device/Process	Function	Comment
Rotating Biological Contactor	Supplemental biofiltration	Air driven models compatible with airlift have been demonstrated
Moving Bed Reactor	Supplemental biofiltration	Compatible with low head operation; contributes to aeration and carbon dioxide stripping
Ultraviolet Lights	Disinfection	Commonly used in broodstock systems
Foam Fractionation (Protein Skimmer)	Controls foaming; contributes to water clarity	Use whenever visible foam persists; appropriate for most fingerling systems
Pure Oxygen Injection	Supplemental aeration	Can be used to extend capacity of fingerling systems; useful in broodstock systems during high activity spawning
Ozonation	Color control	Improve water appearance and enhances biofilter performance
Denitrification	Nitrate & Alkalinity Control	Required for fingerling systems that are operated with extended hydraulic retention times
Heating/Cooling	Temperature Manipulation	Commonly included to assist in maturation of broodstock; heating used to accelerate growth of fingerlings

Addition of a temperature control loop facilitates temperature manipulations used for condition in broodstock. Moving bed reactors and rotating biological filters are examples of two biological filters that can be used in an airlift recirculating system. A number of foam fractionator designs are air driven and compatible with the pneumatic operation of the airlifted PolyGeysers. Foam fractionators are most frequently installed on heavily loaded fingerling systems, or on broodstock systems that are operated with high hydraulic residence times (>5 days). Denitrification also becomes necessary when water reuse extends hydraulic residence times.

## Summary and Conclusions

The special needs of marine hatchery systems are forcing engineers to reevaluate design strategies. Although current design configurations are serving the industry well, increasing biosecurity concerns dictate greater isolation and encourage high reuse designs that minimize exposure to external disease vectors. Internally, marine hatcheries benefit from the decentralization of treatment, a strategy that reduces the potential for internal disease propagation.

The ability of the PolyGeysers floating bead filter to recycle its own backwash waters facilitates the operation of recirculating systems with high hydraulic retention times. This feature also permits the implementation of a high frequency backwashing strategy that avoids headloss buildups in the bead bed. The low headlosses associated with PolyGeysers bioclarifier operation permit airlift circulation. Airlifts provide substantial aeration and degassing as they circulate, laying the foundation for a simplified treatment. An airlift PolyGeysers combination operates completely pneumatically with no moving parts. Operation is robust and requires minimal supervision, desirable features in hatchery operations with multiple isolated tank modules. Recently developed airlift sizing and established beadfilter guidelines have been merged to define interim design guidelines for airlifted PolyGeysers filters. These guidelines will be refined as commercial introductions of the airlifted PolyGeysers continue.

## Acknowledgments

The authors acknowledge the contributions made by commercial and other research and development units toward the refinement of this strategy. Funding for baseline studies was derived in past years from the Louisiana and national Sea Grant College programs. Commercial development was fostered by a Department of Commerce grant and several U.S. Department of Agriculture Small Business Innovative Research Grants conducted by Aquaculture Systems Technologies Inc., New Orleans, Louisiana, under the direction of Douglas Drennan. Burt Nichols at Water Garden Gems Inc., Marion, Texas, has been active through donations of equipment for commercial demonstrations.

An early commercial demonstration (circa 1995) of the airlift technology with a paddle-washer was conducted by Steve Abernathy of Tiltech Inc., Robert, Louisiana. That demonstration, which continues today, formed the driving force for the continued research efforts. Waddell Mariculture Center in South Carolina formed an early test base

for small-scale airlift evaluations, as did the Centro de Investigacion Cientifica y de Educacion Superior de Ensenada (CICESE) in Baja, Mexico. Hubbs-Sea World Research Institute in San Diego, California, has an ongoing evaluation of a 25 cubic foot airlift unit.

Most notably, Mote Aquaculture Park, Sarasota, Florida, is conducting the largest demonstration project consisting currently of four 1.5 m<sup>3</sup> (50 ft<sup>3</sup>) PolyGeyser units on freshwater sturgeon, while evaluating several PolyGeyser Moving Bed combinations on their marine broodstock systems. These pioneers identified the limitations of our knowledge as this emerging technology was introduced.

## References

- DeLosReyes Jr., A. A., L. E. Beecher, and R.F. Malone. 1997. Design rationale for an air-driven recirculating system employing a bubble-washed bead filter. *In* M. B. Timmons and T. Losordo (eds.), *Advances in aquacultural engineering: Aquacultural Engineering Society Proceedings III, ISTA IV, Orlando, FL, 9–12 November 1997*, p. 287–294. NRAES, New York.
- Golz, W. J., K. A. Rusch, and R. F. Malone. 1999. Modeling the major limitations on nitrification in floating-bead filters. *Aquacult. Eng.* 20:43–61.
- Gudipati, S. 2005. Distributed airlift systems design with application to recirculating soft shell crawfish shedding systems. Master's thesis. Louisiana State University, Baton Rouge.
- Ling, J., and S. Chen. 2005. Impact of organic carbon on nitrification performance of different biofilters. *Aquacult. Eng.* 33:150–62.
- Loyless, J. C., and R. F. Malone. 1998. Evaluation of airlift pump capabilities for water delivery, aeration, and degasification for application to recirculating aquaculture systems. *Aquacult. Eng.* 18:117–133.
- Malone, R. F., and L. E. Beecher. 2000. Use of floating bead filters to recondition recirculating waters in warmwater aquaculture production systems. *Aquacult. Eng.* 22:57–73.
- Malone, R. F. 2002. Engineering for a responsible aquaculture with focus on growout facilities for commodity foodfish. *In* R. L. Creswell and R. Flos (eds.), *Perspectives on responsible aquaculture for the new millennium*, p. 94–111. World Aquaculture Society, Baton Rouge, Louisiana, and European Aquaculture Society, Oostende, Belgium.
- Malone, R. F., and T. J. Pfeiffer. 2006. Design and selection of biological filters for freshwater and marine applications. *Aquacult. Eng.* 34(3):389-402.
- Ohashi, A., D. G. Viraj de Silva, B. Mobarry, J. A. Manem, D. A. Stahl, and B. E. Rittmann. 1996. Influence of substrate C/N ratio on the structure of multi-species biofilms consisting of nitrifiers and heterotrophs. *Water Sci. Technol.* 32(8):75–84.
- Sastry, B. N., A. A. DeLosReyes Jr., K. A. Rusch, and R. F. Malone. 1999. Nitrification performance of a bubble-washed bead filter for combined solids removal and biological filtration in a recirculating aquaculture system. *Aquacult. Eng.* 19:105–117.
- Summerfelt, S. T., and M. Sharrer. 2004. Design implication of carbon dioxide production within biofilters contained in recirculating salmonid culture systems. *Aquacult. Eng.* 32:171–182.
- Wimberly, D. M. 1990. Development and evaluation of a low-density media biofiltration unit for use in recirculating fish culture systems. Master's thesis. Louisiana State University, Baton Rouge.

# Preparation of Marine Silage and its Potential for Industrial Use

Motoharu Uchida

National Research Institute of Fisheries and Environment of Inland Sea

2-17-5 Ohno, Hatsukaichi

Hiroshima, Japan 739-0452

uchida@affrc.go.jp

**Keywords:** hatchery diet, lactic acid fermentation, marine silage, seaweed

## Abstract

Marine silage (MS) as used here is a dietary material prepared from algae by a fermentation process. The objective of this paper is to report on the method used to prepare MS from seaweeds and discuss its potential for industrial use. The fermentation of seaweeds can be performed by the enzymatic saccharification by cellulase, followed by fermentation using lactic acid bacteria and/or yeast. The method can be applied to any kind of seaweed containing cellulose. Red sea bream that were challenged with iridovirus and fed a diet containing MS at 10% (w/w) of the diet showed a significantly improved survival percentage compared with those fed a control diet. The use of MS in the diet may allow for the production of cultured fish that are free of drugs.

In the case of Asian kelp (*Undaria pinnatifida*), the fronds are fragile and easily decomposed during the saccharification process. The particle size of the product obtained (single cell detritus-marine silage, or SCD-MS) is ca. 5~10  $\mu\text{m}$  in diameter, similar to a microalgae diet. The mass culture of the SCD-MS can be performed in a plastic tank, with concentrations reaching ca.  $10^7$ – $10^8$  cells/mL. Supplemental aeration, temperature control, and light control are not necessary.

Feeding trials with pearl oyster (*Pinctada fucata martensii*) spat demonstrated the dietary value of the SCD-MS to bivalves. The SCD-MS diet may replace a part of microalgae diets in the future. The development of the SCD-MS diet also suggests a new style of aquaculture. We are attempting to link the production of nuisance algae such as *Ulva* spp. to fish production utilizing the marine silage system. We believe that aquaculture based on algal fermented materials is ecofriendly.

## Introduction

Fermentation has a long history and plays an important role in agriculture and the livestock industry for preparing compost and silage. However, fermentation is not extensively used to feed fish except for some limited applications in ingredient manufacturing. Particularly lacking has been the approach of fermenting algae, which are plentiful in marine ecosystems. In fact, there have been no fermented food products made from marine algae (Figure 1). Recently, the author developed a method to perform lactic acid fermentation on seaweeds (Uchida and Murata 2002). The method contains two elements (Figure 2a). The first is the enzymatic decomposition and saccharification of seaweeds. The second is lactic acid fermentation using microorganisms. These two processes can be performed simultaneously by adding polysaccharide-decomposing enzymes; usually cellulase, and starter microorganisms; usually lactic acid bacteria (LAB) or yeast to initiate the process. This method can be

applied to any type of seaweed that contains cellulose (Table 1, Uchida and Murata 2004).

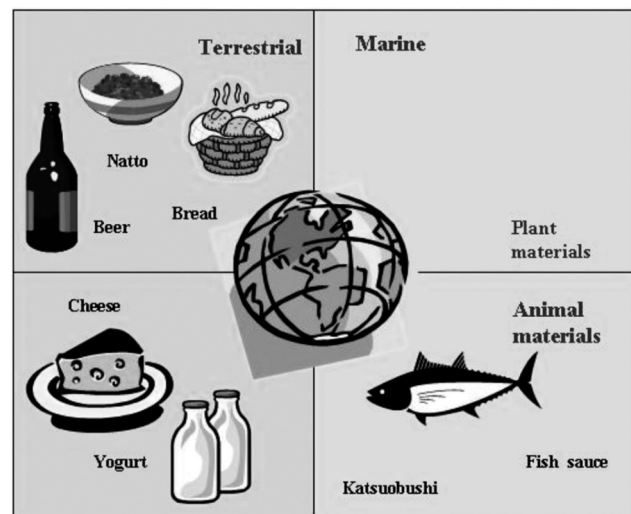

Figure 1. Categories of fermented food products.

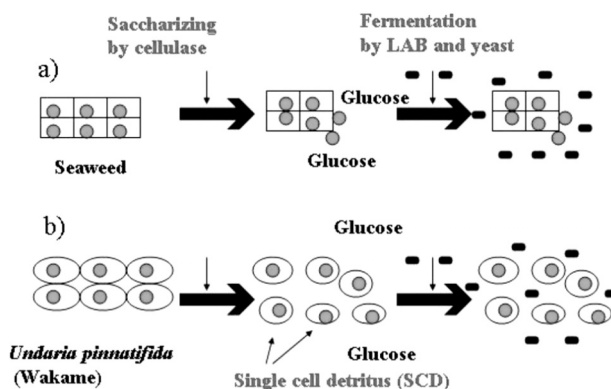

**Table 1. Results of the fermentation test for various kinds of seaweed with the addition of cellulase and the microbial starter mixture (Uchida and Murata 2002).**

Seaweeds*	Group	pH after 7Ds	Products (g/100mL)	
			Lactic acid	Ethanol
<i>Chondracanthus tenellus</i>		3.9	+(0.25)	+(0.18)
<i>Gracilaria vermiculophylla</i>		4.0	+(0.31)	+(0.23)
<i>Hypnea charoides</i>		6.1	+(0.22)	+(0.16)
<i>Chondracanthus teedii</i>		4.5	+(0.16)	+(0.18)
<i>Pterocladiaella capillacea</i>	Rhodophyta	5.6	+(0.12)	+(0.08)
<i>Prionitis angusta</i>		3.8	+(0.25)	+(0.17)
<i>Prionitis divaricata</i>		4.7	+(0.25)	+(0.41)
<i>Gelidium linoides</i>		5.3	+(0.18)	+(0.12)
<i>Gracilaria incurvata</i> -like		4.0	+(0.25)	+(0.12)
<i>Padina arborescens</i>		5.8	-(<0.01)	+(0.08)
<i>Sargassum ringgoldianum</i>		5.0	±(0.01)	+(0.04)
<i>Hizikia fusiformis</i>		5.0	±(0.01)	+(0.24)
<i>Ishige okamurae</i>		4.9	±(0.01)	+(0.10)
<i>Dilophus okamurae</i>		6.1	±(0.02)	+(0.04)
<i>Eisenia bicyclis</i>	Chromophyta	4.2	±(0.02)	+(0.03)
<i>Undaria pinnatifida</i> (Air-dried)		3.6	+(0.23)	+(0.38)
<i>Undaria pinnatifida</i> (Whole)		3.9	+(0.18)	+(0.07)
<i>Undaria pinnatifida</i> (Stem)		3.5	+(0.25)	+(0.12)
<i>Laminaria japonica</i> (Damp-dried)		3.3	+(0.16)	+(0.15)
<i>Ulva</i> sp. (Harvested at Yokohama)	Chlorophyta	3.3	+(0.76)	+(0.16)
<i>Ulva</i> sp. (Harvested at Yokosuka)		4.7	+(0.45)	+(0.41)
<i>Zostera marina</i>	Calyciferiidae	3.3	+(1.14)	+(0.26)

The author is promoting the use of this fermented material from seaweed as a fish dietary ingredient with the proposed name marine silage (MS). Furthermore, in the case of Asian kelp (*Undaria pinnatifida*), the observation was made that the frond tissue can be decomposed to one-cell units by cellulase during fermentation (Figure 2b). As a result, large numbers of small detrital particles (ca. 5–10 µm in diameter) are produced. The author termed these particles single cell detritus-marine silage (SCD-MS) and studied the optimal culture conditions for preparing the material (Uchida and Murata 2002).

This paper reports on the suitable culture conditions for performing lactic acid fermentation of seaweed and for preparing SCD-MS with high efficiency. Furthermore, to demonstrate the potential of the MS as fish dietary ingredient, a feeding trial was conducted with red sea bream. Since the size of the SCD-MS is analogous to microalgae diets such as *Chaetoceros calcitrans* and *Pavlova lutheri*, a feeding trial with young pearl oysters (*Pinctada fucata martensii*) was also conducted to demonstrate the dietary value of the SCD-MS as a replacement for microalgae diets (Uchida et al. 2004a).



**Figure 2. Fermentation process of seaweed. Lactic acid fermentation (a) and lactic acid fermentation with single cell detritus (SCD-MS) products (b).**

## Materials and Methods

### Preparation of SCD-MS for determining appropriate culture conditions.

To determine the appropriate culture conditions for SCD-MS, sterile 500 mL polycarbonate bottles with screw caps (Nalgene) were used for a small scale fermentation trial. A commercial product of dried particles of *U. pinnatifida* (Wakamidori <74 µm, Riken Co.) was dispensed in the amount of 10.0 g each into bottles containing 180 mL of autoclaved 3.5% w/v NaCl solution and cellulase (R-10, Yakult Pharmaceutical Ind. Co.) (Table 1) and mixed well. The culture bottles were capped and incubated at 20°C with shaking several times a day to improve dispersion. Initially, the preparation of SCD in cultures without the addition of a microbial mixture was conducted under various reaction temperatures and cellulase concentrations. The number of detrital particles of *Undaria* obtained was counted using a Coulter Multisizer (Coulter Electronics Ltd.) with a 140 µm orifice. The detrital particles in the fractions of 5.8–11.5 µm in diameter were tentatively regarded as SCD-MS products. The weight distribution was calculated from the distribution of the detrital particles on the assumption that the detrital particles were of a spherical form with a specific gravity of 1.0.

For testing the effect of the use of microbial elements as a starter, cultures containing different levels of cellulase were incubated with an inoculation of the microbial mixture. The microbial mixture was composed of one type of LAB *Lactobacillus brevis* strain B5201 (FRA 000033) and two types of yeast: *Debaryomyces hansenii* strain Y5201 (FERM BP-7302) and *Candida* sp. strain Y5206 (FERM BP-7303). The bacterium and yeast cells were

preincubated in MRS broth (Merck) and YM broth (Difco), respectively, collected by centrifuge, washed twice, and suspended in sterile 0.85% NaCl solution at a concentration of OD 660 nm = 1.0. The suspension mixture of 2 mL of *L. brevis* (containing  $1.0 \times 10^9$  cells) and 1 mL each of *D. hansenii* ( $5.3 \times 10^5$  cells) and *Candida* sp. ( $1.2 \times 10^7$  cells) was used for inoculation of the microbial mixture. All cultures were prepared in duplicate and the average values of data were determined.

**Mini preparation of SCD-MS.** A sterile 50 mL volume polypropylene centrifuge tube provided with a screw cap (Iwaki) was used to prepare the fermentation cultures. To prepare NaCl-added cultures (No. 1a–14a), 2.0 g of the *Undaria* product were mixed with 40 mL of autoclaved 3.5% NaCl solution, 40 mg of cellulase 12S (Yakult Pharmaceutical), and 0.4 mL of bacterial cell suspension and mixed. The bacterial cell suspension was prepared for the 14 LAB strains: *L. brevis* FRA 000033, *L. brevis* IAM 12005, *L. plantarum* ATCC 14917<sup>T</sup>, *L. plantarum* IAM 12477<sup>T</sup>, *L. casei* IFO 15883<sup>T</sup>, *L. casei* FRA 000035, *L. rhamnosus* IAM 1118<sup>T</sup>, *L. zae* IAM 12473<sup>T</sup>, *L. acidophilus* IFO 13951<sup>T</sup>, *L. kefir* NRIC 1693<sup>T</sup>, *L. fermentum* ATCC 14931<sup>T</sup>, *L. delbrueckii bulgaricus* ATCC 11842<sup>T</sup>, *Streptococcus thermophilus* NCFB 2392, and *Leuconostoc mesenteroides* IAM 13004<sup>T</sup>. The strains were precultured with MRS medium, collected by centrifuge, resuspended to make a concentration of OD 660 nm = 1.0 (containing  $7.3 \times 10^7$ – $1.1 \times 10^9$  CFU/mL), and used. To prepare non-NaCl cultures (No. 1b–14b), autoclaved distilled water was used instead of 3.5% NaCl solution. Cultures without LAB inoculation were prepared as No LAB controls (No. 15a and 15b). The triplicate cultures were incubated at 20°C for 11 days mixing several times by hands every day to help dispersion.

**Mass preparation of SCD-MS.** Sterile 10 L polycarbonate bottles with screw caps (Nalgene) were used for the preparation of MS. One kg of *U. pinnatifida* Wakamidori was dispensed into bottles containing 9 L of autoclaved 3.3% NaCl solution and 10 g cellulase R-10 and mixed well. The cultures were inoculated with the microbial mixture at quantity of  $5.0 \times 10^{10}$  CFU (*L. brevis*),  $5.5 \times 10^7$  CFU (*D. hansenii*) and  $1.2 \times 10^8$  CFU (*Candida* sp.). Each culture bottle was capped, incubated at 20°C and mixed several times a day to improve dispersion for the first eight days. The culture bottles were then preserved at 20°C for 18 months.

**Rearing trial for red sea bream challenged with iridovirus.** The *Ecklonia*-MS was prepared by fermenting the *Ecklonia maxima* (a dried product imported from South Africa) at 10°C for one month after the addition of 0.15% (as a final conc.) cellulase 3S (Yakult Pharmaceutical Ind. Co.), 0.035% pectinase G (Amano Enzyme Co.), and  $8 \times 10^6$  CFU/mL *L. plantarum* (TOA Pharmaceuticals Co.). The *Ecklonia*-MS diet was prepared by adding the *Ecklonia*-MS to a control diet at 10% w/w. The composition of the control diet was 40 g brown meal, 20 g white meal, 10 g northern krill meal, 7 g sardine oil, 8 g dextrin, 10 g wheat gluten, 3 g guar gum, 1 g vitamin mixture, 0.1 g mineral mixture, 0.66 g CaCO<sub>3</sub>, 0.23 g CaPO<sub>4</sub>, and 0.01 g Hospitane. For the rearing trial, red sea bream (mean  $\pm$ SD of body weight = 32.9 g  $\pm$ 3.2 g) were challenged with 50  $\mu$ L each of iridovirus stock suspension (TCID<sub>50</sub> =  $10^{5.8}$ /mL). Then 50 individuals were held in each of three 200 L tanks and reared at 25°C. The rearing water was changed at the rate of 1L/min. The fish were fed to satiation twice a day.

**Rearing trial for young Japanese pearl oysters.** For the preparation of MS for the rearing test, 20 g of the *Undaria* product was dispensed into 500 mL polycarbonate bottles containing 360 mL of 3.5% NaCl solution and 2 g cellulase R-10 and mixed well. The cultures were inoculated with 2 mL of the cell suspensions of the previously described three types of microorganisms and incubated for 8 days at 20°C (SCD-MS2). A culture that was prepared without addition of the microorganisms and incubation was used as a control diet (C-MS2). The SCD-MS2 and C-MS2 were preserved at 5°C during the rearing test and filtered through 6.3  $\mu$ m nylon mesh just before use. Early stationary phase cells of *Chaetoceros calcitrans* were prepared by culture at 20°C (14 h:10 h light:dark cycle) in a modified Erd-Schreiber medium. For the rearing trial, 15 young Japanese pearl oysters (mean of hinge length = 4.47–4.95 mm) were held in a 5 L tank and reared for 12 days. The rearing water was supplied with air and kept at a temperature of 27°C and a salinity of 32–33 ppt. Oysters were fed once a day and the rearing water was changed every day with fresh, sand-filtered seawater. The control groups were an unfed group, a *Chaetoceros* group ( $3 \times 10^4$  cells/mL/day), and a 1/10 *Chaetoceros* group ( $3 \times 10^3$  cells/mL/day). The test groups were those fed the SCD-MS at  $2 \times 10^4$  cells/mL/day (SCD-MS2) and  $5 \times 10^4$  cells/mL/day ( $\times 2.5$  SCD-MS2). The combined feeding was tested by feeding the MS2 at  $2 \times 10^4$  cells/mL/day with *Chaetoceros* at  $3 \times 10^3$  cells/mL/day (SCD-MS2 +

1/10 *Chaetoceros*). The test groups using the C-MS2 diet were presented with the same feeding conditions as the SCD-MS2 groups. Shell length of the spat's hinge lines (hinge length) were measured and used for calculating growth rates. The survival rate of the spat was obtained by counting the number of living individuals at the end of the rearing trials.

## Results and Discussion

**Suitable culture conditions for preparing the SCD-MS.** The relationship between the culture temperature and the number of SCD-MS products was studied with a culture containing 3.5% NaCl and 1.0% cellulase. The volume proportion of SCD-MS increased gradually and reached a maximum value in the range of 60.1–69.0% on the fourteenth day (Figure 3). The production efficiency of SCD-MS was maximum at 2°C and almost constant in the range of 20–50°C based on the profile of Figure 3. The production efficiency of SCD-MS was maximum at 2°C and almost constant in the range of 20–50°C based on the profile of Figure 3.

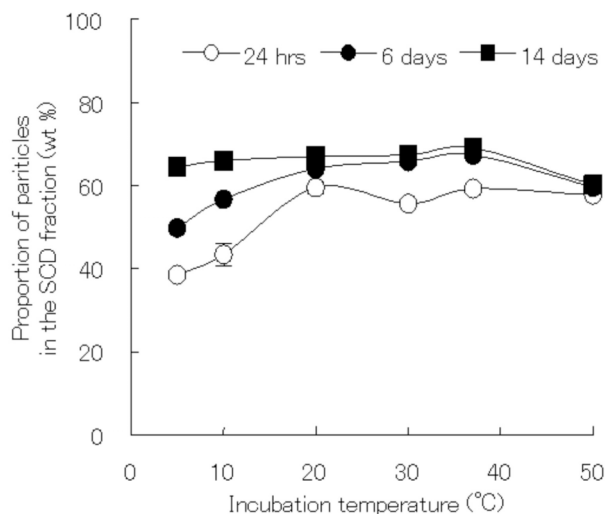
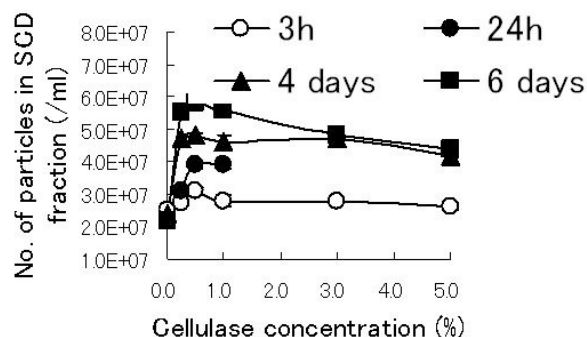

**Figure 3. Relationship between culture temperature and production efficiency of SCD-MS.**

Figure 4 shows a profile of the relationship between cellulase concentration and the number of SCD-MS in *Undaria* cultures prepared in the presence of starter microbes. The number of SCD-MS increased from  $2.5 \times 10^7$ /mL (18.4% based on volume proportion) at the start to  $3.5$ – $5.9 \times 10^7$ /mL (63.0–69.1% based on volume proportion) at 6 days of incubation and the maximum SCD-MS products were obtained with a cellulase concentration at 0.5% (59.1% based on volume proportion). Culture media without the addition of cellulase had unacceptable

odors and were judged to have rotted. In contrast, the culture media containing cellulase at 0.25–5.0% had ester-like preferable odors and were judged to be fermented.

For the cultures without cellulase, microbial flora after 5 days of culture varied greatly, implying unstable culture conditions from the viewpoint of microbial composition. One culture contained predominantly lactic acid bacteria (80.5% of heterotrophic microorganisms) while the other contained predominantly marine heterotrophic microorganisms (92.9%). For the fermented cultures, lactic acid bacteria were predominant at a  $10^8$  CFU/mL level and the ratio of lactic acid bacteria to heterotrophic microorganisms was in the range of 8.5–11%, while the proportions of marine heterotrophic against heterotrophic microorganisms were in the range of 3.6–8.0%. It was observed that the addition of 0.25% cellulase to the culture media was enough to obtain SCD-MS without spoilage if the starter microorganisms were added (Table 2). In contrast, the addition of cellulase more than 0.5% was necessary to obtain SCD-MS without spoilage if the starter microorganisms were not added.



**Figure 4. Relationship between cellulase concentration and production efficiency of SCD-MS.**

**Table 2. Cellulase concentration necessary for successful fermentation.**

Cellulase conc. (% w/v)	0.0	0.01	0.10	0.25	0.5	1.0	3.0	5.0
Without starter mic.	pH 4.9	5.3	5.7	5.8	4.5&3.9	5.6	5.3	-
	F/R	R	R	R	R&F	F	F	-
With starter mic.	pH 4.9	-	4.3	4.2	4.2	4.1	4.1	4.1
	F/R	R	F	F	F	F	F	F

F; fermented, R; rotten

The starter microorganisms were first obtained from a naturally fermented material of *Ulva* spp. Three species of microorganisms, namely *L. brevis*,

*D. hansenii* and *Candida* sp., were isolated as predominant microorganisms in the fermented *Ulva*. We observed that the addition of the individually cultured cell suspensions of these microorganisms as a starter for fermentation of seaweed was effective in the production of SCD-MS (Uchida and Murata 2004). However, we also found that lactic acid bacteria alone can be used as a starter (Uchida et al. 2004b). Results of fermentation with NaCl-added cultures are shown in Figure 5a. The predominance of the inoculated species in the cultures was 100% for the cases of *L. casei* IFO 15883<sup>T</sup> and *L. casei* FRA 000035; 96.7% for the cases of *L. brevis* FRA 000033, *L. brevis* IAM 12005, and *L. plantarum* IAM 12477<sup>T</sup>; 93.3% for the case of *L. plantarum* ATCC 14917<sup>T</sup>; 90.0% for the case of *L. rhamnosus*; 13.3% for the case of *L. fermentum*; and less than 3.3% for the cases of *L. zaeae*, *L. acidophilus*, *L. kefir*, *L. delbrueckii bulgaricus*, *S. thermophilus*, and *Leuconostoc mesenteroides*. The LAB became predominant (>90.0%) for 13 cases out of 14, while the inoculated species became predominant for 7 cases out of 14.

Results of fermentation with NaCl-less cultures are shown in Figure 5b. The predominance of the starter species was 100% for the cases of *L. casei* IFO 15883<sup>T</sup>, *L. casei* FRA 000035, and *L. rhamnosus*; 96.7% for the cases of *L. brevis* FRA 000033 and *L. plantarum* ATCC 14917<sup>T</sup>; 90.0% for the case of *L. plantarum* IAM 12477<sup>T</sup>; 63.0% for the case of *L. brevis* IAM 12005; 3.3–20.0% for the cases of *L. zaeae*, *L. kefir*, *L. fermentum*, and *Leuconostoc Mesenteroides*; and less than 3.3% for the cases of *L. acidophilus*, *L. delbrueckii bulgaricus*, and *Streptococcus Thermophilus*. The LAB became predominant (>90.0%) for 10 cases out of 14, while the inoculated species became predominant for the 6 cases out of 14. *L. brevis*, *L. plantarum*, *L. casei*, and *L. rhamnosus* predominated in the MS cultures.

**Promotion of survival rate of fish against viral disease.** Red sea bream challenged with iridovirus and fed a diet containing the MS showed significantly better survival rate (86.5% ± 1.6%) compared with those fed the control diet (73.1% ± 6.3%). The use of MS diet may help increase the supply of fish that are produced without the use of drugs, which is an important consideration for consumers today.

**SCD-MS as a replacement hatchery diet for microalgae diet.** Since the size of the SCD-MS is about 5–10 μm in diameter, it has a potential to replace microalgal diets in hatcheries. Table 3 shows

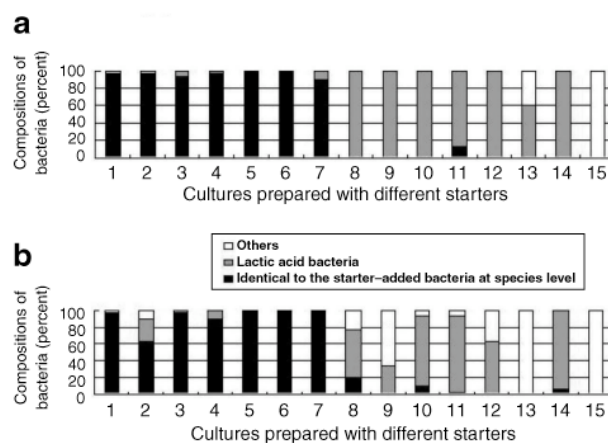

**Figure 5. Microbial compositions after fermentation of *Undaria* with inoculation of different starters in NaCl-added cultures (a) and cultures lacking NaCl (b). Starter strains No. 1–14 are: *L. brevis* FRA 000033, *L. brevis* IAM 12005, *L. plantarum* ATCC 14917<sup>T</sup>, *L. plantarum* IAM 12477<sup>T</sup>, *L. casei* IFO 15883<sup>T</sup>, *L. casei* FRA 000035, *L. rhamnosus* IAM 1118<sup>T</sup>, *L. zaeae* IAM 12473<sup>T</sup>, *L. acidophilus* IFO 13951<sup>T</sup>, *L. kefir* NRIC 1693<sup>T</sup>, *L. fermentum* ATCC 14931<sup>T</sup>, *L. delbrueckii subsp. bulgaricus* ATCC 11842<sup>T</sup>, *Streptococcus thermophilus* NCFB 2392, and *Leuconostoc mesenteroides* IAM 13004<sup>T</sup>. Culture 15a and 15b are control cultures prepared without starter inoculation.**

the results of a feeding trial conducted on young pearl oysters. The feeding of *Chaetoceros calcitrans* at 3 × 10<sup>4</sup> cells/mL/day resulted in a shell growth of 168 μm/day and survival of 66.7%, while unfed controls showed negative shell growth (–10 μm/day) and 53.3% survival. Feeding with a SCD-MS prepared from *U. pinnatifida* at 2 × 10<sup>4</sup> cells/mL/day resulted in a shell growth of 23 μm/day and survival of 53.3%. When the SCD-MS was supplied with *C. calcitrans* at 3 × 10<sup>3</sup> cells/mL/day, shell growth was 130 μm/day and survival was 80%. This study demonstrates the dietary value of SCD-MS to bivalve mollusks and shows that SCD-MS can partially replace microalgal diets in hatcheries.

**Table 3. Results of feeding trials of SCD-MS2 and C-MS2 with young pearl oyster (Uchida et al. 2004a).**

Treatments	Feeding conditions (cells/mL/day)	Growth rate of hinge length (Mean ± SE, μm/day) <sup>a</sup>	Survival (%)
Unfed	No feed	-10 ± 14 <sup>d</sup>	53.3
<i>Chaetoceros</i>	3 × 10 <sup>4</sup>	168 ± 33 <sup>ab</sup>	66.7
1/10 <i>Chaetoceros</i>	3 × 10 <sup>3</sup>	11 ± 10 <sup>d</sup>	66.7
SCD-MS2	2 × 10 <sup>4</sup>	23 ± 13 <sup>c</sup>	53.3
SCD-MS2+1/10 <i>Chaetoceros</i>	2 × 10 <sup>4</sup> (MS2) + 3 × 10 <sup>3</sup> ( <i>C. calcitrans</i> )	125 ± 13 <sup>a</sup>	80.0
x2.5 SCD-MS2	5 × 10 <sup>4</sup>	47 ± 17 <sup>bc</sup>	66.7
C-MS2	2 × 10 <sup>4</sup>	18 ± 16 <sup>c</sup>	66.7
C-MS2+1/10 <i>Chaetoceros</i>	2 × 10 <sup>4</sup> (MS2C) + 3 × 10 <sup>3</sup> ( <i>C. calcitrans</i> )	71 ± 14 <sup>abc</sup>	93.3
x2.5 C-MS2	5 × 10 <sup>4</sup>	23 ± 18 <sup>c</sup>	53.3

Results are based on a single rearing trial (n=15).

<sup>a</sup> Treatments with common superscripts are not significantly different (Games-Howell test, P<0.05)

## New Aquaculture Style Based on Marine Silage

The development of the MS preparation technology and its widespread use may change the way aquatic animals are fed in the future. Figure 6 presents the concept of aquaculture based on a sustainable and ecofriendly marine silage system. There has been an increase in nuisance blooms of *Ulva* spp. and other green algae in the eutrophic coastal waters of many countries. The blooms are believed to be the result of excessive nutrients such as nitrogen and phosphate in coastal waters. Therefore, collection and utilization of algal fronds could contribute to decreases in coastal water nutrient levels. Another likely advantage in the use of SCD-MS diets is that the microorganisms present in the SCD-MS media may have probiotic or prebiotic effects on the animals being reared. We are currently working on that potential for SCD-MS.

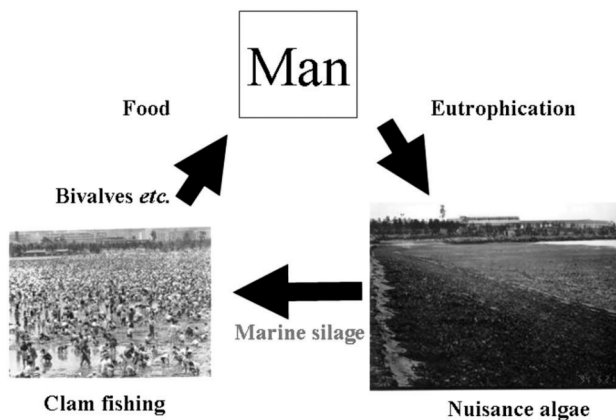

Figure 6. Concept of eco-friendly aquaculture based on a marine silage diet.

## References

- Uchida, M., and M. Murata. 2002. Fermentative preparation of single cell detritus from seaweed, *Undaria pinnatifida*, suitable as a replacement hatchery diet for unicellular algae. *Aquaculture* 207:345–357.
- Uchida, M., and M. Murata. 2004. Isolation of a lactic acid bacterium and yeast consortium from a fermented material of *Ulva* spp. (Chlorophyta). *J. Appl. Microbiol.* 97:1297–1310.
- Uchida, M., K. Numaguchi, and M. Murata. 2004a. Mass preparation of marine silage from *Undaria pinnatifida* and its dietary effect for young pearl oyster. *Fish. Sci.* 70:456–462.
- Uchida, M., H. Amakasu, Y. Satoh, and M. Murata. 2004b. Combinations of lactic acid bacteria and yeast suitable for preparation of marine silage. *Fish. Sci.* 70:508–518.

# Techniques for Live Capture of Deepwater Fishes with Special Emphasis on the Design and Application of a Low-cost Hyperbaric Chamber

Jeffrey E. Smiley and Mark A. Drawbridge  
Hubbs-SeaWorld Research Institute  
2595 Ingraham Street  
San Diego, CA 92109  
JSmiley@hswri.org

**Keywords:** hyperbaric chamber, rockfish, gas bladder

## Abstract

Following rapid depressurization from depth, physoclistous fish suffer from overinflation of their gas bladder. The decreased pressure also causes bubbles to form in the circulatory system and causes trauma to internal tissues resulting in hemorrhage, swelling, and death. Our research has shown that Cowcod (*Sebastes levis*) can only survive a few hours after rapid depressurization from depths as shallow as 90 m. To overcome this problem, we developed a relatively simple, low cost hyperbaric chamber to aid in the collection of adult rockfish to hold as broodstock. This system was designed to quickly recompress fish once brought to the surface on hook and line, and allow for decompression over a period of days. The hyperbaric chamber is capable of continuous stable operation at <10.2 atmospheres and can accommodate fish up to 91.4 cm in length and 26.8 cm in diameter. Pressure in the chamber is maintained by a Goulds booster pump that delivers continuous pressure and supplies flows of 3.8–7.6 L/min to as many as four chambers. The hyperbaric chamber operated very effectively and allowed us to successfully decompress 14 cowcod and two vermilion rockfish (*Sebastes miniatus*) from capture depths of 90.2–146.3 m.

## Introduction

When fish are captured at depth, rapid depressurization can cause serious injuries, including gas bubbles in the blood vessels, gills, skin, and brain; exophthalmia; internal and external hemorrhage; everted stomachs; disoriented swimming; altered behavior; and death (Gotshall 1964, Beyer et al. 1976, Feathers and Knable 1983, Rogers et al. 1986, Gitschlag and Renaud 1994). Specialized collection techniques are needed to minimize barotrauma among deepwater fishes that are collected live for public display or breeding programs. Collection techniques will vary based on the depth of capture and sensitivity of the target species.

Techniques used to collect fish from depth typically include cages, trawls, and hook and line fishing. Without special handling, fish collected using these methods are typically either moribund or dead. Special handling techniques include gradual decompression and gas bladder deflation (Gotshall 1964, Lee 1992, Keniry 1996). Gas bladder deflation has enabled collection of some specimens from the sea, but mortality is highly variable and increases with depth. To increase survivability, more time must be taken to decompress fish. In order to accomplish this, specialized pressure-controlled

chambers have been developed. These hyperbaric chambers are typically designed to trap fish at depth and return them to the surface under pressure (Jannasch et al. 1973, Yayanos 1978, Macdonald and Gilchrist 1978, Wilson and Smith 1985, Koyama et al. 2002).

Hyperbaric fish traps have made it possible to collect specimens from the deep sea (600–5,700 m) but they are very costly to design and build, thereby creating the need for a low cost solution, especially for fish at shallower depths. To meet this need, we developed a portable hyperbaric chamber that is capable of recompressing fish brought to the surface, then maintaining them at pressures up to 10.2 atmospheres for weeks. We targeted several species of rockfish (*Sebastes* sp.) with the goal of holding the fish for breeding purposes.

## Hyperbaric Chamber Design and Construction

**Design criteria.** The hyperbaric chamber described in this paper was designed based on the following criteria:

1. Portability to allow manageable movement of fish from the field to the laboratory under controlled conditions.

2. Low cost using standardized parts that are common and relatively inexpensive.
3. Pressure stabilization at 150 psi to allow complete recompression of fish caught at depths of 102.7 m.
4. Temperature control to maintain constant conditions from the point of capture thereby reducing stress on the fish.
5. Visual monitoring to ascertain fish health and make decisions for safe decompression schedules.
6. Water quality monitoring to ensure stable seawater temperature and adequate dissolved oxygen concentrations.

Designing the rest of the apparatus to meet our portability goals required a multipart decompression system that could be broken apart in manageable sections. These sections included a primary and secondary manifold and chamber. The primary manifold was responsible for maintaining stable pressures for the secondary manifolds, the secondary manifolds were responsible for maintaining stable pressures and flows in the chambers, and the chambers were responsible for specimen containment and pressure isolation for greater than 30 minutes; the time allowed for transport from the boat back to the lab.

**Principle component: Primary manifold.** Pressure in the primary manifold was created by a 3.0 hp Goulds booster pump (25GBS3014P4) that delivered 94.6 L/min of seawater to the apparatus. Pressure in the system was controlled by a 2.54 cm pressure relief valve that vented excess seawater back to the sump and created stable backpressure in the system. A portion of the backpressured seawater was diverted before the pressure relief valve and served as the source for the secondary manifolds. Four 1.9 cm ball valves operating in parallel from the primary manifold controlled the flow of seawater to four secondary manifolds through sections of 1.3 cm flexible hose. The hose had a maximum operating pressure of 20.4 atmospheres and ranged in length from 4.6 to 6.1 m. Pressure in the primary manifold was monitored on a 10.1 cm face gauge up to 13.6 atmospheres. Two 5.1 cm ball valves were also installed on the primary manifold and opened during startup procedures to reduce initial water-hammering. For portability the primary manifold and pump was bolted to a hand truck (Figure 1).

**Principle component: Secondary manifold.** A secondary manifold was constructed for each of the

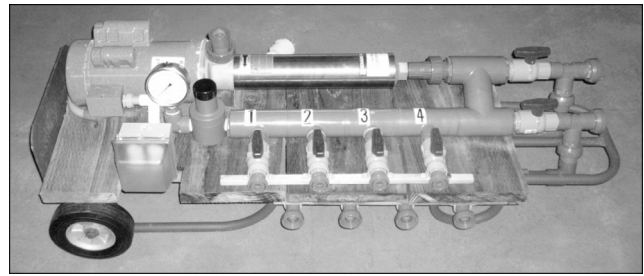

**Figure 1. Portable primary manifold and booster pump attached to a hand truck for ease of transport.**

four chambers that allowed individual pressure and flow control, safety, and bypass loops. Water from the primary manifold was diverted through a check valve and a needle valve designed to control the amount of water delivered to the chamber. Water could enter or bypass the chamber through a 1.9 cm ball valve. This bypass allowed operation of the secondary manifold without seawater flowing through the chamber. After seawater was routed through the chamber or bypass, it was pushed through a t-strainer before being routed through a 0.6 cm pressure relief valve. Downstream of the pressure relief valve, a 1.0 cm normally closed solenoid valve was installed that operated as a safety valve when system power failed. Seawater that had passed the solenoid valve was routed through a rotary flow indicator and two 0.6 cm labcock valves used to divert outgoing flow to a cylindrical reservoir where water quality measurements could be taken. Two other 1.3 cm ball valves were also used to bypass the solenoid and pressure relief valves in the event of component failure or operation at ambient pressure (Figure 2).

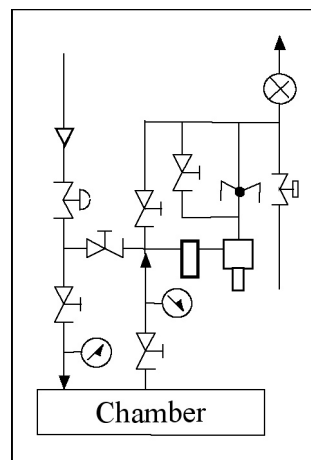

**Figure 2. Schematic of secondary manifold and chamber control valves.**

**Principle component: Chamber.** The hyperbaric chamber was constructed from 30.5 cm schedule 80 PVC pipe with an internal diameter of 28.6 cm. It was cut 91.4 cm in length and had two 30.5 cm flanges glued to each end, increasing internal length to 95.3 cm. On one end a 5.1 cm-thick acrylic window and gasket were bolted to the flange with 12 stainless steel bolts. Two 1.3 cm bulkhead fittings were installed in the side of the cylinder 50.8 cm apart. A 1.3 cm ball valve was connected to each of the bulkhead fitting with two 5.1 cm face pressure gauges located on opposite sides of the valves coming in and out of the chamber. A wood cradle was designed for the chamber allowing it to be strapped to a 600 lb capacity hand truck (Figure 3). The secondary manifold was strapped beneath the chamber. Connections from the chamber to the secondary manifold were made with a 1.3 cm flexible hose rated at 20.4 atmospheres. A PVC blind flange and gasket were attached to the open end of the cylinder to complete the chamber. Pressure in the secondary manifold and chambers reached a maximum of 9.5 atmospheres.

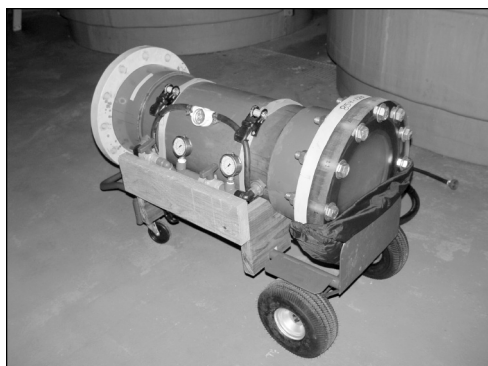

Figure 3. Hyperbaric chamber and secondary manifold (not in view) attached to a hand truck for ease of operation and portability.

### Hyperbaric Apparatus Operation

**Seawater supply.** Seawater supply to the apparatus depended on its location—either in the field or the laboratory. During field operation, the primary manifold was supplied with chilled water from the bait well onboard the vessel using a 0.5 hp Flotec submersible sump pump. In the laboratory, seawater was pumped from Mission Bay (San Diego, California), filtered using rapid sand filters, and chilled in a recirculating sump. The temperature regulation systems at both locations were computer controlled, resulting in consistent supply temperatures.

**Pressurization sequence.** Prior to receiving a fish, each chamber was set on its end (open side up) and filled with seawater (Figure 4). Water pressure was regulated and stabilized in the primary manifold at 10.9 atmospheres and in the chamber bypass line of the secondary manifold at 8.8 atmospheres. Once a fish was caught and brought to the surface, it was placed inside the chamber head down. A blind flange and gasket assembly was then attached to the top of the chamber with 12 stainless steel bolts. The bolts were torqued in a star pattern to 13.1 m/kg. Once sealed, the valves isolating the chamber were opened, which equalized pressure from the secondary manifold. This began the recompression sequence. Once at the maximum pressure, the valve bypassing the chamber on the secondary manifold was closed forcing seawater to flow through the chamber.



Figure 4. Hyperbaric chamber set on end prior to fish insertion.

### Monitoring environmental conditions and chamber water quality.

Subsurface sea conditions were monitored using a Hydrolab DataSonde. The data were used to identify target water quality parameters for chamber operations and broodstock maintenance. The Sonde was factory fit with depth ( $\pm 0.03$  m), dissolved oxygen ( $\pm 0.01$  mg/L), temperature ( $\pm 0.01^\circ\text{C}$ ), pH ( $\pm 0.01$  unit), salinity ( $\pm 0.01$  ppt), and PAR ( $\pm 1$ ). Measurements were recorded every 30 seconds as the probe was lowered to depth at targeted fishing areas. A Reefnet Sensus Pro depth recorder was used to record changes in pressure as the fish were being caught by hook and line, recompressed, and decompressed in the chamber. The depth recorder was programmed to log data every 10 seconds when attached to the fisherman's line, and every 30 seconds when placed



in the chamber. The Reefnet logger measured depth to the nearest 0.3 meters.

Water quality was monitored externally and internally of the chamber. Externally water quality was monitored downstream of each chamber using an Oxyguard Handy Gamma probe. The probe was factory fit with temperature ( $\pm 0.1^\circ\text{C}$ ) and dissolved oxygen ( $\pm 0.1\%$ ). Measurements were recorded at hourly intervals while on the boat and every few hours in the laboratory during the daytime. Measurements and observations were also recorded at night between staged decompression plateaus. For continuous in-chamber measurements an Onset Tidbit temperature probe was deployed to record temperature every 30 seconds to the nearest  $0.01^\circ\text{C}$ . No other water quality parameters were measured for the chambers.

**Decompression sequence.** Fish were stabilized at depth for 20 to 25.5 hours prior to beginning their decompression sequence. Four to six hours into the initial stabilization period the chambers were isolated (valves closed and disconnected from the water source on the boat) and transported back to the laboratory. Transportation times took no longer than 25 minutes, at which point water flow was reestablished to the chambers from the laboratory supply system. After the stabilization period, fish were decompressed manually in stages typical of those performed by scuba divers practicing a safety stop. This routine allowed for a relatively rapid change in pressure with an extended period of time to decompress at the new pressure. This extended stabilization period allowed fish to equalize internal gas concentrations with those of the environment, reducing the possibility of bubble formation in the circulatory system.

Ascent rates used to calculate minimum time required to “off gas” varied from 1.8 to 0.9 m/min depending on depth. Ascent rates were: 1.8 m/min below 61.0 m, 1.5 m/min between 30.5 and 61.0 m, 1.2 m/min between 15.2 and 30.5 m, and 0.9 m/min between 0 and 15.2 m.

**Termination of decompression.** At the end of each decompression sequence, the chamber was set vertically (blind flange up) and the blind flange was removed. The fish was then sluiced into a custom-built, vinyl sling and placed into a 1.5 m diameter pool. The chambers were cleaned with freshwater and scrubbed as needed between uses. Maintenance of the system was also conducted at this time.

## Field Trials

Our apparatus was used to recompress and decompress 14 cowcod. The fish were recompressed to pressures equivalent to  $84.7\text{ m} \pm 2.2\text{ m}$  in depth. The average time taken to place the fish in the chamber and seal the lid on the chamber was  $8.0\text{ minutes} \pm 1.4\text{ minutes}$  and the average time taken to recompress the fish to the desired pressure was  $1.8\text{ minutes} \pm 0.9\text{ minutes}$ . Recompression rates ranged from 20.5 to 164.3 m/min with an average of  $63.6\text{ cm} \pm 37.6\text{ m}$ .

Following recompression, the cowcod were allowed to stabilize for 20 to 25.5 hours. After that period fish were decompressed at a rate of 1.4 m/min to sequential target stabilization depths (plateaus). The stabilization depths typically were  $75.8\text{ m} \pm 0.6\text{ m}$ ,  $60.4\text{ m} \pm 0.5\text{ m}$ ,  $47.0\text{ m} \pm 0.2\text{ m}$ ,  $31.5\text{ m} \pm 0.5\text{ m}$ ,  $18.0\text{ m} \pm 0.2\text{ m}$ ,  $11.1\text{ m} \pm 0.4\text{ m}$ ,  $4.1\text{ m} \pm 0.3\text{ m}$ , and  $3.6\text{ m} \pm 1.0\text{ m}$ . Stabilization times at those depths ranged from 5.4 to 11.0 hours depending on scheduling and initial stabilization depth. Total recompression decompression treatments lasted from 73.4 to 150.4 hours and produced healthy viable specimens (Figure 5).

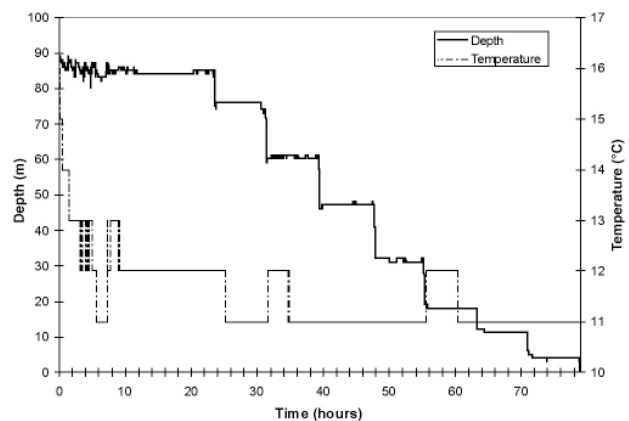

**Figure 5.** Decompression profile for one of 14 cowcod successfully collected by HSWRI. Pressure readings converted to actual or simulated depths with water temperature also shown.

**Water temperature.** Variation in water temperature in the chamber was dependent on the operation of chillers both on the boat and in the laboratory. On the boat the initial temperature in the chamber was warmer than desired because chilled seawater was not circulated through the chambers while waiting for fish to be captured. During the recompression sequence chilled water was circulated and the temperature inside the chamber quickly decreased from a maximum of  $18^\circ\text{C}$  to the target temperature of

approximately 12°C. This usually occurred in the first 30 minutes of operation and thereafter the temperature stayed relatively constant.

## Conclusion

The hyperbaric chamber was used successfully to recompress, transport, and decompress a species never before maintained in captivity. The apparatus is portable and capable of stable operation under a variety of field and laboratory conditions. The system is also relatively inexpensive to build, operate, and maintain. Further modifications to the hatch design are being evaluated to expedite the process of inserting the fish and initiating the recompression sequence. This modification may also facilitate future attempts to use the chamber under water, so that fish do not need to ascend all the way to the surface before being placed in the chamber. In the future we plan to collect other species for breeding purposes. We also plan to use the chambers in the laboratory to conduct studies to determine species and size-specific differences in susceptibility to barotrauma.

## References

- Beyer, D. L., B. G. D'Aoust, and L.S. Smith. 1976. Decompression-induced bubble formation in salmonids: Comparison to gas bubble disease. *Undersea Biomed. Res.* 3(4):321–338.
- Feathers, M. G., and A. E. Knable. 1983. Effects of depressurization upon largemouth bass. *N Am. J. Fish. Manag.* 3:86–90.
- Gitschlag, G. R., and M. L. Renaud. 1994. Field experiments on survival rates of caged and released red snapper. *N. Am. J. Fish. Manag.* 14:131–136.
- Gotshall, D. W. 1964. Increasing tagged rockfish (genus *Sebastes*) survival by deflating the swim bladder. *Calif. Fish Game* 50:253–260.
- Jannasch, H. W., C. O. Wiren, and C. L. Winget. 1973. A bacteriological pressure-retaining deep-sea sampler and culture vessel. *Deep-Sea Res.* 20:661–664.
- Keniry, M. J., W. A. Brofka, W. H. Horns, and J. E. Marsden. 1996. Effects of decompression and puncturing the gas bladder on survival of tagged yellow perch. *N. Am. J. Fish. Manag.* 16:201–206.
- Koyama, S., T. Miwa, M. Horii, Y. Ishikawa, K. Horikoshi, and M. Aizawa. 2002. Pressure-stat aquarium system designed for capturing and maintaining deep-sea organisms. *Deep-Sea Res.* 49:2095–2102.
- Lee, D. P. 1992. Gas bladder deflation of depressurized largemouth bass. *N. Am. J. Fish. Manag.* 12:662–664.
- Macdonald, A. G., and I. Gilchrist. 1978. Further studies on the pressure tolerance of deep-sea crustacean, with observations using a new high-pressure trap. *Mar. Biol.* 45:9–21.
- Rogers, S. G., H. T. Langston, and T. E. Targett. 1986. Anatomical trauma to sponge-coral reef fishes captured by trawling and angling. *Fish. Bull.* 84:697–704.
- Wilson, R. R. Jr., and K. L. Smith Jr. 1985. Live capture, maintenance, and partial decompression of a deep-sea grenadier fish (*Coryphaenoides acrolepis*) in a hyperbaric trap-aquarium. *Deep-Sea Res.* 32:1571–1582.
- Yayanos, A. A. 1978. Recovery and maintenance of live amphipods at a pressure of 580 bars from an ocean depth of 5700 meters. *Science* 200:1056–1059.



# **A Preliminary Report on the Use of *Porphyra* Protoplast as a Food Substitute for Culturing Aquatic Animals**

Takao Yoshimatsu  
National Research Institute of Aquaculture  
Fisheries Research Agency  
Mie 516-0193, Japan  
takaoyos@fra.affrc.go.jp

Alok Kalla and Toshiyoshi Araki  
Mie University  
Graduate School of Bioresources  
Mie 514-8507, Japan

Dong-Ming Zhang  
Kyushu University  
Graduate School of Bioresource and Bioenvironmental Sciences  
Fukuoka, 812-8581, Japan

Shuichi Sakamoto  
Oriental Yeast Industry Co. Ltd.  
Tokyo 174-8505, Japan

**Keywords:** *Porphyra*, protoplast, feed, red sea bream, Manila clams

## **Abstract**

**Protoplasts are plant cells that have had their cell wall removed using either mechanical or enzymatic means. As protoplasts have no cell walls they are easily digestible when ingested by animals as food components. In the present experiment we investigated the availability of *Porphyra* protoplasts (PP) as a food supplement or live food substitute for culturing red sea bream and Manila clams in the laboratory. With respect to red sea bream, a PP supplemented diet improved the feed utilization efficiency and enhanced fish growth, although no remarkable effect was noted on carcass composition in either treatment group. Survival rate was improved by incorporating 5% PP in the diet. In Manila clams, high survival was obtained in both PP and diatom fed group. There appeared to be no difference in carcass composition between two adult shellfish groups fed on either PP or a natural diet. According to the experimental results obtained in these trials, *Porphyra* protoplasts proved to be a good food substitute candidate for culturing aquatic animals like finfish and bivalve spat.**

## **Introduction**

Purple laver, *Porphyra* spp., is known to be one of the most nutritious edible macroalgae (red algae) and its thin sheet-like processed products are well known as a wrapping material for a famous Japanese dish, sushi-rolls. *Porphyra* contains very high levels of various kinds of minerals, and vitamins such as vitamins A, B complex, C, and E. Laver is also a good source of digestible protein (Resource Council 2000). In addition, it is notable that *Porphyra* contains a high amount of taurine, an important amino acid for larval fish (Kim et al. 2005). Recently, efficient biotechnological techniques for

producing protoplasts from macroalgae using purified polysaccharases isolated from various bacteria were developed (Araki et al. 1987, 1998, 2000; Aoki et al. 1990). As a result, the practical mass production of PP became a reality.

Protoplasts are plant cells that have had their cell walls completely removed using either mechanical or enzymatic means. Spheroplasts are generally called something other than protoplasts because the cell wall tends not to be destroyed completely by enzymatic treatment and some parts of the outer cell wall still remain intact. As protoplasts have no cell

walls, they are easily digestible when ingested by animals as a food ingredient. In the present experiment we investigated the availability of *Porphyra* protoplasts (PP) as a live food substitute for culturing two types of aquatic animals: finfish and bivalve molluscs.

## Materials and Methods

The PP were prepared in the laboratory as follows. As the cell wall of this alga is composed of three kinds of polysaccharides ( $\beta$ -1, 4-mannan,  $\beta$ -1, 3-xylan, and porphyran), three enzymes ( $\beta$ -1, 4-mannanase;  $\beta$ -1, 3-xylanase; and agarase) were produced from various types of bacteria which have been isolated from marine environments (Araki et al. 1987, 1998, 2000; Aoki et al. 1990). Suitable conditions for preparing a large amount of PP in the laboratory were determined before the onset of rearing experiments. Included were determinations of the proper pH of the reaction mixture, concentration of each enzyme, and time and temperature of the reaction process, among others. Since it is particularly difficult to distinguish and separate protoplasts from spheroplasts in a whole reaction mixture, we use only the term protoplasts here when referring to combined enzymatic-treated product from *Porphyra*. After obtaining the protoplasts, they were subjected to freeze drying so the nutrient qualities were retained. Freeze-dried PP were ground and smashed into powder form manually using a mortar pestle. The particle size of PP after grinding was varied from several  $\mu\text{m}$  to several tens of  $\mu\text{m}$  depending on the level of enzymatic reaction that had occurred.

One hundred liter polycarbonate aquaria were stocked with 13 fish each (initial average body weight = 15.4 g  $\pm$  0.2 g) that were fed the experimental diets for 6 weeks. Each aquarium was aerated (400–600 mL/min) and supplied with flow through temperature-controlled seawater (32–34 ppt, 25°C) at 8 L/min under the artificial photoperiod of 12L:12D. Two kinds of semipurified diets (Table 1) with and without supplementation of 5% PP were formulated using brown fish meal as a major protein source (crude protein level after formulation: 48.7–51.0%). Every morning the diets were processed into moist material by adding 60% w/w of freshwater. They were fed *ad libitum* three times a day at 1000, 1400, and 1800 hours by hand. The daily feeding ration was about 6% of the mean wet body weight estimated from the growth curve obtained during biweekly measurement when all the experimental

fish were weighed individually after being anesthetized with 2-phenoxyethanol (500 mg/L).

**Table 1. Ingredient content and proximate analyses of the experimental diets for red sea bream.**

	With <i>Porphyra</i> Protoplast (PP)	Without <i>Porphyra</i> Protoplast (Control)
Average Initial Body Weight (g)	15.4 $\pm$ 0.2	15.4 $\pm$ 0.2
Average Final Body Weight (g)	65.9 $\pm$ 3.5*	57.0 $\pm$ 2.1*
Average Weight Gain (%)	331.2 $\pm$ 30.3*	269.5 $\pm$ 17.6*
Daily Growth Rate (%)	3.47 $\pm$ 0.16*	3.11 $\pm$ 0.11*
Final Survival Rate (% , range)	94.9–100	76.9–92.3
Feed Efficiency (%)	71.5 $\pm$ 0.9**	58.1 $\pm$ 3.5**
Protein Retention Rate (%)	38.3 $\pm$ 2.2**	29.3 $\pm$ 1.4**
Protein Efficiency Ratio	1.47 $\pm$ 0.02**	1.11 $\pm$ 0.08**
Condition Factor	31.0 $\pm$ 1.4 <sup>NS</sup>	30.7 $\pm$ 0.7 <sup>NS</sup>
Hepatosomatic Index	1.34 $\pm$ 0.34**	1.25 $\pm$ 0.09**
Viscerosomatic Index	6.58 $\pm$ 0.37**	6.36 $\pm$ 0.57**

See "Materials and Methods" for the formulae to calculate the biological parameters.

Values are represented as mean  $\pm$  SD obtained from triplicated groups, except for the final survival. Each superscript in a same row shows statistical significance.

(Student's t-test, \*: p<0.05, \*\*: p<0.01, <sup>NS</sup>: not significantly different)

At the end of the feeding trials, in addition to the body weight and length measurements, hepato- and viscero-somatic indices were calculated from the weights of individual bodies, livers, and viscera. Proximate analyses of liver and dorsal muscle were carried out from pooled samples of each group obtained after termination of the experiment. The biological parameters used for evaluating rearing results were defined and calculated as follows:

$$\text{Condition factor} = \text{body wet weight (g)} \times 1000 / \text{body length}^3 \text{ (cm)}.$$

$$\text{Hepatosomatic index (HSI)} = \text{liver wet weight (g)} \times 100 / \text{body wet weight (g)}.$$

$$\text{Viscerosomatic index (VSI)} = \text{whole visceral wet weight (g)} \times 100 / \text{body wet weight (g)}.$$

$$\text{Daily growth rate} = (\ln W_f - \ln W_i) \times 100 / \text{rearing period (days)}, \text{ where } W_f \text{ and } W_i \text{ are final and initial mean wet body weights (g), respectively.}$$

$$\text{Feed efficiency} = \text{body wet weight gain} \times 100 / \text{dry weight of feed fed (g)}.$$

$$\text{Protein retention rate} = \text{dorsal muscle protein gain (g)} \times 100 / \text{protein fed (g)}.$$

$$\text{Protein efficiency ratio} = \text{body wet weight gain (g)} / \text{protein fed (g)}.$$

The trials with bivalves were conducted as follows. Manila clam (*Ruditapes philippinarum*) spat were obtained from a hatchery. Spat (6-months-old, mean shell length 5.34 mm) were randomly distributed in small stainless steel mesh cages (10 cm diameter), with 20 individuals each in six replicates receiving each dietary treatment and reared in a flowthrough system of temperature controlled seawater (32–34 ppt, 20°C) for 6 weeks. Two diets

(PP and condensed natural diatoms [*Chaetoceros gracilis*] Tasaki Shinju Co. Ltd., Japan) were fed *ad libitum* to the clams four times a day (0800, 1200, 1600, and 2000 hours) by stopping the water flow until clams complete consuming the food. Adult clams (mean shell length 35.3 mm) were reared under the same conditions as those used with spat and for the same period. Before feeding, the PP was mixed with sea water using an electric mixer and offered to the clams in liquid form. The dietary performance was evaluated by growth of the shells, body composition and survival.

## Results

Proximate compositions of dried *Porphyra* and the PP are shown in Table 2. After enzymatic processing of *Porphyra* the protein and lipid contents increased while crude ash content decreased due mainly to the digestion of the cell wall polysaccharides.

**Table 2. Proximate composition of *Porphyra* protoplasts.**

Composition (%)	Dried <i>Porphyra</i>	<i>Porphyra</i> Protoplast
Moisture	8.4±0.5	5.9±0.1
Crude Protein	29.1±0.2	36.7±0.7
Crude Lipid	0.1±0.0	2.9±0.2
Crude Ash	10.9±0.1	3.5±0.1

Values are represented as mean ± SD (n=3).

The rearing results of red sea bream fed on test diets with (PP) or without PP supplementation (control) are summarized in Table 3. After 6 weeks of feeding the fish reached 65.9 g ±3.5 g in the PP group, but only 57.0 g ±2.1 g in the control group. There was more than a 60% difference in the percentage of average weight gained between the PP and control groups ( $p < 0.01$ ). As a result, a significantly better ( $p < 0.01$ ) daily growth rate (3.47% ±0.16%) was obtained in the PP group compared with the control group (3.11% ±0.11%). In addition, survival was better in PP group (94.9–100%). As for feed utilization, the PP group showed better results in feed efficiency, protein retention rate, and protein efficiency than the control group, although the two test diets had no major differences in their proximate compositions (Table 2). There was no significant difference in condition factor between the PP and control groups. Nevertheless, higher values were obtained in both HSI and VSI for the PP group. In Table 4, proximate compositions of the dorsal muscle sampled from test fish after the termination of the feeding trial are shown. After 6 weeks feeding, both

PP and control fish showed reduced moisture content and increased crude protein and lipid content. However, there were no significant differences in proximate analyses data between them ( $p > 0.05$ ).

**Table 3. Effect of *Porphyra* protoplast supplementation on the growth and feed utilization by red sea bream.**

	With <i>Porphyra</i> Protoplast (PP)	Without <i>Porphyra</i> Protoplast (Control)
Average Initial Body Weight (g)	15.4±0.2	15.4±0.2
Average Final Body Weight (g)	65.9±3.5*	57.0±2.1*
Average Weight Gain (percent)	331.2±30.3*	269.5±17.6*
Daily Growth Rate (percent)	3.47±0.16*	3.11±0.11*
Final Survival Rate (percent and range)	94.9-100	76.9-92.3
Feed Efficiency (percent)	71.5±0.9**	58.1±3.5**
Protein Retention Rate (percent)	38.3±2.2**	29.3±1.4**
Protein Efficiency Ratio	1.47±0.02**	1.11±0.08**
Condition Factor	31.0±1.4 <sup>NS</sup>	30.7±0.7 <sup>NS</sup>
Hepatosomatic Index	1.34±0.34**	1.25±0.09**
Viscerosomatic Index	6.58±0.37**	6.36±0.57**

See "Materials and Methods" for the formulae to calculate the biological parameters.

Values are represented as mean ± SD obtained from triplicated groups, except for the final survival.

Each superscript in a same row shows statistical significance.

(Student's *t*-test, \*:  $p < 0.05$ , \*\*:  $p < 0.01$ , <sup>NS</sup>: not significantly different)

**Table 4. Proximate compositions of the dorsal muscle of red sea bream fed on *Porphyra* protoplast.**

**Figure 1. Increase in shell length of spat fed PP as compared with diatoms over a 6 week experimental period.**

Composition (%)	Initial	With <i>Porphyra</i> Protoplast (PP)	Without <i>Porphyra</i> Protoplast (Control)
Moisture	79.9±1.1	76.0±1.4 <sup>NS</sup>	76.0±0.5 <sup>NS</sup>
Crude Protein	15.9±0.2	20.0±0.6 <sup>NS</sup>	19.2±0.6 <sup>NS</sup>
Crude Lipid	1.4±0.1	2.3±0.4 <sup>NS</sup>	1.7±0.1 <sup>NS</sup>
Crude Ash	2.6±0.1	2.1±0.1 <sup>NS</sup>	2.0±0.1 <sup>NS</sup>

Values are represented as mean ± SD obtained from triplicate groups.

<sup>NS</sup>: Not significantly different (Student's *t*-test,  $p > 0.05$ ).

A review of preliminary trial data on length increase indicated that clams fed on natural diatoms grew faster than the clams fed the PP diet (Figure 1,  $p < 0.01$ ). Nevertheless, over-all mortality was low (97.5–99.2%) and independent of the experimental treatments. Also, no significant variation was observed in proximate carcass composition after the feeding trial for adult clams (Table 5). After 6 weeks rearing, both PP and natural diatom-fed groups showed reduced moisture content and increased crude protein and lipid contents; the same result as obtained in red sea bream.

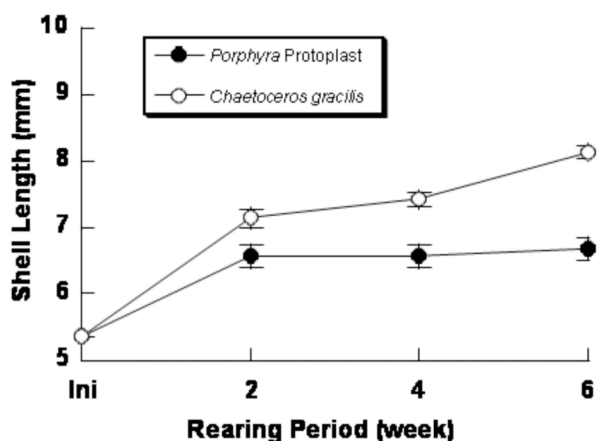

Figure 1. Increase in shell length of spat fed PP as compared with diatoms over a six week experimental period.

Table 5. Proximate composition of Manilla clam fed on *Porphyra* protoplast and *Chaetoceros gracilis*.

Composition (%)	Initial	<i>Porphyra</i> Protoplast (PP)
Moisture	81.5±0.9	81.4±0.3*
Crude Protein	6.8±0.2	7.1±0.1 <sup>NS</sup>
Crude Lipid	0.8±0.1	0.9±0.1 <sup>NS</sup>
Crude Ash	2.1±0.1	2.1±0.1 <sup>NS</sup>

Values are represented as mean ± SD obtained from triplicate groups.

Each superscript in a same row shows statistical significance. (Student's *t*-test, \*:  $p < 0.05$ , <sup>NS</sup>: not significantly different)

## Discussion

In red sea bream, a PP supplemented diet improved feed utilization efficiency and enhanced fish growth (Table 3), although no notable effects were obtained with respect to carcass composition of the fish used in the two treatments (Table 4). Dietary protein utilization was improved significantly by supplementing PP as shown in Table 3. As a feed ingredient, protein is the most important dietary element and its efficient utilization must be thought of as the first priority when formulating a fish food. The experimental results obtained in this feeding trial show that PP has great potential as a food supplement from the viewpoint of efficient utilization of dietary protein. Survival rate was also improved by the supplementation of 5% PP to the diet.

Nakagawa (2005) summarized information indicating that small amounts of various kinds of macroalgal supplementation to the diet improves fish growth and feed efficiency, mainly due to an improvement in lipid metabolism. Algal supplementation to fish feed was previously reported to be effective either by enhancing the immune

system or activating fat accumulation/mobilization as well as improving absorption, assimilation, and retention (Mustafa et al. 1995). Nevertheless, reports of the supplemental effect of microalgal protoplasts have apparently not been published to date.

Enhanced feed efficiency of red sea bream obtained in the present experiment, when fed with diet supplemented with 5% PP, may also be attributed to the probable presence of a food attractants, vitamins, minerals, essential amino acids, and taurine. Also, physiological changes induced through dietary PP supplementation might have affected the feeding behavior and efficiency of the test fish. At the moment, we do not know the mechanism by which PP supplementation improved the dietary value of the feed for red sea bream in this feeding trial. Further study is needed to clarify this point.

As for the results obtained in the clam experiment, PP proved to be a good food source for culturing not only grown shellfish but also spat. Under the experimental conditions employed, growth in PP group of spat was inferior to that of spat fed diatoms (Figure 1). Nevertheless, final survival was high and almost same in the PP-fed group as in natural food group. As there appeared to be no difference in carcass composition between the two groups, it should be possible in the future to improve the dietary effect by manipulating feeding techniques and ingredients added to PP diet to enhance its quality.

According to the experimental results obtained in these culture trials, the protoplasts of *Porphyra* proved to be a good food substitute for culturing aquatic animals like finfish and bivalve spat. We should continue investigating the applicability of PP and determine what kind of nutrients must be supplemented to enhance the dietary value to meet the nutritional requirements of these aquatic animals and develop the feeding techniques that might enhance the performance of the PP.

## Acknowledgment

This study was supported by a grant program of the Agriculture, Forestry, and Fisheries Research Council in Japan (Research project for utilizing advanced technologies in agriculture, forestry, and fisheries. No.1681, 2004-2006, Studies on the effective utilization of low-grade *Porphyra* by enzymatic means).

## References

- Aoki, T., T. Araki, and M. Kitamikado. 1990. Purification and characterization of a novel beta-agarase from *Vibrio* sp. AP-2. *Eur. J. Biochem.* 187:461–465.
- Araki, T., T. Aoki, and M. Kitamikado. 1987. Preparation and regeneration of protoplasts from wild-type of *Porphyra yezoensis* and green variant of *P. tenera*. *Nippon Suisan Gakk.* 53:1623–1627.
- Araki, T., Z. Lu, and T. Morishita. 1998. Optimization of parameters for isolation of protoplasts from *Gracilaria verrucosa* (Rhodophyta). *J. Mar. Biotechnol.* 6:193–197.
- Araki, T., S. Hashikawa, and T. Morishita. 2000. Cloning, sequencing, and expression in *Escherichia coli* of the new gene encoding  $\beta$ -1, 3-xylanase from a marine bacterium, *Vibrio* sp. strain XY-214. *Appl. Environ. Microbiol.* 66:1741–1743.
- Halver, J. E. 1957. Nutrition of salmonoid fishes—III. Water-soluble vitamin requirements of Chinook salmon. *J. Nutr.* 62:225–243.
- Kim, S.K., T. Takeuchi, A. Akimoto, H. Furuita, T. Yamamoto, M. Yokoyama, and Y. Murata. 2005. Effect of taurine supplemented practical diet on growth performance and taurine contents in whole body and tissues of juvenile Japanese flounder *Paralichthys olivaceus*. *Fish. Sci.* 71:627–632.
- Mustafa, M. G., S. Wakamatsu, T. Takeda, T. Umino, and H. Nakagawa. 1995. Effects of algae meal as feed additive on growth, feed efficiency, and body composition in red sea bream. *Fish. Sci.* 61:25–28.
- Nakagawa, H. 2005. Effective utilization of macroalgal waste as feed ingredients for aquaculture. *In* M. Sakaguchi and T. Hirata (eds.), *Advanced effective utilization of fish and fisheries products*, p. 292–300. NTS Press, Tokyo, Japan.
- Resource Council. 2000. *Algae. In Standard tables of food composition in Japan* (Fifth revised edition), p. 152–159. Science and Technology Agency, Tokyo, Japan.





# **Aquaculture and Stock Enhancement Technologies Based on Recently Discovered Calcium-sensing Receptors in Finfish**

Steve Jury, H. William Harris, Timothy Linley,  
David Russell, Marlies Betka, and Susan Anderson  
MariCal Inc.  
Portland, Maine USA (www.marical.biz)  
sjury@marical.biz

Shinji Harakawa and Akikuni Hara  
Hakuju Institute for Health Science, Tokyo, Japan (www.hakuju.co.jp)

**Keywords:** calcium sensing receptor, salinity, enhancement, salmon, cobia, aquaculture

## **Extended Abstract**

**Recent discoveries that calcium-sensing receptors (CaRs) act as salinity sensors and are involved in sensory reception in finfish provides a basis for the development of multiple technologies designed to improve aquaculture and stock enhancement efforts in the U.S. and Japan. The combination of molecular cloning, cell biology, and physiological experiments show that CaRs play key roles in finfish osmoregulation and physiological adaptation to varying salinity environments. Important CaR-mediated roles in finfish appear to involve not only osmoregulatory acclimation via gill, renal and intestinal tissues, but also changes in endocrine as well as olfactory responses. Taken together, these data provide support for CaRs as regulators of the multiple physiological and behavioral changes occurring during smoltification in salmonid species.**

Based on knowledge of the ionic pharmacology of CaRs, juvenile salmonids can be pre-adapted to seawater while they remain in freshwater. Alternatively, marine fish species normally restricted to seawater can be maintained under near freshwater conditions. In this regard, the SuperSmolt and SeaReady processes are currently being licensed to salmon aquaculture and stock enhancement producers. Both of these technologies are applied to fish reared in tanks where mineral salts are added to the rearing water and fish are fed a diet containing elevated NaCl and a naturally occurring CaR-reactive amino acid for an interval of 3–6 weeks. Thus the resulting biological changes are induced by manipulation of natural processes and do not involve genetic modifications. These changes are monitored using enzymatic (e.g., gill  $\text{Na}^+\text{K}^+\text{ATPase}$ ) and physiological (e.g., seawater challenge, plasma chloride level) tests to determine development of seawater tolerance. In farmed Atlantic salmon (*Salmo salar*), the SuperSmolt process reduces the deleterious effects of incomplete smoltification after the transfer of smolts to seawater. This improves both the growth and feed conversion ratios while reducing mortalities during growout in seawater. In Chinook, coho, and sockeye salmon (*Oncorhynchus tshawytscha*, *O. kisutch*, *O. nerka*), the SeaReady process improves the osmoregulatory and growth performance in the early seawater rearing environment and preliminary data suggest that this may increase the number and performance of adult returns. The SuperSmolt process has been recently tested and endorsed by EWOS, a major aquaculture feed producer. By contrast, CaR modulation in marine fish such as cobia (*Rachycentron canadum*) enables their production under very low salinity conditions, providing inland growers or those utilizing recirculation technologies the option to produce high value marine species.

Research by MariCal and Hakuju has also focused on the roles of CaRs in sensory biology, including salinity reception, olfaction, and the response of fish to electric fields via lateral line or specific electroreceptor tissues. Since a gradient of charged ions ( $\text{Na}^+$ ,  $\text{Cl}^-$ ,  $\text{Mg}^{2+}$  or  $\text{Ca}^{2+}$ ) is likely involved in salinity as well as electric field detection, CaRs in specific tissues may provide a molecular means to “sense” and integrate changes in both the ionic and electric field environments that fish may encounter. While much of this research is ongoing, we conclude that this CaR-based approach has considerable potential to improve aquaculture and stock enhancement technologies in the U.S. and Japan.

**Background.** CaRs are part of a family of G-protein coupled receptors that are closely related to metabotropic glutamate and pheromone receptors and are highly conserved between all species tested (Breitwieser et al. 2004, Ingleton et al. 1999, Figure 1). CaR proteins were first identified in human parathyroid glands and their role in calcium homeostasis has been firmly established (Brown and MacLeod 2001, Breitwieser et al. 2004, Chang and Shoback 2004). CaRs are responsive to physiologically and environmentally relevant changes in extracellular divalent cations such as  $\text{Ca}^{2+}$  and  $\text{Mg}^{2+}$  (Breitwieser et al. 2004), but are also modulated by other extracellular conditions including  $\text{NaCl}$  (Quinn et al. 1998, Loretz et al. 2004), specific amino acids (Conigrave et al. 2004), several heavy metals; e.g.,  $\text{Pb}^{2+}$  and  $\text{Al}^{3+}$  (Handlogten et al. 2000, Quinn et al. 2004), and pH (Doroszewicz et al. 2005, Quinn et al. 2004). CaRs have been found in multiple organs associated with osmoregulation and salinity detection in several fish species including Atlantic salmon (*Salmo salar*) (Nearing et al. 2002, Nearing et al. submitted), sea bream (*Sparus aurata*) (Flanagan et al. 2002), and tilapia (*Oreochromis mossambicus*) (Loretz et al. 2004). We have also characterized a full-length CaR cDNA from dogfish (*Squalus acanthias*) kidney (SKCaR) that is localized in kidney, olfactory lamellae, epithelial cells and vessels in the gastrointestinal tract, gills, and rectal gland (Nearing et al. 2002, Hentschel et al. 2003). Several studies have shown CaR in other fish species without molecular cloning of their full-length transcripts or proteins. These species include the flounders, *Platichthys flesus* (Ingleton et al. 1999) and *Pleuronectes americanus* (Nearing et al. 2002), and goldfish, *Carassius auratus* (Hubbard et al. 2002).

The potential role of CaRs as regulators of  $\text{Ca}^{2+}$  homeostasis in fish has been emphasized (Hubbard et al. 2000, 2002, Ingleton et al. 1999, Radman et al. 2002, Fellner and Parker 2002, Loretz et al. 2004, Nearing et al. submitted), but many of these studies have also suggested the involvement of CaRs in salinity sensing in fish (Nearing et al. 2002, Hubbard et al. 2002, Loretz et al. 2004, Nearing et al. submitted).

Thus CaRs are present and functional in various tissues of multiple teleost species, and we propose that they are important in the integration of several physiological and behavioral processes of concern to the aquaculture and stock enhancement industries. We have used the approach of studying receptor biology to address problems of concern in hatchery production of anadromous and marine species. In

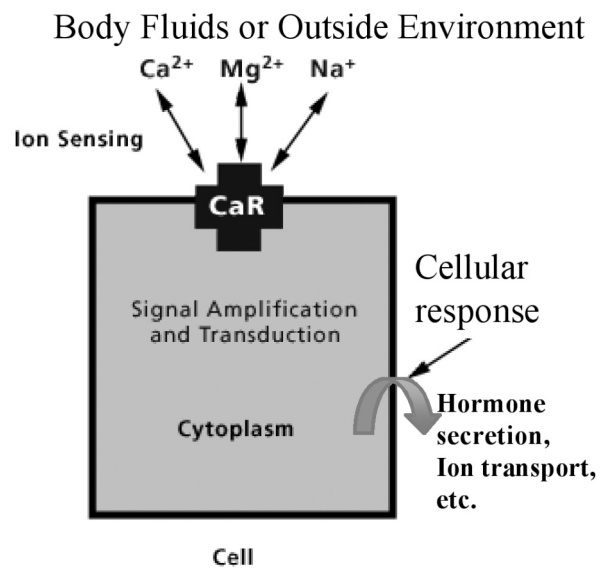

**Figure 1.** Calcium-sensing receptors (CaR) are integrators of extracellular and environmental signals leading to various intracellular responses.

this report we describe applications developed using this approach as well as an introduction to some research to develop additional technologies. These applications are: 1) SeaReady, 2) growing marine fish in near freshwater, and 3) the role of CaR in sensory biology.

**SeaReady.** Anadromous species, including salmonids, are able to survive in either freshwater or seawater due to osmoregulatory adjustments in tissues including gill, skin, kidney, and gastrointestinal tract. These are the same tissues where CaRs are localized (Nearing et al. submitted) and may be differentially expressed during seawater acclimation. The process of smoltification in salmonids raised under hatchery production conditions prepares salmon for the remodeling of their tissues after seawater transfer. These physiological changes must be accomplished within a limited interval of time and be matched to the movement of fish to higher salinity environments. These changes may occur naturally during a normal smolt timing window that is dependent on the species concerned. The complex changes that occur during smolting determine how ready salmonids are for a seawater existence. Smoltification has traditionally been manipulated under hatchery rearing conditions with varying degrees of success by changes in photoperiod, temperature, and feeding (McCormick et al. 1998). While the factors that initiate and control smoltification continue to be the subject of

many studies, they are not entirely understood. The variability in the effects of different methods, as well as logistic problems associated with hatchery rearing often leads to a gradient of incomplete smoltification and subsequent osmotically induced lethal and sublethal effects upon transfer of fish to seawater. These effects can include significant elevations in plasma ionic content resulting in the dysfunction of various organ systems, impaired ion homeostasis, abnormal swimming behavior, morphological changes, impaired feeding behavior, and often increased mortality.

Based on our understanding of the distribution and function of calcium-sensing receptors relative to osmoregulation, as well as the logistic and socioeconomic constraints of hatchery operations, Marical has developed the SeaReady (U.S. patent #6,748,900) and SuperSmolt (U.S. patent #6,463,883) processes as methods to enhance smoltification in salmonid fishes while they are still in the hatchery prior to release into rivers or transfer to seawater for growout. This process consists of manipulating the ionic environment (e.g.,  $\text{Ca}^{2+}$  and  $\text{Mg}^{2+}$ ) as well as application of feed additives (NaCl and CaR reactive amino acids) over a period of 4–6 weeks (Figure 2).

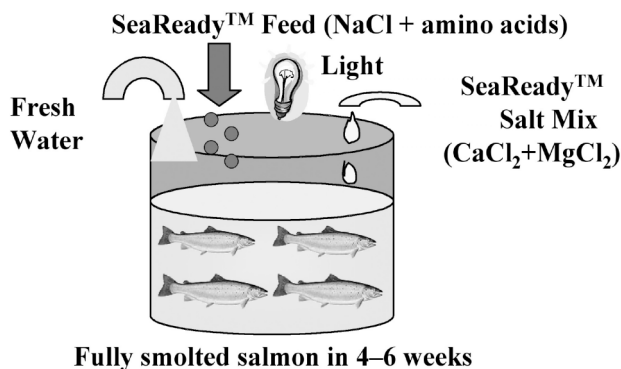

Figure 2. SeaReady process overview.

SeaReady serves to preadapt salmon to seawater and allows for improved performance upon transfer to seawater. In terms of stock enhancement, we propose that this improved early seawater performance will lead to enhanced ocean survival (Linley 2000) and subsequent improved returns. Benefits include the ability to transfer fish to seawater at smaller sizes, transferring of smolts outside of their traditional species specific smolt timing windows (e.g., fall entry), reduced feeding inhibition upon seawater transfer, and improved

growth during seawater rearing. This process has been successfully tested on multiple species (Atlantic salmon, Chinook, coho, and sockeye salmon) in multiple locations on over 3 million smolts. We believe that there may be additional effects of this preadaptation process, including priming for imprinting, manipulating residualization, decreased estuarine residency time (and thus decreased predation in early marine life history), as well as improved ocean survival and subsequent improved returns of released fish (Linley 2000). However, these effects remain to be quantified.

### Growing marine fish in near freshwater.

Acclimating marine species to grow in freshwater or near freshwater conditions offers multiple benefits for hatchery production. For certain applications, freshwater recirculating systems are more feasible on a commercial scale to raise marine species, then transfer them to marine sites for growout. This would allow for raising fish to a larger size under controlled hatchery conditions, potentially at a lower cost. The reasons for using freshwater systems include: 1) coastal property is very expensive for shore based tank farms and political/environmental pressures are restrictive along the coast in many areas, 2) environmental regulations limit the amount of saline water discharge and sludge disposal from recirculating facilities, 3) higher value marine species may be grown in systems currently culturing lower value species, and 4) freshwater culture of marine species may mitigate some disease issues.

We have patented (U.S. patent # 6,463,882) methods to grow marine species in near freshwater by manipulating the ionic composition of the rearing environment and adding CaR compounds to the feed to induce compensatory changes in the plasma. The fish are subjected to a gradual or step-wise decrease in salinity for a period of time prior to transfer to freshwater, while being fed a modified diet. The fish are then maintained in a near freshwater low salinity environment with an optional long day photoperiod for a sufficient period of time to increase or maintain expression or sensitivity of calcium-sensing receptors.

MariCal has been conducting feasibility studies with cobia (*Rachycentron canadum*) and has determined that cobia grow well in salinities as low as 2 ppt and can be successfully transferred from these conditions back to 35 ppt seawater. MariCal plans to grow cobia to market size in future large scale trials.

**Role of CaRs in sensory biology.** CaRs are expressed in most osmoregulatory tissues in salmon, but they are also found throughout the peripheral and central nervous systems (Nearing et al. 2002, Nearing et al. submitted). In particular CaRs have been found in the olfactory system (olfactory epithelia, olfactory bulb, olfactory nerve) as well as in electroreceptive organs (e.g., electric organs, ampullae of Lorenzini) of teleosts and elasmobranchs. Based on extracellular recordings of the olfactory nerve, we have determined that Atlantic salmon are responsive to calcium, magnesium, gadolinium, and strontium at concentrations that are consistent with CaR activation or modulation (Nearing et al. 2002, Nearing et al. submitted). On this basis, we propose that CaRs play a role in multiple osmoregulatory, and sensory functions in salmon which experience large changes in the concentration and composition of the ionic environments encountered during their normal life history. This has many implications for stock enhancement of salmonids including the role of CaRs in olfactory mediated behaviors such as imprinting, homing, mate selection, and predator avoidance. Our research programs have focused on the function of CaR in marine and aquatic organisms. Using information from these studies, we plan to continue developing applications useful to the stock enhancement and aquaculture industries.

**Conclusions.** The identification of CaRs in multiple tissues of many species of finfish is an important discovery opening an area of research on the integration of environmental and extracellular signalling of cations. Exposure of finfish to variable ionic environments under naturally occurring conditions (e.g., the typical life history of anadromous species) or under hatchery conditions (e.g., SeaReady) influences CaR signaling in specific tissues (e.g., gill, olfactory epithelia, electric organ). CaRs are likely to be involved in many physiological functions in the salmonid life cycle, and using an evolving understanding of the role of these receptors, we have developed technologies beneficial to the stock enhancement and aquaculture industries in the U.S. and Japan.

## References

- Breitweiser, G. E., S. U. Medlich, and M. Zhang. 2004. Calcium sensing receptors as integrators of multiple metabolic signals. *Cell Calcium* 35:209–216.
- Brown, E. M., and R.J. MacLeod. 2001. Extracellular calcium sensing and extracellular calcium signaling. *Physiol. Rev.* 81:239–297.
- Chang, W., and D. Shoback. 2004. Extracellular  $\text{Ca}^{2+}$ -sensing receptors-an overview. *Cell Calcium* 35:183–196.
- Conigrave, A. D., H. Mun, L. Delbridge, S. J. Quinn, M. Wilkinson, and E. M. Brown. 2004. L-amino acids regulate parathyroid hormone secretion. *J. Biol. Chem.* 279:38151–38159.
- Doroszewicz, J., P. Waldegger, N. Jeck, H. Seyberth, and S. Waldegger. 2005. pH dependence of extracellular calcium sensing receptor activity determined by a novel technique. *Kidney Int.* 67:187–192.
- Fellner, S. K., and L. Parker. 2002. A  $\text{Ca}^{2+}$ -sensing receptor modulates shark rectal gland function. *J. Exp. Biol.* 205:1889–1897.
- Flanagan, J. A., L. A. Bendell, P. M. Guerreiro, M. S. Clark, D. M. Power, A. V. M. Canario, B. L. Brown, and P. M. Ingleton. 2002. Cloning of the cDNA for the putative calcium-sensing receptor and its tissue distribution in sea bream (*Sparus aurata*). *Gen. Comp. Endocr.* 127:117–127.
- Handlogten, M. E., C. Huang, N. Shiraishi, H. Awata, and R.T. Miller. 2000. Extracellular  $\text{Ca}^{2+}$ -sensing receptor is a promiscuous divalent cation sensor that responds to lead. *Am. J. Physiol.-Renal.* 279:F1083–1091.
- Hentschel, H., J. Nearing, H. W. Harris, M. Betka, M. Baum, S. C. Hebert, and M. Elger. 2003. Localization of  $\text{Mg}^{2+}$ -sensing shark kidney calcium receptor SKCaR in kidney of dogfish, *Squalus acanthias*. *Am. J. Physiol.-Renal.* 285:F430–439.
- Hubbard, P. C., E. N. Barata, and A. V. Canario. 2000. Olfactory sensitivity to changes in environmental  $[\text{Ca}^{2+}]$  in the marine teleost *Sparus aurata*. *J. Exp. Biol.* 203:3821–3829.
- Hubbard, P. C., P. M. Ingleton, L. A. Bendell, E. N. Barata, and A. V. Canario. 2002. Olfactory sensitivity to changes in environmental  $[\text{Ca}^{2+}]$  in the freshwater teleost *Carassius auratus*: An olfactory role for the  $\text{Ca}^{2+}$ -sensing receptor? *J. Exp. Biol.* 205:2755–2764.

- Ingleton, P. M., P. C. Hubbard, J. A. Danks, G. Elger, R. A. Sandford, and R. J. Balment. 1999. The calcium-sensing receptor in fishes. *In* J. Danks, C. Dacke, G. Flik, and C. Gay (eds.), *Calcium metabolism: Comparative endocrinology*, p. 45–48. BioScientifica Ltd., Bristol, UK.
- Linley, T. 2000. Influence of short-term estuarine rearing on the ocean survival and size-at-return of coho salmon in southeast Alaska. *N. Am. J. Aquacult.* 63:306–311.
- Loretz, C. A., C. Pollina, S. Hyodo, Y. Takei, W. Chang, and D. Shoback. 2004. cDNA cloning and functional expression of a Ca<sup>2+</sup>-sensing receptor with truncated C-terminal tail from the Mozambique tilapia (*Oreochromis mossambicus*). *J. Biol. Chem.* 279:53288–53297.
- McCormick, S. D., L. P. Hansen, T. P. Quinn and R. L. Saunders. 1998. Movement, migration and smolting of Atlantic salmon (*Salmo salar*). *Can. J. Fish. Aquat. Sci.* 55:77–92.
- Naito, T., Y. Saito, J. Yamamoto, Y. Nozaki, K. Tomura, M. Hazama, S. Nakanishi, and S. Brenner. 1998. Putative pheromone receptors related to the Ca<sup>2+</sup>-sensing receptor in Fugu. *Proc. Natl. Acad. Sci.* 95:5178–5181.
- Nearing, J., M. Betka, S. Quinn, H. Hentschel, M. Elger, M. Baum, M. Bai, N. Chattopadhyay, E. M. Brown, S. C. Hebert, and H. W. Harris. 2002. Polyvalent cation receptor proteins (CaRs) are salinity sensors in fish. *Proc. Natl. Acad. Sci.* 99:9231–9236.
- Nearing, J., M. Betka, S. Jury and H.W. Harris. Submitted. Atlantic salmon (*Salmo salar*) express calcium-sensing receptors (CaRs) in various tissues. *J. Exp. Biol.*
- Quinn, S. J., O. Kifor, S. Trivedi, R. Diaz, P. Vassilev, and E. Brown. 1998. Sodium and ionic strength sensing by the calcium receptor. *J. Biol. Chem.* 273:19579–19586.
- Quinn, S. J., M. Bai, and E. M. Brown. 2004. pH sensing by the calcium-sensing receptor. *J. Biol. Chem.* 279:37241–37249.
- Radman, D. P., C. McCudden, K. James, E. M. Nemeth, and G. F. Wagner. 2002. Evidence for calcium-sensing receptor mediated stanniocalcin secretion in fish. *Mol. Cell. Endocrinol.* 186:111–119.
- Specca, D. J., D. M. Lin, P. W. Sorensen, E. Y. Isacoff, J. Ngai, and A. H. Dittman. 1999. Functional identification of a goldfish odorant receptor. *Neuron* 23:487–498.



# Biological Studies on the Digestive Mechanism in Abalone

Kentaro Niwa and Hideaki Aono  
National Research Institute of Fisheries Science  
6-31-1 Nagai, Yokosuka  
Kanagawa 238-0316, Japan.  
niwaken@affrc.go.jp

Tomoo Sawabe  
Laboratory of Microbiology  
Hokkaido University  
3-1-1 Minato-cho, Hakodate  
Hokkaido 041-8611, Japan

**Keywords:** abalone, *Vibrio halioticoli*, alginate lyase

## Abstract

**Abalone are one of the most important marine gastropods in Japan's coastal fishery. Recent studies on abalone suggest that the gut microbes work together with polysaccharide degrading enzymes of the host to digest seaweeds in the stomach. Genes encoding alginate lyase have been cloned from the digestive diverticulum of *Haliotis discus hannai* and *H. d. discus*. The bacterium, *Vibrio halioticoli*, with alginate degrading activity has also been isolated from the digestive fluid of various abalone species. However, the process by which the bacterium colonizes gut of abalone is unknown. Therefore, our goal is to clarify when colonization occurs and to what extent the bacterium contributes to digestion of polysaccharides.**

## Introduction

Abalone are economically important marine gastropods that bring moderate to high prices on the world market (Oakes and Ponte 1996). In Japan, there are six species of abalone, *Haliotis discus discus*, *H. discus hannai*, *H. madaka*, *H. gigantea*, *H. diversicolor diversicolor*, and *H. diversicolor aquatilis*, that are targets of coastal fisheries and aquaculture. Abalone ingest mainly algae, with a preference for brown algae. Abalone are distributed along the coastal reefs in Japan, where many kinds of kelp in the order Laminariales (brown algae) grow abundantly. *Laminaria* sp. is known to be the original source of alginate. Alginate accounts for more than 30% of the dry weight of the thallus in some algae. It is known that the cell walls of brown algae are formed by linkages of alginate and cellulose (Kloareg and Quatrano 1988). Alginate molecules consist of two homopolymeric structures: polymannuronate (polyM) block and polyguluronate (polyG) block, and a heteropolymeric part, which is randomly connected to manuronate to guluronate (MG random block). These polysaccharides are difficult to degrade by vertebrate digestive enzymes.

However, some kinds of herbivorous arthropods, nematodes and molluscs can degrade those polysaccharides. Many researchers have reported the

existence of alginate lyase in the digestive diverticulum of abalone (Tsujino and Saito 1962, Nakada and Sweeny 1967, Ohnishi et al. 1985, Boyen et al. 1990). Uki and Watanabe (in Shepherd 1992) investigated the nutritional requirements for the development of artificial feeds for abalone and suggested that abalone can efficiently use alginic acid as an energy source. It has been reported that alginate lyase detected from the digestive tract of abalone preferentially degraded the polyM block (Nakada and Sweeny 1967, Boyen et al. 1990). Alginate lyase specific for polyM was cloned from the digestive diverticulum of *H. discus hannai* (Shimizu et al. 2003). Recently, we succeeded in cloning of the equivalent gene from *H. discus discus* (in preparation). Furthermore, 68% of all alginolytic bacteria isolated from *H. discus hannai* showed a strong preference for the polyG block (Sawabe et al. 1998). Therefore, it is reasonable to speculate that the polyM part of ingested alginate is degraded by the digestive enzyme of the abalone, and the remaining polyG part is metabolized by these bacteria.

Sawabe et al. (1998) isolated a unique alginolytic marine bacterium from the gut of *H. discus hannai*. The bacterium was identified as *Vibrio halioticoli*, which was recognized as a new species (Sawabe et



al. 1995). The bacterium produced at least six types of alginate lyases, two of which were observed to be specific for polyM and four of which were specific for polyG.

*V. halioticoli* was detected from the gut of three species of the Japanese abalone, *H. discus discus*, *H. diversicolor aquatilis* and *H. diversicolor diversicolor*, and the South African abalone, *H. midae*, with a range of 40–65% among those microfloras (Sawabe et al. 2003). The bacterium was also found in the gut of a turban shell, *Turbo cornutus*, although the occupation rate was significantly smaller than that found in *Haliotis* spp. Furthermore, acetic acid and formic acid were detected as major fermentation products of alginate in the *V. halioticoli* strains. The acetate is absorbed from the gut tissue of abalone and metabolized as an oxidative energy source (Breznak 1982). It is suggested that the abundant populations of *V. halioticoli* in the gut of *Haliotis* abalone may have a great role for converting alginate to acetic acid (Sawabe et al. 2003).

The population of *V. halioticoli* in the gut of juvenile abalone increased when the diet was switched from diatoms to laminaria (Tanaka et al. 2003). Although the finding seems to suggest that the main source of the bacterium is thalli of laminaria, *V. halioticoli* has never been isolated from that alga. The main route and timing of gut colonization are not yet known. Therefore, we plan to clarify when *V. halioticoli* colonize the gut of the abalone and to what extent the bacterium contributes to digestion of polysaccharides.

## References

- Boyen, C., B. Kloareg, M. Polne-Fuller, and A. Gibor. 1990. Preparation of alginate lyase from marine mollusks for protoplast isolation in brown algae. *Phycologia* 29:173–181.
- Breznak, J. A. 1982. Intestinal microbiota of termites and other xylophagous insects. *Annu. Rev. Microbiol.* 36:323–343.
- Kloareg, B., and R. S. Quatrano. 1988. Structure of the cell walls of marine algae and ecophysiological functions of the matrix polysaccharides. *Oceanogr. Mar. Biol. Ann. Rev.* 26:259–315.
- Nakada, H. I., and P. C. Sweeny. 1967. Alginic acid degradation by eliminases from abalone hepatopancreas. *J. Biol. Chem.* 242:845–851.
- Oakes, F. R., and R. D. Ponte. 1996. The abalone market: Opportunities for cultured abalone. *Aquaculture* 140:187–195.
- Ohnishi, T., M. Suzuki, and R. Kikuchi. 1985. The distribution of polysaccharide hydrolase activity in gastropods and bivalves. *Bull. Jpn. Soc. Sci. Fish.* 51:301–308.
- Sawabe, T., Y. Oda, Y. Shiomi, and Y. Ezura. 1995. Alginate degradation by bacteria isolated from the gut of sea urchins and Abalones. *Microbial. Ecol.* 30:193–202.
- Sawabe, T., I. Sugimura, M. Ohtsuka, K. Nakano, K. Tajima, Y. Ezura, and R. Christen. 1998. *Vibrio halioticoli* sp.nov., a non-motile alginolytic marine bacterium isolated from the gut of the abalone *Haliotis discus hannai*. *Int. J. Syst. Bacteriol.* 48:573–580.
- Sawabe, T., N. Setoguchi, S. Inoue, R. Tanaka, M. Ootsubo, M. Yoshimizu, and Y. Ezura. 2003. Acetic acid production of *Vibrio halioticoli* from alginate: a possible role for establishment of abalone-*V. halioticoli* association. *Aquaculture* 219:671–679.
- Shepherd, S. A. 1992. Abalone of the World, p. 504-517. Fishing News Books, Oxford, UK.
- Shimizu, E., T. Ojima, and K. Nishita. 2003. cDNA cloning of an alginate lyase from abalone, *Haliotis discus hannai*. *Carbohydr. Res.* 338:2841–2852.
- Tanaka, R., I. Sugimura I., T. Sawabe, M. Yoshimizu, and Y. Ezura. 2003. Gut microflora of abalone *Haliotis discus hannai* in culture changes coincident with a change in diet. *Fish. Sci.* 68:227–229.
- Tsujino, I., and T. Saito. 1962. Studies on alginase. Part II. A new unsaturated uronide isolated from alginase hydrolysate. *Agr. Biol. Chem. Tokyo* 26:115–118.