

EFFECT OF DISSOLVED ORGANIC SUBSTANCES ON OYSTERS

**BY ALBERT COLLIER, S. M. RAY, A. W. MAGNITZKY
AND JOE O. BELL**

FISHERY BULLETIN 84

**UNITED STATES DEPARTMENT OF THE INTERIOR, Douglas McKay, *Secretary*
FISH AND WILDLIFE SERVICE, John L. Farley, *Director***

ABSTRACT

Sea water contains unknown substances in minute quantities which respond to the N-ethyl-carbazole test for carbohydrates. Pumping rates and shell gapes of several oysters recorded simultaneously indicated a parallel reaction to the concentration of carbohydrates in sea water. The oysters responded to increases in the carbohydrate concentration by pumping increasing amounts of water, and exhibited thresholds of lower limits below which they did not pump. Higher water temperatures elevated this threshold.

Analysis of shell movements revealed three phases of gape: Phase I, preliminary and equal to about one-third total gape; phase II, transitional; and phase III, induced only by a carbohydrate concentration above the threshold value.

Study of the behavior of the substances in sea water stored under controlled conditions established that light and air increase their production, and that they remain constant in the dark and in filtered water. There is an inverse, noncausal relation to salinity in natural estuarial water.

UNITED STATES DEPARTMENT OF THE INTERIOR, Douglas McKay, *Secretary*
FISH AND WILDLIFE SERVICE, John L. Farley, *Director*

EFFECT OF DISSOLVED ORGANIC SUBSTANCES ON OYSTERS

By ALBERT COLLIER, S. M. RAY, A. W. MAGNITZKY
and JOE O. BELL



FISHERY BULLETIN 84

From Fishery Bulletin of the Fish and Wildlife Service

VOLUME 54

UNITED STATES GOVERNMENT PRINTING OFFICE • WASHINGTON : 1953

For sale by the Superintendent of Documents, U. S. Government Printing Office, Washington 25, D. C.
Price 20 cents

CONTENTS

| | Page |
|----------------------------------------------------------------------|-------------|
| Techniques..... | 167 |
| Recording the activity of oysters..... | 167 |
| Collecting water samples..... | 168 |
| Characteristics of carbohydrates..... | 168 |
| Stability..... | 168 |
| Effects of filtering and centrifuging..... | 168 |
| Variations in carbohydrate concentrations in standing sea water..... | 169 |
| Relation of carbohydrate concentration to salinity..... | 169 |
| Diurnal variation..... | 171 |
| The oyster's response to carbohydrates..... | 173 |
| Analysis of shell movements..... | 173 |
| Effect of carbohydrates on pumping rate..... | 174 |
| Assimilation of carbohydrates..... | 177 |
| Anomalous responses..... | 179 |
| Summary..... | 181 |
| Literature cited..... | 182 |
| Appendix..... | 182 |
| Estimating carbohydrates in sea water..... | 182 |
| Measuring oyster activity..... | 183 |
| Description of sampling device..... | 183 |

EFFECT OF DISSOLVED ORGANIC SUBSTANCES ON OYSTERS

By ALBERT COLLIER and S. M. RAY, *Fishery Research Biologists*, A. W. MAGNITZKY, *Oceanographer*,
and JOE O. BELL, *Fishery Research Biologist*

In the course of prolonged and detailed studies of the effects of industrial wastes on oysters, *Crassostrea virginica* (Gmelin), continuous recordings of the activities of several oysters were made simultaneously. We noted that the oysters tended to behave in a parallel fashion which could not be correlated with any of the factors customarily measured. The work reported here presents our efforts to define the cause or causes. A preliminary paper on this subject (Collier, Ray, and Magnitzky, 1950), has demonstrated that an organic substance responding to the test for carbohydrates is associated with the activity of oysters.

There is a large body of information concerning the effect on oysters of those environmental factors which can be readily measured, including temperature, salinity, pH, turbidity, and oxygen content. Until recently, however, there have been no analytical estimates of continuous variations in the organic content of sea water and their relation to the activity of oysters. We were fortunate in having at our disposal a technique for estimating certain elements of the organic materials which react to the test for carbohydrates. J. Gordon Erdman suggested the method used here and adapted it to field conditions. The technique is described in the Appendix, page 182. It is important to note that all carbohydrate values are given in terms of arabinose equivalents, and do not necessarily reflect actual concentrations of carbohydrate substances.

It is our intent not to enter the argument concerning the utilization of dissolved organic materials by marine animals—an argument not yet closed (Korringa 1949)—but only to demonstrate the relation between the dissolved carbohydrates of sea water and the activity of oysters. This relation is discussed in the light of previous works

on oyster physiology, together with some practical and theoretical implications.

TECHNIQUES

RECORDING THE ACTIVITY OF OYSTERS

We chose the simultaneous recordings of shell movements and pumping rates as the best available index of physiological activity, since both lend themselves to uninterrupted recording over long periods of time. The degree of shell gape alone could not be used, because gape is only the prerequisite to the filtration of water, and as long as it exceeds a critical point, the flow of water through the gills may vary considerably. The rate of removal of artificially introduced suspended materials gives a useful index of activity for short periods, for it can be measured quickly and apparently without affecting the oyster significantly. The method is not suitable for long-term studies, however, because it does not lend itself to the continued automatic recording of the oyster's activity in such a way that maximum detail of behavior is discernible in the record at any moment. Also, the carmine-cone and drop-counting techniques (Galtsoff 1928a and 1928b, Galtsoff et al. 1935), have limited value for this type of extended experiment not only because they can be used only for short-term observations, but also because they may seriously interfere with the neurosensory network controlling the water flow through the body of the oyster. In the carmine-cone method, the accumulation of carmine cannot be easily controlled, and its effect on the oyster cannot be measured as the experiment progresses.

While the pumping rate may not necessarily indicate feeding rate, this is not a legitimate objection to the use of the pumping rate as an index of physiological activity. Because the oyster takes its food from the water, there can be no doubt that the more water it passes through its filtering system, the more food it can get.

Note.—Albert Collier, S. M. Ray, and Joe O. Bell, United States Fish and Wildlife Service; A. W. Magnitzky, United States Navy Hydrographic Office.

Realizing that the pumping rate is a resultant of all the factors that influence the oyster, we accept it as the best available measure of physiological activity. The method used in measuring the pumping rate is described in the Appendix, page 183.

COLLECTING WATER SAMPLES

Sea water was pumped from the bay and supplied to the laboratory at Pensacola, Fla., as a continuous flow without storage, because it was desired to follow the changes in the bay water as they occurred.

During the course of the work, it became apparent that water samples were required at frequent intervals, owing to the wide and frequent variations in salinity and carbohydrate concentration noted in our preliminary tests. In September 1948 we began taking samples every 2 hours throughout the day and night, and in November 1949, the interval was shortened to 1 hour. The samples were collected by means of a special device described in the Appendix (fig. A-2).

CHARACTERISTICS OF CARBOHYDRATES

STABILITY

Since the effects of storage on these organic compounds, which we have defined as carbohydrates, were not known, it was necessary to determine their stability while in storage so as to establish the validity of values from samples which had been collected in the automatic sampler. We assumed that no significant change would occur during the intervals between analyses, and tested this assumption by collecting a series of triplicate samples from the laboratory sea-water supply (table 1). In each series, one was analyzed immediately, one was held overnight at room temperature, and one was held overnight in the refrigerator. The mean difference between the samples analyzed immediately and those held in the refrigerator was plus 0.007 milligram/liter, and for those held at room temperature was plus 0.094 milligram/liter. Since even the larger of these differences was within the range of error of our readings, we accepted this method of sampling as adequate, despite the delays inherent in making the determinations.

TABLE 1.—Effect of standing time on carbohydrate concentration (mg./l.) of sea water at Pensacola, Fla., 1949

| Date | Hour | Immediate determination | Over-night in refrigerator | Difference | Over-night at room temperature | Difference |
|--------|------|-------------------------|----------------------------|------------|--------------------------------|------------|
| May 10 | 1200 | 15.4 | 15.5 | +0.1 | 15.5 | +0.1 |
| | 1400 | 15.5 | 15.4 | -.1 | 15.4 | -.1 |
| | 1200 | 11.3 | 11.3 | .0 | 11.2 | -.1 |
| 11 | 1400 | 12.6 | 12.8 | + .2 | 12.8 | + .2 |
| | 1000 | 14.4 | 14.4 | .0 | 14.4 | .0 |
| 16 | 1200 | 15.0 | 14.7 | -.3 | 15.2 | + .2 |
| | 1000 | 16.3 | 16.3 | .0 | 16.3 | .0 |
| 17 | 1200 | 16.3 | 16.3 | .0 | 16.8 | + .5 |
| | 1400 | 16.8 | 16.8 | .0 | 17.0 | + .2 |
| | 1000 | 8.6 | 8.6 | .0 | 8.7 | + .1 |
| 18 | 1200 | 6.6 | 6.0 | + .2 | 6.0 | + .2 |
| | 1400 | 6.6 | 6.6 | .0 | 6.8 | + .2 |
| | 1000 | 6.3 | 6.1 | -.2 | 6.3 | .0 |
| 19 | 1200 | 9.9 | 9.9 | .0 | 9.9 | .0 |
| | 1400 | 10.0 | 10.2 | + .2 | 10.2 | + .2 |
| 21 | 0800 | 10.7 | | | 10.7 | .0 |
| | 1000 | 11.5 | | | 11.5 | .0 |
| | 1200 | 11.2 | | | 11.2 | .0 |
| Mean | | | | + .007 | | + .094 |

EFFECTS OF FILTERING AND CENTRIFUGING

Since the carbohydrate content of diatoms or other organisms present in varying numbers as particulate matter might cause erratic results in the carbohydrate analysis, we tested the magnitude of this factor, by making a series of tests on filtered and on centrifuged sea water, both separately and in combination. The results of these tests are shown below.

Carbohydrate concentrations of three samples before and after centrifuging¹ showed the following changes:

| | Before | After | Loss |
|---------------|--------|-------|-------|
| Sample 1..... | 10.7 | 10.5 | -0.2 |
| Sample 2..... | 13.9 | 13.7 | -0.2 |
| Sample 3..... | 13.9 | 13.9 | ----- |

Carbohydrate concentration of four samples before and after filtering² showed the following changes:

| | Before | After | Loss |
|---------------|--------|-------|------|
| Sample 1..... | 11.5 | 11.3 | -0.2 |
| Sample 2..... | 11.2 | 11.2 | 0.0 |
| Sample 3..... | 13.9 | 13.6 | -0.3 |
| Sample 4..... | 14.1 | 13.9 | -0.2 |

From these results it became apparent that each method was effective in removing particulate matter. A sample containing 10.8 mg. of carbohydrates to the liter was then centrifuged and found to contain 10.5 mg. to the liter. An aliquot of that same sample, when filtered, contained an

¹ Centrifuged for 10 minutes at force 336. See Appendix, p. 182.

² Zeitz filter, porosity permitting 1.5 liters per hour at 40 millimeters vacuum.

identical amount, 10.5 mg./liter. The filtered sample, when centrifuged, showed no change. These experiments having demonstrated that either the 10-minute centrifuging or the filtering was sufficient to remove the particulate matter which might give erratic results, we adopted centrifuging as a standard part of the technique.

VARIATIONS IN CARBOHYDRATE CONCENTRATIONS IN STANDING SEA WATER

We assumed that sea water with carbohydrates dissolved in it would also contain the organisms necessary for their production. Further, if the sea water were kept in jars in the laboratory, changes in species composition and in the numbers of organisms in it would be reflected in varying concentrations of the carbohydrates. If these compounds were of biotic origin, they would be expected to increase more rapidly with aeration than without; and if the producers were phytoplankton, production would be inhibited in the absence of light. In any case, the production of carbohydrates would not be expected if the causative organisms were removed by filtering. Accordingly, a set of experiments was designed to vary the conditions for growth and, by inference, establish which group of organisms was responsible for the production of the carbohydrates.

In experiment A we filled duplicate jars with fresh sea water. One was supplied with air by means of a small aquarium pump connected at the bottom to a sintered glass block; the other was left undisturbed. Samples were taken from the center of the jars by siphons, so calibrated that the water standing in them could be measured and discarded at each sampling. These jars were kept about 15 feet from the west windows of the laboratory and no lights were kept on at night, an arrangement which was followed with the indicated modifications in the other experiments of the series. In this experiment it was evident that the production of carbohydrates was stimulated by aeration (fig. 1-A).

Agitation, as produced by the aerating apparatus, might have stimulated multiplication of the micro-organisms, and so account for the differences indicated in experiment A. To test this we set up experiment B, in which the surface water was gently ventilated without agitation. Samples were taken near the bottom of the jar

and from the surface of the water. The results show that the increased production of carbohydrates in the aerated water of experiment A was not due to agitation (fig. 1-B), but to the increased aeration. Here the carbohydrate concentration increased more rapidly and reached a higher concentration at the surface. It appears that part of the belated increase in the bottom concentration might have been the result of mixing due to convection currents in the jar.

In experiment C, filtered water was used to determine the sequence of changes when it could be assumed that the organisms which produce the substances had been removed from the water. As in experiment A, one jar was aerated and one was undisturbed. It was quite evident from the low carbohydrate concentration that the organisms producing these substances had been removed by filtration (fig. 1-C).

Experiment D was designed to demonstrate the role of light in the production of carbohydrates. The sequence of changes in both filtered and unfiltered sea water kept in the dark was followed. No significant changes in carbohydrate concentrations occurred in the absence of light (fig. 1-D).

From these experiments we may conclude that biotic activity is responsible for the production of carbohydrates, and that light and air create conditions favorable for the organisms producing these carbohydrates in sea water. It would be expected further that the responsible organisms are in part, if not altogether, photosynthetic, as indicated by the increased production in the presence of light. The effect of aeration is not so conclusive, for it is not known whether the air supplied carbon dioxide to plants, or oxygen to heterotrophic organisms (dinoflagellates).

RELATION OF CARBOHYDRATE CONCENTRATION TO SALINITY

We tabulated and averaged the carbohydrate-concentration values falling within salinity ranges of 2‰. Plotting of these averages shows an association between the concentration of carbohydrates and salinity (fig. 2). Between about 15‰ and 31‰ there is an apparent negative correlation between salinity and carbohydrates. From 7‰ to about 15‰ this relation is not clear and may not exist. The negative relation at the higher salinities may have been caused by the invasion

of the carbohydrate-poor, high-salinity waters of the Gulf of Mexico into the carbohydrate-rich and low-salinity waters of Santa Rosa Sound. Whether this means that the correlation is due to the falling off in the carbohydrate values in proportion to the volume of gulf water intruding, or reflects an inverse relation between carbohydrate production and salinity in gulf waters, is not

evident in these data. Lack of knowledge of the origin of these carbohydrates precludes speculation on the part that might be played by the salinity tolerance of the organisms responsible for their production. The association of carbohydrates with salinity illustrated could be the result of both physical dilution and biological interference due to salinity changes.

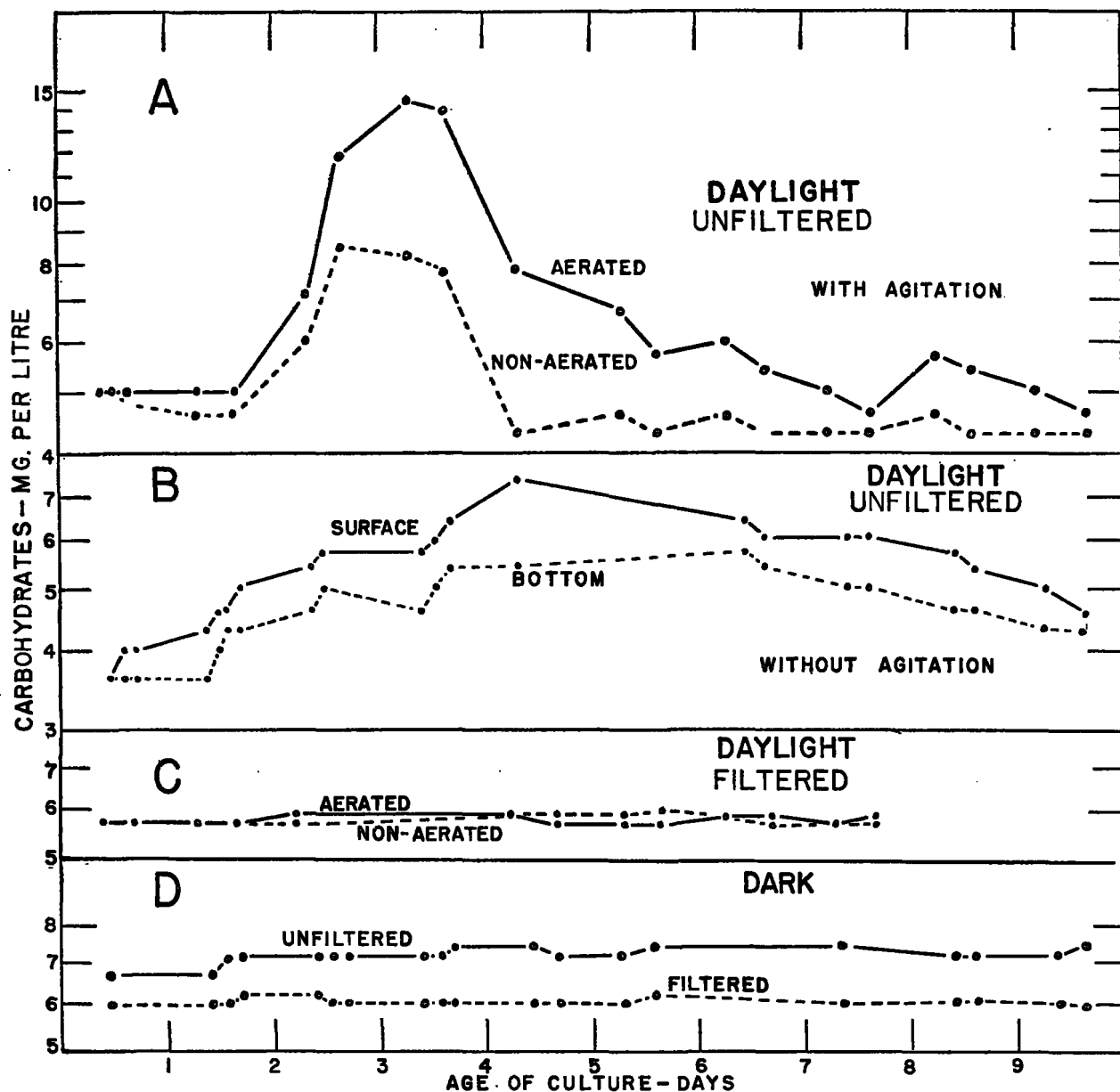

FIGURE 1.—Behavior of carbohydrates in standing sea water. A.—Exposed to daylight, unfiltered, with agitation. B.—Exposed to daylight, unfiltered, without agitation. C.—Exposed to daylight, filtered, aerated and nonaerated. D.—Kept in dark, filtered and unfiltered.

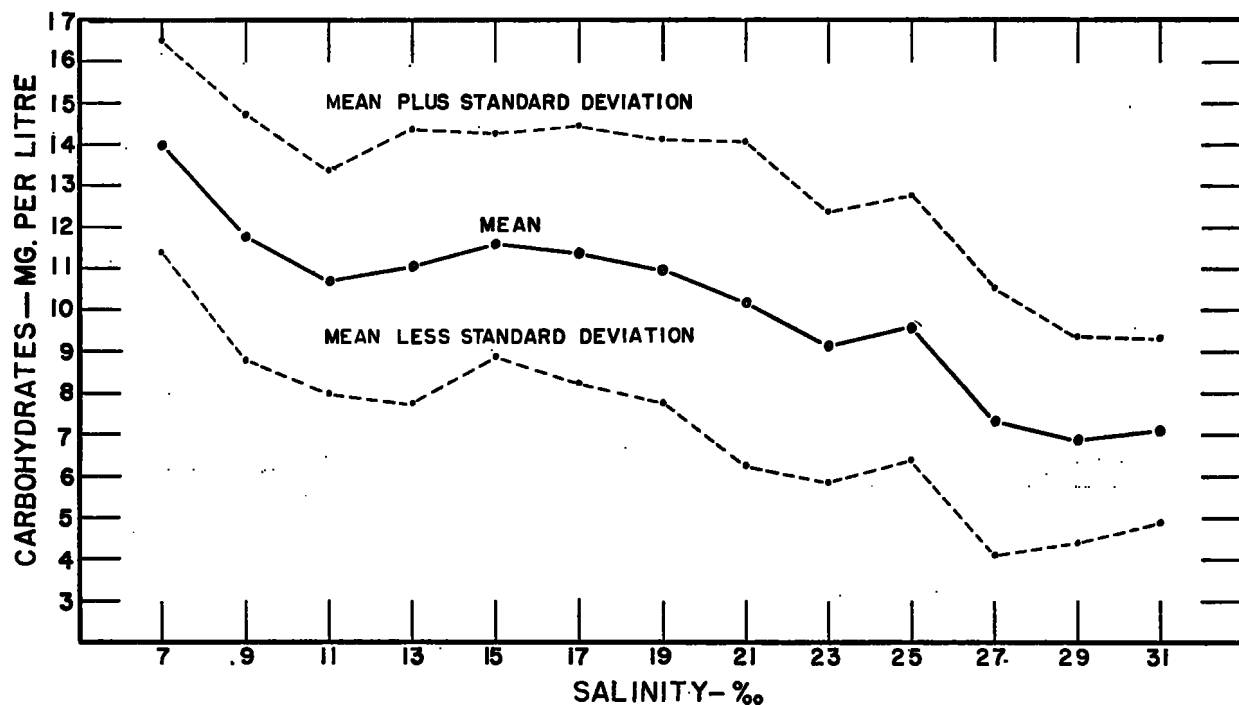

FIGURE 2.—Relation between carbohydrate concentration and salinity. The limits of the mean, plus and minus one standard deviation, are shown.

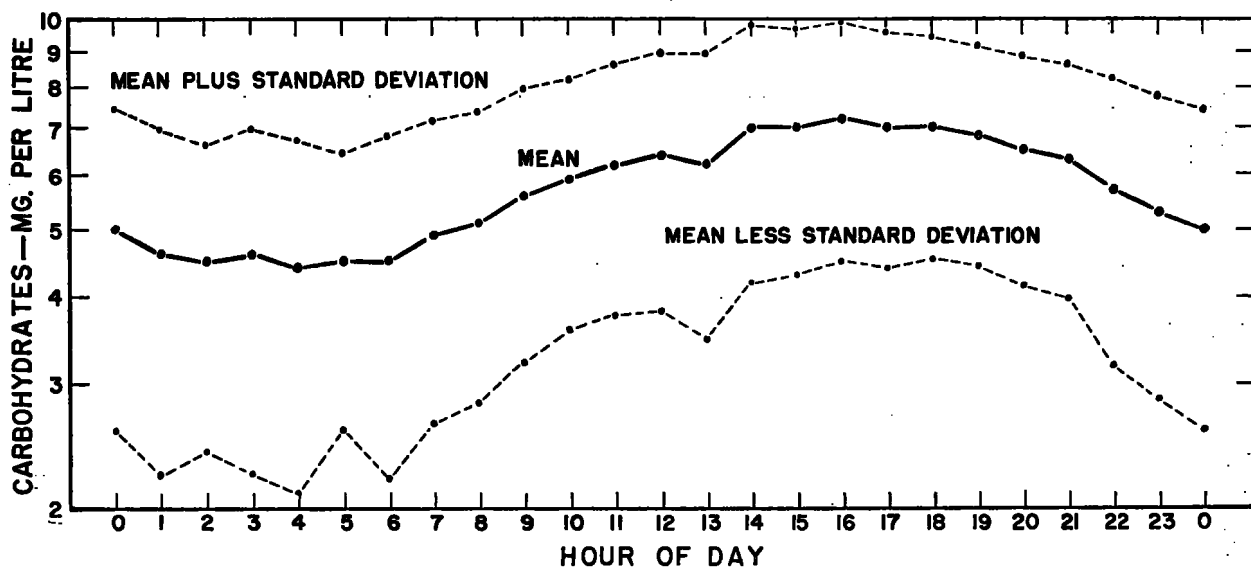

FIGURE 3.—Average diurnal variation in carbohydrate concentration for the period November 13, 1949, to May 30, 1950, plotted on semilogarithmic scale.

DIURNAL VARIATION

A distinct diurnal variation became evident when the logarithms of the carbohydrate concentrations were plotted against the hour of day for the period from November 13, 1949, (when the observations were increased from bihourly to hourly) until May 30, 1950. This cycle was evident whether the data were averaged monthly or for the entire period. The data of averages for the

entire period are shown in figure 3; also plotted are the standard deviations computed at each hour.

From the curve (fig. 3) it is apparent that the concentration reaches a minimum at about 02^h00^m where it remains until about 14^h00^m; it then increases steadily to a maximum at 11^h00^m. This maximum is maintained until 18^h00^m, when the concentration begins a nocturnal decline.

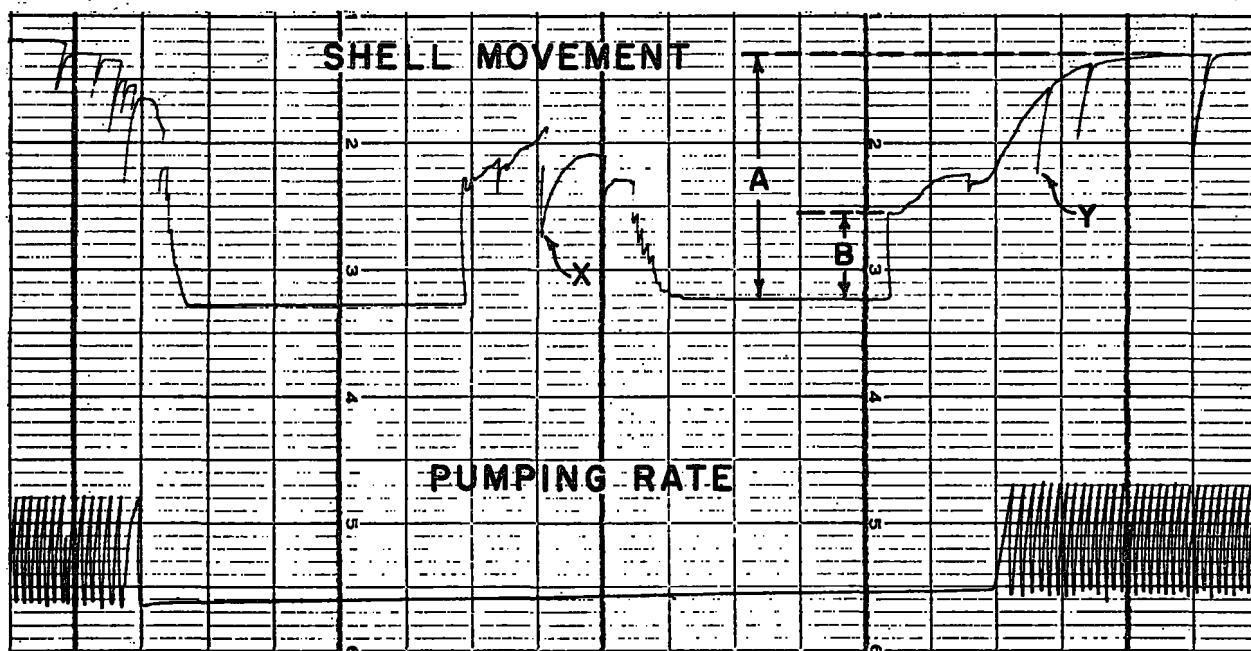
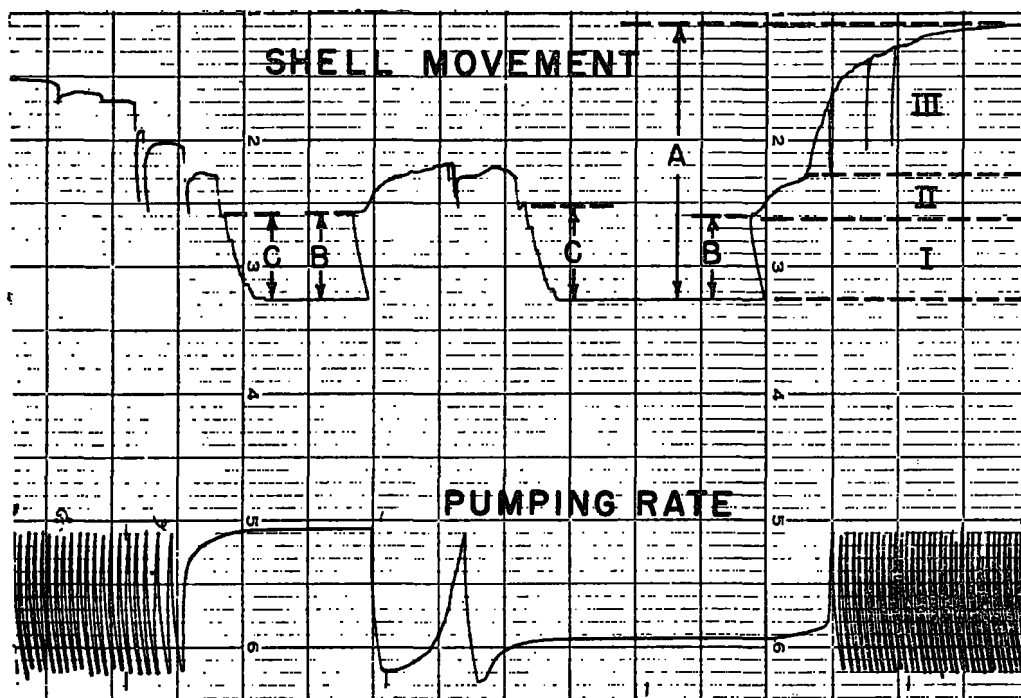

FIGURE 4.—Reproductions of actual records of shell gape and pumping rates, demonstrating the basic components of the shell movements of oysters. In each, *A* indicates the full amplitude of gape, *B* the opening movement of phase I, *C* the closing movement, which is always done in "steps." Lower figure shows two additional types of closures: *X* an abnormal one resulting from mechanical disturbance, *Y* a typical snap closure, probably to eliminate unwanted substances. Paper speed 2 inches an hour; vertical lines represent quarter-hour intervals.

THE OYSTER'S RESPONSE TO CARBOHYDRATES ANALYSIS OF SHELL MOVEMENTS

In analyzing the activity of oysters, as shown earlier, it is necessary to consider separately shell movements and pumping rates. First, we have attempted to isolate and define the elements of the relaxation and contraction of the adductor muscle as reflected by recorded shell movements so as to relate oyster activity to carbohydrates.

Figure 4 illustrates representative shell movements. *A* represents the full gape of the oyster as recorded by the apparatus. This range of "openness," or gape, can be divided into three levels, or phases, which we designate as phases I, II, and III. Each phase has its physiological significance.

We interpret phase I as resulting from the activity of a single, special set of muscle fibers. It is characteristic of these fibers that they relax "all or none," and thus cause the almost instantaneous gape as typified by *B*. Notice that this set of fibers does not close the valves with a single sweep but in steps which have been designated as "treppe" (Galtsoff 1946). It is apparent that there is a distinct mechanism involved in this phase of shell movement. This phase is characterized, both opening and closing, by a more rapid response to external stimuli than are phases II and III.

We believe that phase II must be regarded as a delayed phase III, since it is a transition between

phases I and III. This phase represents a testing period, and probably involves only the proximal and cloacal passages, since the oyster rarely will pass more than 6 or 7 liters of water an hour during this phase. It is probable that the musculature involved is the same as in phase III, but that there is a repressor mechanism which delays progress into phase III until certain environmental requirements are satisfied. Normally an oyster will not remain long in this phase. Figure 4 makes clear why we refer to any opening not going beyond phase II as a testing period.

In phase III, an oyster attains maximum gape and pumps the maximum amount of water. The pumping rate varies with conditions, so that it is essential to record both effluent and shell movement. Phase III, then, represents the full degree of valvular gape which under ideal conditions continues except for certain anomalies. This portion of the curve is broken at various intervals with partial closures indicated in figure 4 (lower) as *Y*. These anomalous closures might be termed "expulsion," or "snap," movements of the valves, probably to void accumulations of inert solids or irritating substances. These snap closures do not normally enter the zone of phase II, but when they do, the rate of reopening is much slower than when they do not. In figure 4 (lower), *X* indicates an abnormal closure resulting from a mechanical disturbance to the oyster. Note that the reopening is much slower than from the *Y* closure.

Each of the three phases has associated with it

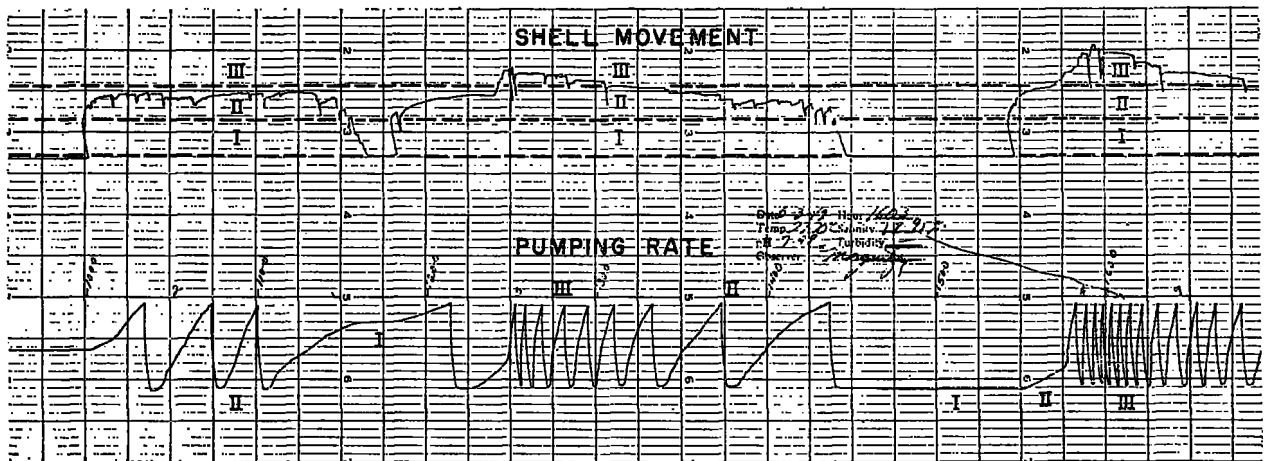

FIGURE 5.—The basic components of shell movements of oysters and their relation to pumping rates. Each cycle of the measuring box represents a minimum of 500 milliliters; the Roman numerals on the pumping rate curve correspond to the three phases demonstrated. Reproduction of actual record. Paper speed 2 inches an hour; vertical lines represent quarter-hour intervals.

definite characteristics of flow through the branchial system (here we arbitrarily include the promyal passage). Phase I may permit a slight flow or none at all; phase II involves some flow, although much less than does phase III. The relation between these phases and their respective pumping rates are typified in figure 5, which is a reproduction of an actual record showing rates of pumping in each of the three phases.

EFFECT OF CARBOHYDRATES ON PUMPING RATE

In these experiments the carbohydrate concentration in the laboratory sea-water supply varied widely. Variations over the entire range within a few hours were common; often variations were 100 percent within 2 hours. Such extreme variation precluded the use of averages in analyzing the data relating carbohydrate concentration to pumping rate.

The hourly effluents, therefore, were computed from pumping rates measured at the time the carbohydrate concentrations were measured. Samples for these carbohydrate determinations were taken from the inhalant side of the oyster,

not from the sampling wheel (see Appendix, p. 183), which was located at some distance from the oyster. Over a long period of time using a number of oysters, we have found a positive correlation between the carbohydrate concentration and the pumping rate of the oyster, as shown in figure 6.

An interesting phenomenon, observed in the detailed study of the oyster's response to carbohydrates, is the testing period, illustrated in figure 7. Variation of the carbohydrate concentration at a temperature of approximately 25° C. is illustrated in the upper figure. Until 10⁰⁰am, the carbohydrate concentration was about 6 mg./l., followed by a rise within 2 hours to the 10 mg./l. level. At the beginning of the interval marked *A* the valves opened into phase II, during which period a small amount of water was passed through the oyster. At this temperature the carbohydrate level was too low to stimulate the oyster to further activity. After a short period of closure, another test was made at interval *B*. Within 30 minutes, the concentration of carbohydrates having risen while the valves were still in phase II, progress into phase III was induced as shown in intervals *C* and *D*. Similarly, but at

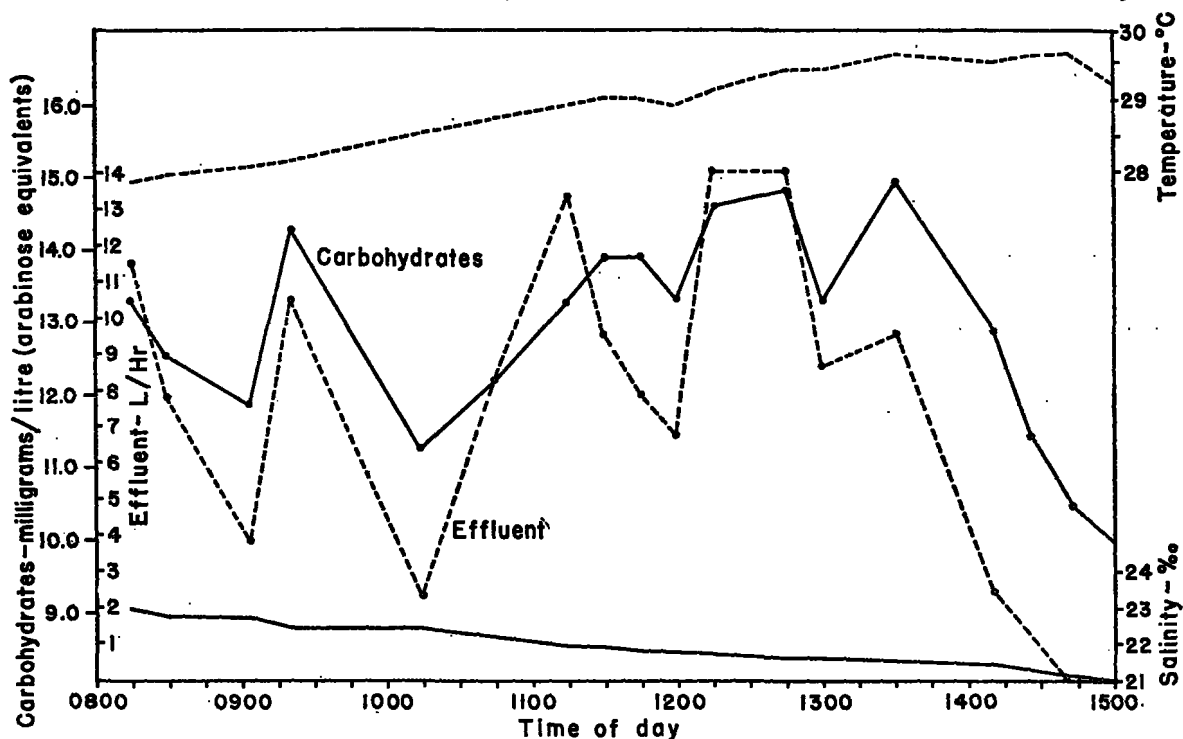

FIGURE 6.—Relation between pumping rates and carbohydrate concentrations. The pumping rates were determined at the moment the carbohydrate samples were taken. The mean carbohydrate concentration is 13.4, and the mean pumping rate 9.15 liters per hour. The correlation coefficient, 0.78, is significant at the 1-percent level.

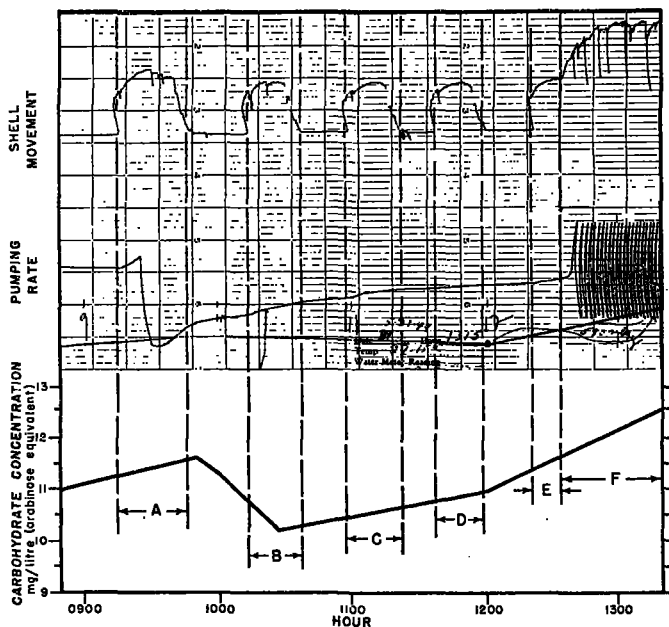
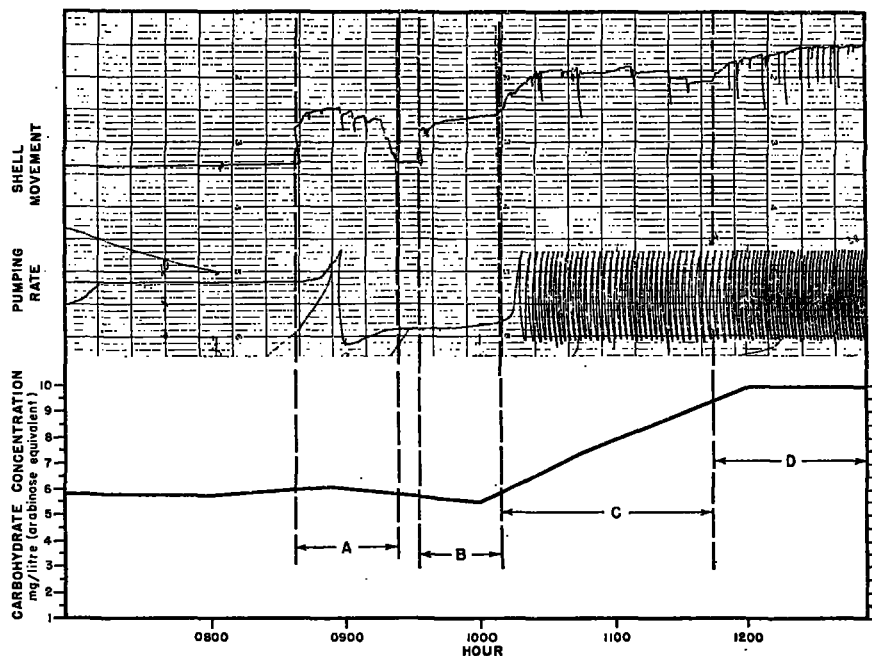

FIGURE 7.—Relation between activity of oysters and variations in carbohydrate concentrations at two temperature ranges. Upper figure at temperatures approximating 25°C ., lower figure approximating 27°C .; salinity ranges 17 $\%$ to 20 $\%$. The carbohydrate threshold for the oyster at 25°C . (upper figure) apparently approximates 6 mg./l. Testing periods are shown as intervals A and B, phase III as C and D. Lower figure (27°C .) shows four similar testing periods A, B, C, and D; on the fifth test, E, the carbohydrate concentration had increased sufficiently to induce phase-III pumping, interval F. This oyster, at the higher temperature, apparently had a much higher threshold level (approximating 12 mg./l.) than that of the oyster at 25°C . Reproductions of actual records. Paper speed 2 inches an hour; vertical lines at quarter-hour intervals.

an increased carbohydrate concentration because of increased temperature, the oyster recorded in the lower figure went from phase II into phase III at interval *E*, following four unfavorable testing periods *A* through *D*.

The association of increased pumping rate with a threshold level of carbohydrate concentration and the effect of increasing temperatures on this threshold level are obvious.

Having demonstrated the instantaneous pumping-rate response of the oyster to changing concentrations of carbohydrates, we examined the records of cumulative hourly pumping-rate responses to these changes. Figure 8 showing on a semilog scale the reaction of a typical oyster (No. 92), and of five oysters combined, to the

changes in carbohydrate concentration, makes it evident that despite the stated limitations of this method to measuring the carbohydrate activity ratio, the relative changes in hourly effluents do parallel very closely the relative changes in carbohydrate concentrations. The low effluent rate preceding 18⁰⁰m on January 27 is coincident with phase-II pumping, and occurs with the carbohydrate concentrations below the threshold level for that temperature. With the rise in carbohydrate concentration above the threshold, the pumping rate increases to that of phase III.

Figure 9 illustrates, on a semilog scale, the relation of the average-cumulative-daily effluent to average-daily level of carbohydrate concentration, based on records of two to four oysters

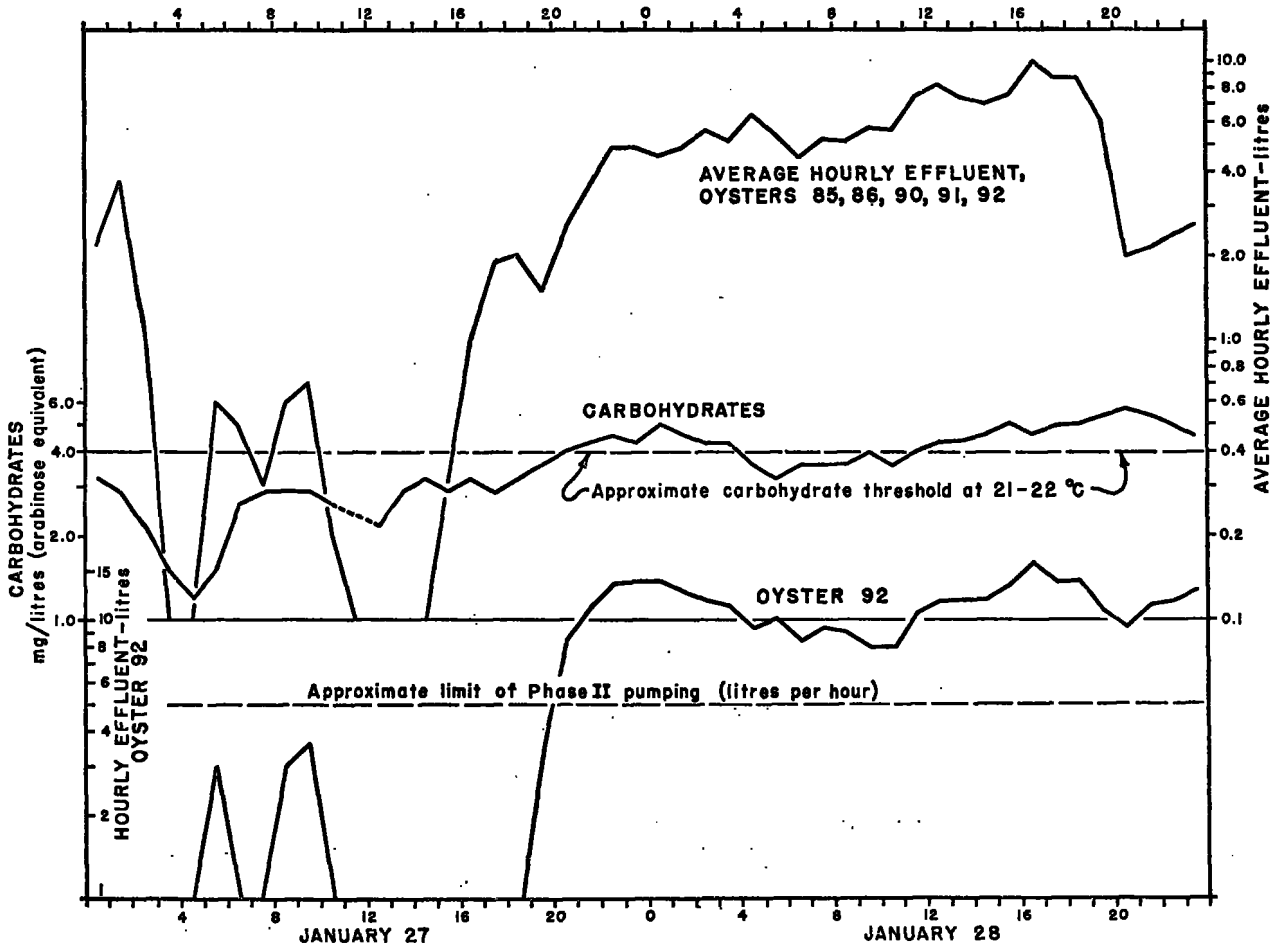

FIGURE 8.—The relation between carbohydrates and cumulative-hourly effluents over a 2-day period, plotted on semilog scale. The curve for an individual oyster is shown, together with the average values for all the oysters being recorded during the same period. In each case the hourly effluent went above the phase-II level when the carbohydrates went above 4 mg./l. During the twentieth hour of January 28, an external factor interfered. The oysters responded, but had begun to recover at the close of the period

available through a 30-day period. This comparison was made, despite its recognized limitation, to establish the relation over a long period. It is quite evident from an examination of this figure that such a definite relation does exist.

Figures 10 and 11 illustrate the relation that exists between carbohydrates and temperature as factors influencing the average pumping rate. Figure 10 is based on two defined temperature ranges, while figure 11 is based on a division according to season, i. e., the warm months, May 10 to November 13, and the cold months, November 13 to January 31, of the northern coast of the Gulf of Mexico.

It is apparent that water temperature above 25° C. are unfavorable for oysters in regions in

which the production of the dissolved carbohydrates is low.

ASSIMILATION OF CARBOHYDRATES

The oysters can and do remove variable quantities of carbohydrates from the water. This has been ascertained by determining the amount of carbohydrate in the water before it enters the valves of the oyster and after it has passed through the body. The quantities removed do not seem to be related to any of the other measurable activities of the oyster, and, of course, the results could be affected by the oyster's waste metabolites, which are present in the exhalant water. The data of table 2 indicate that up to 50 mg./hour are removed. This is a significant quantity of such material, and assuming that all is utilized,

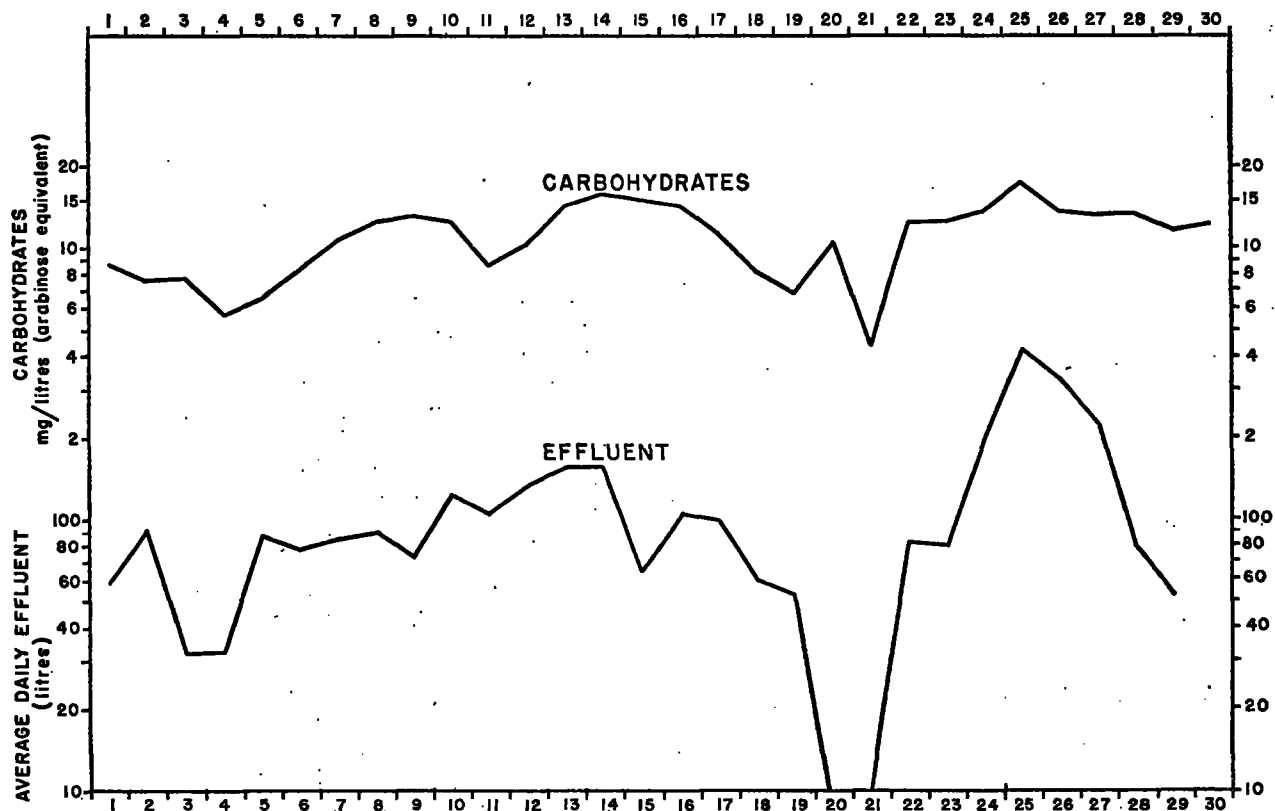

FIGURE 9.—Relation between carbohydrates and average-cumulative-daily effluents of two to four oysters over a 30-day period, June 1–30, 1949, plotted on a semilog scale. While data from four oysters were combined in establishing this curve, mechanical difficulties reduced the number to two during part of the time.

it represents an oxygen consumption³ of approximately 50 mg./hour. Yonge (1928), in performing experiments on the mode of utilization of dissolved glucose, found that European oysters (*Ostrea edulis*) removed approximately 20 mg./hour. He felt that the removal took place in the stomach, and earlier (1926) had concluded that there was no evidence of any enzymes free in the gill mucus. This latter would not be necessary if the substance in question were adsorbed on the mucous train and carried into the alimentary tract.

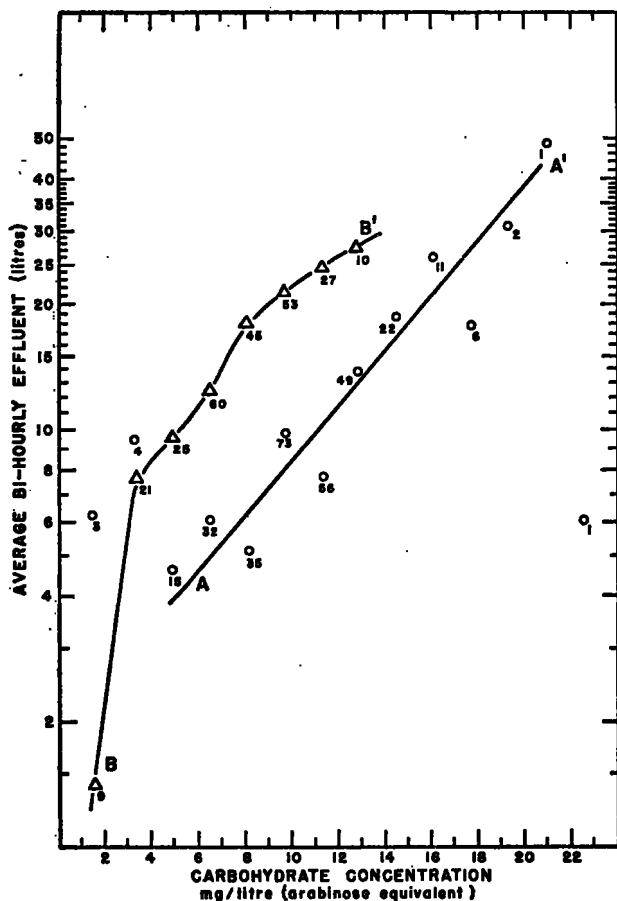

FIGURE 10.—The shift in the carbohydrate-pumpage relation due to temperature. The values are derived from the simultaneous observation of temperature, carbohydrate concentration, and bihourly effluent. Curve A-A' is for the temperature range 25° to 30° C., inclusive; curve B-B' is for 14° to 21° C., inclusive. The temperatures shifted from one range to the other so quickly that there were insufficient frequencies for analysis in the 22.0° to 24.9° C. bracket. The small figures at each point represent the number of samples from which the value is derived.

³ According to our later studies (Collier, Ray, and Magnitzky, manuscript in preparation), the oyster actually does utilize oxygen on a scale commensurate with this figure.

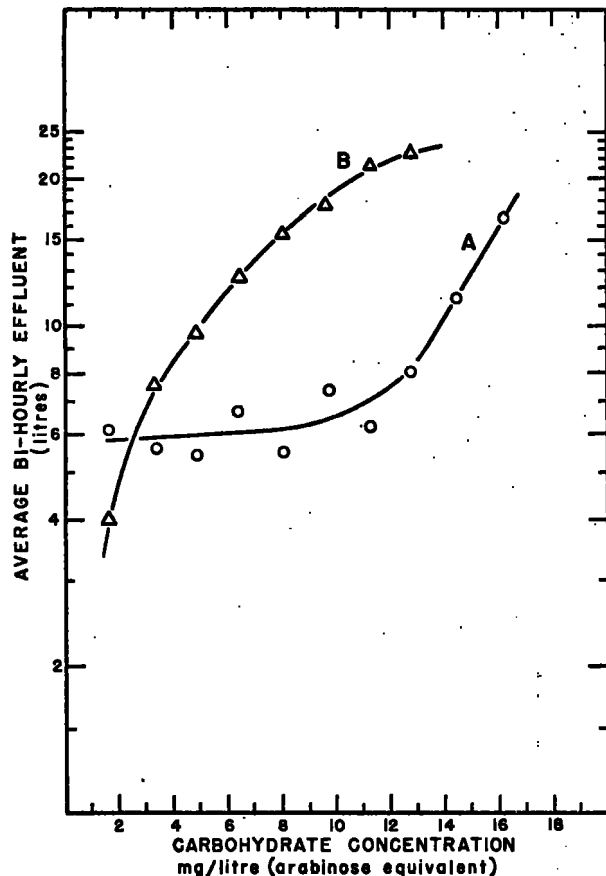

FIGURE 11.—Relation between carbohydrate concentration and the bihourly effluent of oysters. Curve A is derived from 3,891 bihourly observations on 12 oysters from May 10, 1949, to November 13, 1949. The flat portion of the curve represents the dominance of phase-II pumping (testing periods) at carbohydrate values of less than 12 mg./l. during the warm months. Curve B is derived from 5,464 hourly observations on 11 oysters for a period of winter temperatures, November 13, 1949, to January 31, 1950. Semilog coordinates.

TABLE 2.—Removal of carbohydrates from sea water by oyster 74, May 24-June 11, 1949

| Pumping rate ¹ | Temperature | Concentration of carbohydrates in sea water | Hourly rate of carbohydrate removal |
|---------------------------|-------------|---------------------------------------------|-------------------------------------|
| L./hr. | ° C. | Mg./l. | Mg. |
| 12.7 | 26.1 | 12.1 | 11.4 |
| 13.9 | 25.9 | 12.1 | 15.3 |
| 17.1 | 26.7 | 7.3 | 13.7 |
| 17.6 | 25.9 | 10.5 | 10.6 |
| 24.4 | 28.4 | 6.6 | 21.7 |
| 24.6 | 25.9 | 11.2 | 24.6 |
| 25.2 | 27.2 | 8.7 | 22.7 |
| 25.2 | 27.2 | 6.3 | 15.7 |
| 25.2 | 28.8 | 11.0 | 50.2 |
| 26.4 | 28.5 | 9.1 | 22.3 |
| 27.9 | 28.0 | 8.2 | 35.2 |
| 29.3 | 27.5 | 10.5 | 16.7 |
| 33.4 | | | |

¹ Some of these values were obtained while the oyster was going from phase I to phase II; therefore, the pumping rates shown do not necessarily reflect the correlation of pumping rate and carbohydrate concentration.

ANOMALOUS RESPONSES

The carbohydrate-temperature relation is not the only factor to which oysters respond. Others are involved, and they must often dominate the oyster's behavior pattern, and conceal the effects of the carbohydrates. As previously stated, it must be recognized that we do not know that the substances indicated as carbohydrates by the test are always true carbohydrates. Further, we cannot say which of the many carbohydrates are responding to the test, nor can we say which of the carbohydrates are represented. There is the possibility that the oyster is responding to a single carbohydrate which varies considerably, but whose variation may be completely hidden by other carbohydrates which may be far more abundant at times. Bell (1948) states that "numerous so-

called glycogens in plants and animals may not be chemically identical with animal glycogens, which may quite well vary among themselves." Since glycogen is one of the carbohydrates, the significance is apparent.

Figure 12 demonstrates an extreme of variation between oysters in their responses to variations in carbohydrate concentrations. Note that oyster 88 was comparatively insensitive to carbohydrate changes during the first few days, especially on December 7. By comparison, oyster 87 was markedly responsive to the material throughout. Despite the anomalies (which may be due to the sampling difficulties previously pointed out), these figures illustrate the influence of consistently low carbohydrate levels, particularly during the winter period.

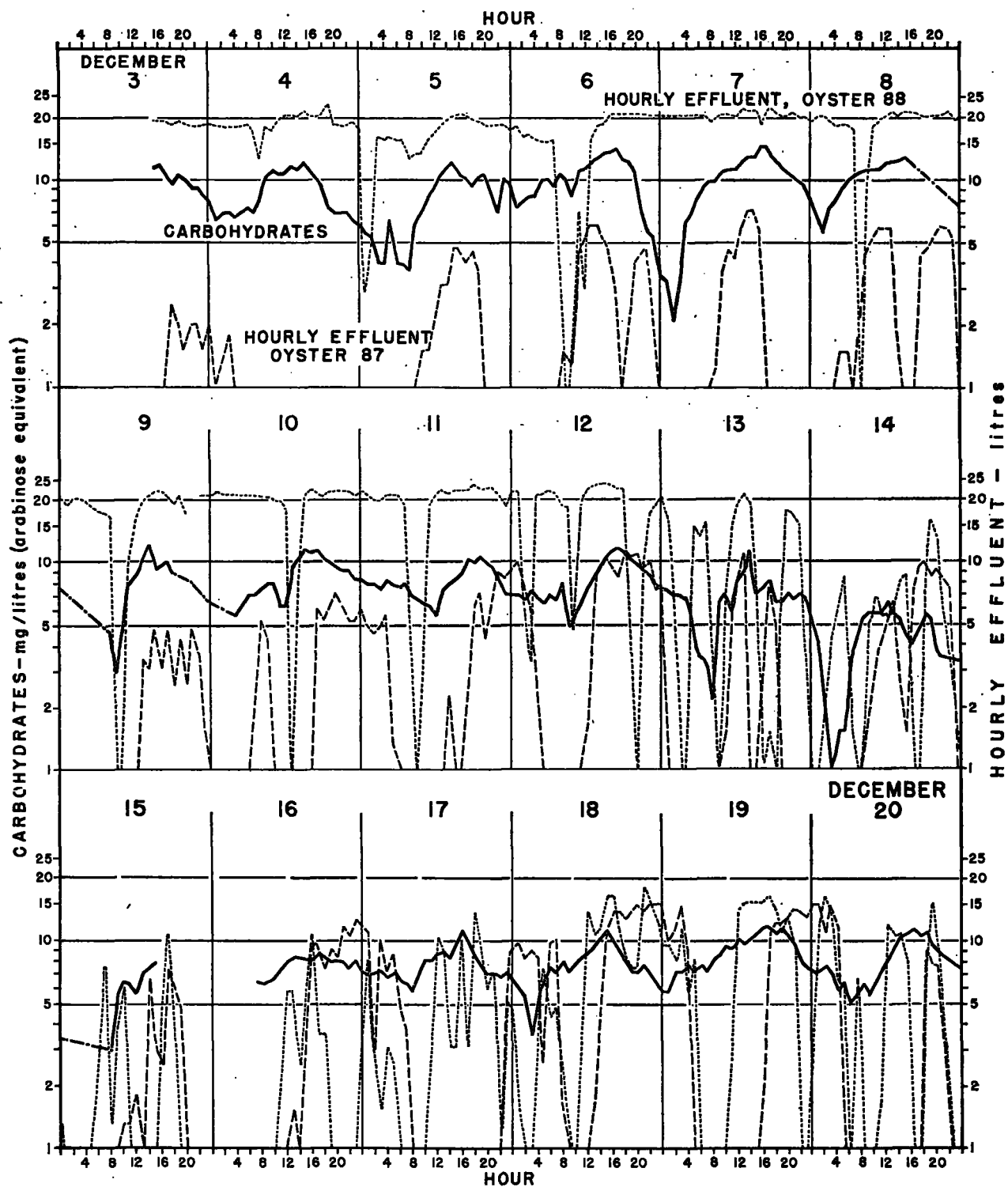

FIGURE 12.—Example of extremes in pumping-rate response of two oysters to a common carbohydrate concentration over an 18-day period plotted on a semilog scale. It is likely that oyster 88 had a glycogen reserve at the start, so was not as dependent on external nutrients as was 87.

SUMMARY

During prolonged and detailed studies of the effects of industrial wastes on oysters, *Crassostrea virginica* (Gmelin) at Pensacola, Fla., we noted that shell gapes and pumping rates of oysters under simultaneous observation behaved in a parallel manner as though responding to a common factor. It was found that this behavior pattern was related to the concentration of certain organic substances dissolved in sea water, and that these substances responded to the N-ethyl-carbazole test for carbohydrates.

The simultaneous recording of shell movements and pumping rates was chosen as the best available index of physiological activity for establishing this relation, since both lend themselves to uninterrupted recording over long periods of time. In analyzing these recordings, it became evident that shell movements and pumping rates are divided into three distinct levels, which we have defined as phases I, II, and III, each with its physiological significance. In phase I, there is an almost instantaneous gape on opening to about one-third of the maximum gape, a less rapid step closure, no pumping, and a rapid response to external stimuli. Phase II, the middle third of the total gape, must be regarded as a transition between phases I and III, represents a testing period, and probably involves only the proctal and cloacal passages, since the oyster rarely passes more than 7 liters of water an hour during this phase. In phase III, the oyster attains maximum gape and pumps the maximum amount of water. Because the pumping rate varies with conditions, it is essential to record both effluent and shell movement in interpreting the effects of varying concentrations of the dissolved carbohydrates. Certain anomalies within these phases were noted, including snap closures while in phase III. These closures usually do not enter phase II, but when they do, the rate of reopening is retarded.

An association between carbohydrate concentration and salinity was noted, but the significance of this relation remains obscure. It could be the result of physical dilution of carbohydrate-rich low-salinity inshore water with carbohydrate-poor high-salinity gulf water, or of the adverse effect of high-salinity water on the growth of the organisms creating the carbohydrates.

It was established that the oysters remove

variable quantities (up to 50 mg./hour) of the carbohydrates from sea water.

Considerable variation in the response of individual oysters to the carbohydrates were noted. This would be expected, since the carbohydrate/temperature factor is not the only one to which oysters respond, and these other factors must often dominate the oyster's behavior pattern, concealing the effects of the carbohydrates. Then, too, the substances which respond to the N-ethyl-carbazole test may not all be true carbohydrates, or the oyster may be responding to only certain of the carbohydrates within the carbohydrate complex, whereas the test responds to all.

The concentration of dissolved carbohydrates was found to vary widely in the sea-water supply. Because of this, the relation of carbohydrate concentration to pumping rate becomes obscure unless the pumping rate and carbohydrate concentration were measured simultaneously. A definite response of the oyster in the phase of opening and in the rate of pumping to the carbohydrate concentration was noted. Each oyster appears to have a threshold limit to the carbohydrates below which it will not pump. This threshold is raised with increasing temperatures. A correlation of 0.78, significant at the 1-percent level, was established over a long period of time using a number of oysters when the pumping rate and carbohydrate concentrations were measured simultaneously. Even when average-cumulative-daily effluents and average-daily-carbohydrate levels were compared, the relation between the two was striking. Because of the raising of the threshold level with increasing temperatures, it is apparent that water temperatures above 25° C. are unfavorable for oysters in regions in which the carbohydrate concentration is low.

During the course of these observations certain characteristics of these carbohydrates were investigated. It was established that no significant changes in concentration took place when held overnight either in the refrigerator or at room temperature; that the concentration first increased, and later decreased when exposed to daylight for prolonged periods; that this increase was affected by aeration; that, when filtered or centrifuged, or when held in the dark, no significant change in concentration took place. From these findings it became evident that the carbohydrates result from biotic activity.

LITERATURE CITED

- BELL, D. J.
1948. The structure of glycogens. *Biol. Rev. Cambridge Philos. Soc.*, vol. 23, pp. 256-266.
- COLLIER, ALBERT, and SAMMY M. RAY.
1948. An automatic proportioning apparatus for experimental study of the effects of chemical solutions on aquatic animals. *Science*, vol. 107, pp. 576-577.
- COLLIER, ALBERT, SAMMY M. RAY, and WAYNE MAGNITZKY.
1950. A preliminary note on naturally occurring organic substances in sea water affecting the feeding of oysters. *Science*, vol. 111, pp. 151-152.
- DISCHE, ZACHARIAS.
1927. Über Charakteristische Farbreaktionen der Milchsäure des Methylglyoxals und der Kohlehydrate mit Carbozal und Schwefelsäure. *Biochem. Zeitschrift*, vol. 189, pp. 77-80.
- ERDMAN, J. GORDON, and AUGUSTA B. LITTLE.
1950. Special report on the analysis of marine coastal and estuarial waters. Mellon Institute of Industrial Research, University of Pittsburgh. May 1950. 50 figs.
- GALTSOFF, PAUL S.
1926. New methods to measure the rate of flow produced by the gills of oysters and other Mollusca. *Science*, new series, vol. 63, No. 1626, pp. 233-234.
1928a. Experimental study of the function of the oyster gills and its bearing on the problems of oyster culture and sanitary control of the oyster industry. *Bull. United States Bur. Fish.*, vol. 44, pp. 1-39.
1928b. The effect of temperature on the mechanical activity of the gills of the oyster (*Ostrea virginica*, Gmelin). *Jour. Gen. Physiol.*, vol. 11, pp. 415-431.
1946. Reaction of oysters to chlorination. United States Fish and Wildlife Service, Research Rept. 11.
- GALTSOFF, PAUL S., HERBERT F. PRYTHORCH, ROBERT O. SMITH, and VERA KOEHRING.
1935. Effects of crude oil pollution on oysters in Louisiana waters. *Bull. United States Bur. Fish.*, vol. 48, pp. 143-210.
- KORRINGA, P.
1949. More light upon the problem of the oyster's nutrition? *Bijdragen Tot de Dierkunde*, vol. 28, pp. 237-248.
- MOORE, H. F.
1908. Volumetric studies of the food and feeding of oysters. *Bull. United States Bur. Fish.*, vol. 23, pp. 1297-1308, 1 table, 6 figs., 1 pl.
- NELSON, THURLOW C.
1936. Water filtration by the oyster and a new hormone effect upon the rate of flow. *Proc. Soc. Exp. Biol. and Med.*, vol. 34, pp. 189-190.
- YONGE, C. M.
1926. Structure and physiology of the organs of feeding and digestion in *Ostrea edulis*. *Jour. Mar. Biol. Assoc.*, new series, vol. 14, p. 2.
1928. The absorption of glucose by *Ostrea edulis*. *Jour. Mar. Biol. Assn.*, new series, vol. 15, pp. 643-653 (*rev. Jour. du Conseil*, vol. 4, p. 124).

APPENDIX

ESTIMATING CARBOHYDRATES IN SEA WATER

The test for carbohydrates was developed by Dische (1927) with adaptations to suit our requirements by Erdman, who found that N-ethyl-carbazole ($C_{12}H_9NC_2H_5$) was better suited for work with sea water than carbazole (Erdman and Little 1950). Further modifications were made for the particular type of electrophotometer (Fisher AC) used. All photometer readings were made with a green filter which bracketed the range of the peak absorptions of the dyes resulting from the use of the N-ethyl-carbazole reagent.

The reagent was prepared by dissolving 250 mg. of N-ethyl-carbazole in 250 ml. of prechilled 90-percent sulfuric acid (reagent grade ¹). It was made up in quantities to last not more than 48 hours and stored in the refrigerator. Use of distilled tapwater sometimes resulted in the development of a green color in the reagent, but distilled rainwater eliminated this difficulty. The tapwater was Mississippi River water from a small sedimentation and chlorinating plant. No explanation is offered for this reaction, but it is mentioned as a precaution to any who might apply the test. All glassware, including reagent bottles, should be thoroughly seasoned in sulfuric acid before being used.

Exposed to direct sunlight, the reagent will turn green and become valueless in approximately 5 minutes. It should be mixed in subdued light and stored in the dark.

In many cases where there is no carbohydrate present in the water the reaction will develop into deep green. In deep ocean waters this color has been found to be associated with high nitrate values; but if carbohydrates are present with the nitrates, the deep green will not develop.

The routine procedure was as follows: (1) The seawater sample was centrifuged for 10 minutes at a relative centrifugal force of 336. (2) A 2.5-ml. sample was drawn by pipette from the top of the centrifuged sample and put in a 25-ml. tube with 22.5 ml. of N-ethyl-carbazole reagent and hydrolyzed for 15 minutes at 70° C. ± 0.5° C. A small chip of lint- and paper-free paraffin was dropped on the surface to exclude oxygen. (3) After hydrolysis, the sample was cooled for

¹ Acid supplied in bottles with seals of cellulose derivatives was contaminated by them and was made unsuitable for this test.

15 to 25 minutes and transferred to a 23-ml. cuvette. The color density was measured and recorded as $-\log T$.

The densities thus determined were converted to equivalent arabinose in milligrams-per-liter by the use of a graph constructed from standard dilutions of l-arabinose. The general precautions pertaining to colorimetry were observed throughout. The data for a set of standards are presented in table A-1. The l-arabinose was checked for adsorption of atmospheric moisture by a series of weighings made over a period of 20 minutes at 5-minute intervals. No increase in weight was detectable on the analytical balance.

TABLE A-1.—($-\log T$) values for various concentrations of l-arabinose

| Test | 1.03 mg. l-arabinose per liter | 10.30 mg. l-arabinose per liter | 20.60 mg. l-arabinose per liter | 51.50 l-arabinose per liter |
|-------------|--------------------------------|---------------------------------|---------------------------------|-----------------------------|
| No. 1..... | 2.5 | 15.5 | 30.0 | 74.0 |
| No. 2..... | 2.5 | 15.5 | 31.0 | 74.5 |
| No. 3..... | 2.0 | 15.0 | 30.0 | 74.0 |
| No. 4..... | 2.5 | 16.0 | 30.5 | 74.0 |
| No. 5..... | 2.0 | 15.5 | 30.0 | 74.0 |
| No. 6..... | 2.0 | 15.5 | 30.0 | 73.5 |
| No. 7..... | 2.5 | 15.0 | 30.0 | 74.0 |
| No. 8..... | 2.5 | 15.5 | 29.5 | 74.0 |
| No. 9..... | 2.0 | 16.0 | 30.0 | 74.0 |
| No. 10..... | 2.0 | 15.5 | 30.0 | 74.0 |

MEASURING OYSTER ACTIVITY

The principles of the rubber apron originated by Moore (1908), and the constant-level chamber developed by Galtsoff (1926) were combined in this study to improve the accuracy of measurements of the pumping rate of oysters reported by Nelson (1936).

We found the attachment of the dental dam to the valves of the oyster was done most expediently with a small soldering nail and sticks of beeswax. The soldering nail was connected to a suitable rheostat and the voltage set to keep the soldering nail just at, or slightly over, the melting temperature of the beeswax. The beeswax was worked into small pencils and applied to the shell of the oyster with the point of the soldering nail. First, the wax was applied along the line of attachment of the rubber to fill the irregularities of the shell which could cause leaks. After this, a small wall of wax was built up and the rubber sealed to it. At the hinges and in the region of the pallibrachial

fusion, small pads of pyrex wool (instead of cotton) were used as packing between the rubber membrane and the shell. The glass does not lose its resilience when wet, neither is it subject to organic decay on long exposure to experimental conditions. The oysters were held in position on Hopkin's stands (fig. A-1) and connected to the trough. To determine the amount of effluent, we used a simple box with an automatic siphon in the place of the usual dumping bucket (Collier and Ray 1948).

We acknowledge the great assistance of Drs. W. E. Hanson and J. G. Erdman of the Mellon Institute of Industrial Research, and we are grateful to W. K. Bowman, of the Gulf Research and Development Company, for providing us with excellent electric kymographs built to the specifications of our project. Some of the early records were made with a paper speed of 2 inches an hour, but this was later changed to 4 inches an hour. At the latter speed, we obtained 2 weeks of uninterrupted recording with superior amplification of detail.

DESCRIPTION OF SAMPLING DEVICE

The sampling device (fig. A-2) consisted of a wheel (A) whose circumference revolved under a continuous stream of water (B), and thus caused the equally spaced tubes (C) to be filled. The interval of filling was regulated by the spacing of the tubes and the velocity of the wheel. The wheel was driven by a synchronous motor (D) whose velocity was 1 revolution in 24 hours.

The wheel was fastened to a vertical shaft by means of a flange; the shaft was suspended at (E) by means of a thrust bearing and set collar, and was connected to the drive shaft of the motor by a tubular coupling. In this manner, exposure of the motor and bearing suspension to salt water was minimized.

The waste water overflowed onto absorbent material, and this, in combination with the tight lid, kept the atmosphere within the chamber saturated. Evaporation was not sufficient to affect the accuracy required ($\pm 0.05\%$) for salinity determinations.

The apparatus as used by us gave a 15-minute composite sample every 1 or every 2 hours, as desired.

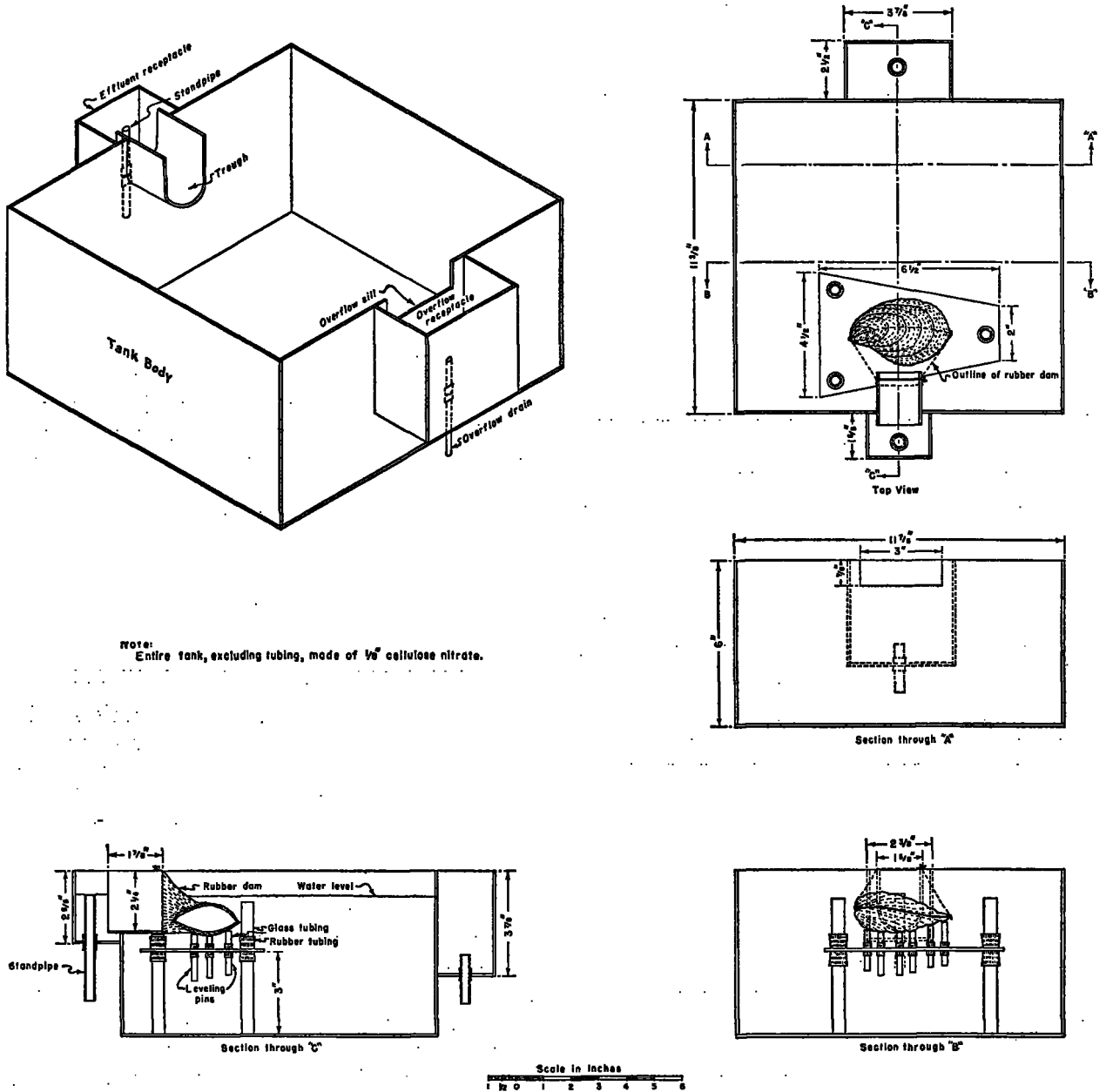

Note:
Entire tank, excluding tubing, made of 1/8 cellulose nitrate.

EXPERIMENTAL TANK USED IN MEASURING PUMPING RATE OF OYSTERS

FIGURE A-1.—Tank used in the experimental study of oysters. The oyster is fastened to the Hopkin's stand with beeswax at the ends of the small glass tubes. The water level at the top of the standpipe is finely adjusted so as to break over with the addition of two or three drops of water, yet not back the water into the tank body. The tube is cut with a carborundum saw and, once set up, it is never allowed to become dry, because the wetting property of the bacterial slime which accumulates there would be destroyed and the "sensitivity" of the tube lost.

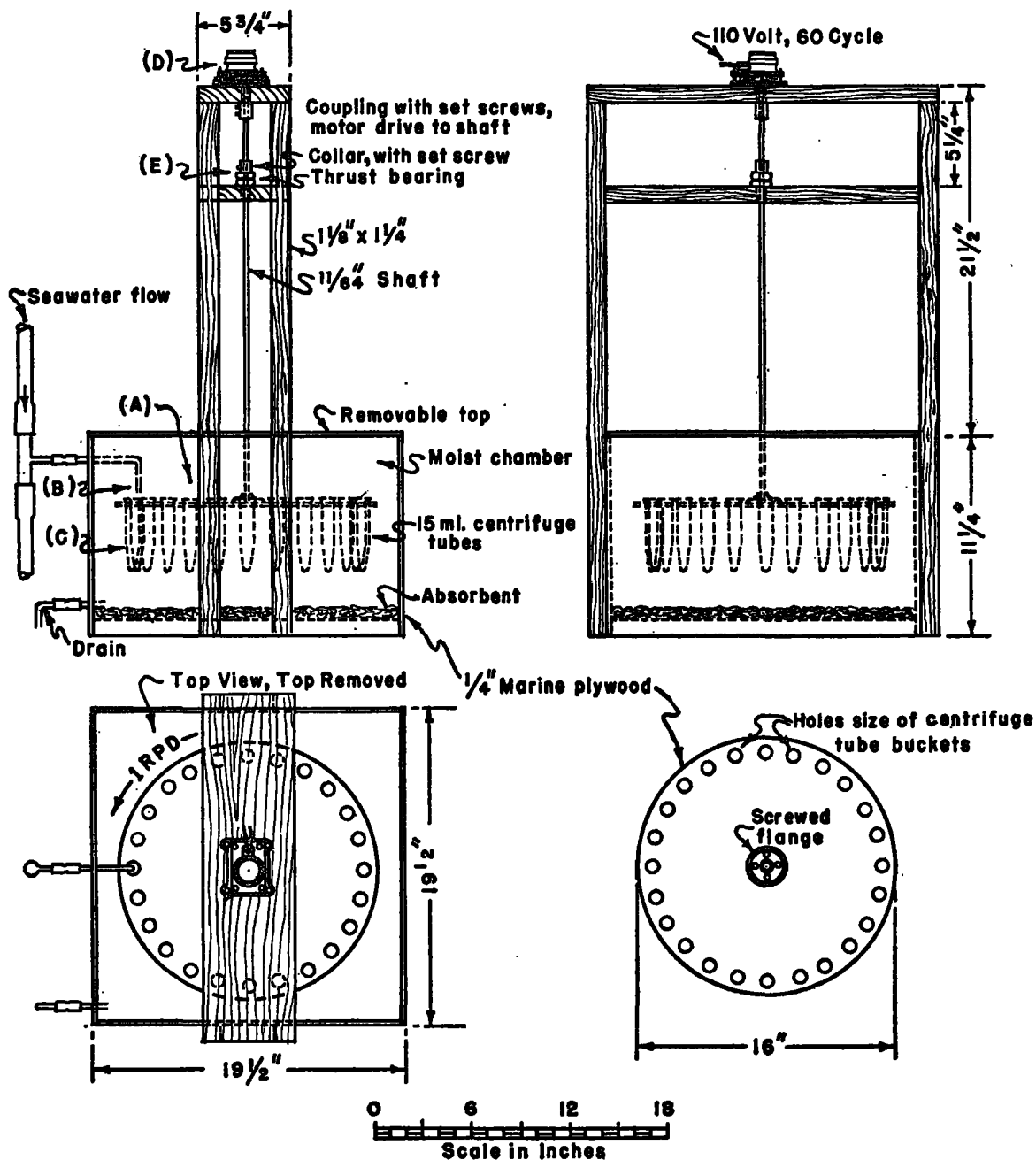

FIGURE A-2.—Device for automatically sampling water at hourly intervals. Operated by a synchronous motor, it was so designed as to rotate one of the 24 tubes under the inflow pipe each hour.