

OCEAN DISTRIBUTION, GROWTH, AND EFFECTS OF THE TROLL FISHERY ON YIELD OF FALL CHINOOK SALMON FROM COLUMBIA RIVER HATCHERIES

KENNETH A. HENRY¹

ABSTRACT

Data are presented depicting the distribution of some stocks of Columbia River hatchery fall chinook salmon in the northeast Pacific Ocean. These are based on recoveries of marked fish. Also presented are the apparent growth histories for fish from the Kalama and Spring Creek Hatcheries as well as a graphic population model for Columbia River fall chinook salmon. Finally, the effect on total yield for varying troll fishing mortalities for the 3-, 4-, and 5-year-old fish is analyzed and the results depicted in three-dimensional yield diagrams. In most instances, at least at the lower levels of estimated natural mortality, troll fishing of the younger fish reduced total yield.

A cooperative program was undertaken between the various fishery agencies in the United States and Canada to estimate the contributions to various fisheries of fall chinook salmon (*Oncorhynchus tshawytscha*) produced by a number of Columbia River hatcheries. Approximately 10% of the output from 12 hatcheries for the brood years 1961-64 was marked by the removal of certain fins. The design of this experiment, including a detailed account of the procedures used in calculating the number of marked fish recovered, and details of mark recoveries for the 1961 brood have been reported by Worlund, Wahle, and Zimmer (1969). Details of mark recoveries for the 1962 and 1963 broods were given by Rose and Arp (1970)² and by Arp et al. (1970)³, respectively. Cleaver (1969) made a detailed analysis

of the 1961 brood based on mark recoveries. His analysis included estimating ocean mortality rates, maturity schedules, and, for the Spring Creek and Kalama fish, the effect of no ocean fishing on total yield. Henry (1971) made a similar analysis for the 1962 brood and, wherever possible, compared the results with those obtained for the 1961 brood. The general release and recovery areas covered by this marking program are shown in Figure 1.

Although a total of 12 hatcheries was involved in this study, fish from only two hatcheries, Spring Creek and Kalama, received specific identifying marks for all 4 years. Each year fish from two of the other ten participating hatcheries (but two different ones each year) also received special identifying marks. In addition to specific marks for four hatcheries each year, a certain proportion of the output from all participating hatcheries had a common mark. This mark — that is a composite of all the hatcheries — is referred to as the general mark. Thus, it is possible for only Spring Creek, Kalama, and general mark fish to analyze mark recoveries from all four brood years.

In the report, I have analyzed the mark recoveries for Spring Creek, Kalama River, and general marked Columbia River hatchery fall chinook salmon from the four consecutive brood

¹ National Marine Fisheries Service Northwest Fisheries Center, 2725 Montlake Boulevard East, Seattle, WA 98102.

² Rose, J. H., and A. H. Arp. 1970. Contribution of Columbia River hatcheries to harvest of 1962 brood fall chinook salmon (*Oncorhynchus tshawytscha*). Bur. Commer. Fish., Columbia Fish. Program Off., Appraisal Section, Portland, Oreg. 27 p. (processed).

³ Arp, A. H., J. H. Rose, and S. K. Olhausen. 1970. Contribution of Columbia River hatcheries to harvest of 1962 brood fall chinook salmon (*Oncorhynchus tshawytscha*). U.S. Dep. Commer., Natl. Oceanic Atmos. Admin., Natl. Mar. Fish. Serv., Columbia Fish. Program Off., Portland, Oreg., Econ. Feasibility Rep. 1. 33 p. (processed).

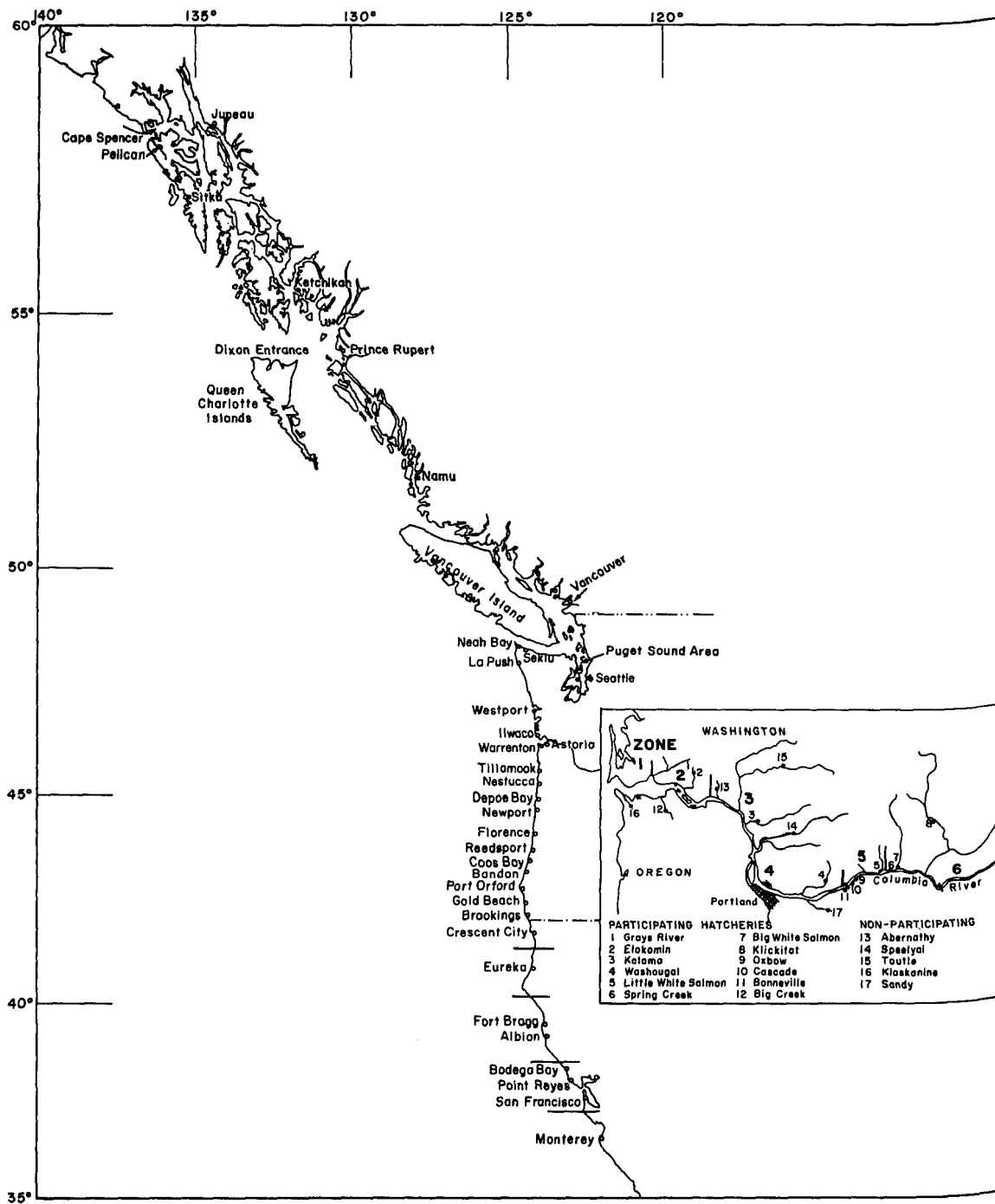

FIGURE 1.—Sampling areas in marine fisheries and release locations (inset) for the Columbia River hatchery evaluation program (from Lander, 1970).

years (1961, 1962, 1963, and 1964). I have demonstrated some of the differences in ocean distribution, contributions to various fisheries, and growth that occur between hatcheries—even within hatcheries—for different brood years. I also have presented a graphic population model for Columbia River fall chinook salmon. This model depicts all the factors affecting these stocks of salmon throughout their life history. Finally, within the general framework of the mortality estimates developed for the 1961 brood (Cleaver, 1969) and 1962 brood (Henry, 1971), I have analyzed the portion of the population model pertaining to the commercial fisheries to determine the overall effect on total yield for varying levels of ocean troll fishing mortalities on the 3-, 4-, and 5-year old fish.

RECOVERIES BY AREA

The ocean distribution of mark recoveries and contributions to the various fisheries was quite different for Kalama, Spring Creek, and general marked fish. Pulford (1970) listed the contribution of Columbia river hatchery fall chinook (all hatcheries combined) to the various fisheries along the Pacific Coast for 1966 only. Lander (1970) analyzed the distribution along the coast and contribution to the various fisheries in considerable detail for each hatchery; his data included sampling through 1966 only. In Table 1 are listed the calculated total recoveries by geographical area for the 1961 through 1964 brood years of special marked Kalama and Spring Creek fall chinook salmon and general marked

TABLE 1.—Calculated total recoveries, by age of fish and type of mark, for fall chinook salmon of the 1961-64 broods that were marked and released at Columbia River hatcheries.

Brood and area	Spring Creek mark age (years)					Kalama mark age (years)					General mark age (years)				
	2	3	4	5	Total	2	3	4	5	Total	2	3	4	5	Total
1961															
Alaska	*	0	0	0	0	*	5	35	4	44	*	0	7	0	7
Brit. Col.	*	841	164	5	1,010	*	441	480	91	1,012	*	4,106	1,871	218	6,195
Wash. Com.	4	1,084	82	0	1,170	0	149	142	7	298	0	3,241	455	41	3,737
Wash. Sport	152	431	97	0	680	21	78	100	9	208	375	1,681	416	67	2,539
Oreg. Ocean	4	130	24	0	158	0	21	4	0	25	0	396	36	0	432
Col. River	22	518	685	17	1,242	0	38	399	111	548	72	2,158	3,544	176	5,950
Calif.	*	25	0	0	25	*	2	0	0	2	*	23	0	6	29
Total	182	3,029	1,052	22	4,285	21	734	1,160	222	2,137	447	11,605	6,329	508	18,889
1962															
Alaska	0	0	0	0	0	0	0	4	0	4	0	0	5	2	7
Brit. Col.	0	75	90	9	174	0	162	155	23	340	51	1,183	802	48	2,084
Wash. Com.	0	150	33	5	188	0	47	15	0	62	8	973	130	4	1,115
Wash. Sport	34	140	24	0	198	0	76	7	8	91	163	540	108	27	838
Oreg. Ocean	0	11	3	0	14	0	8	4	0	12	2	37	3	0	42
Col. River	10	272	85	0	367	6	21	60	10	97	50	1,216	606	24	1,896
Calif.	0	0	0	0	0	0	0	0	0	0	0	6	0	0	6
Total	44	648	235	14	941	6	314	245	41	606	274	3,955	1,654	105	5,988
1963															
Alaska	0	0	0	0	0	0	5	14	0	19	0	0	9	*	9
Brit. Col.	23	557	224	6	810	0	233	195	45	473	55	4,464	2,246	201	6,966
Wash. Com.	0	381	38	0	419	0	107	71	5	183	5	3,227	464	10	3,706
Wash. Sport	120	329	103	0	552	138	139	53	12	342	1,189	2,569	451	46	4,255
Oreg. Ocean	0	63	10	0	73	2	27	13	0	42	4	652	165	3	824
Col. River	29	164	275	15	483	7	32	44	47	130	121	1,182	2,418	317	4,038
Calif.	0	4	0	0	4	0	0	0	0	0	0	12	12	15	39
Total	172	1,498	650	21	2,341	147	543	390	109	1,189	1,374	12,106	5,765	592	19,837
1964															
Alaska	0	0	*	*	0	0	0	*	*	0	0	0	*	*	0
Brit. Col.	7	589	432	16	1,044	0	45	478	64	587	10	1,339	1,446	92	2,887
Wash. Com.	0	906	127	0	1,033	0	65	37	5	107	4	2,268	354	3	2,181
Wash. Sport	244	581	70	10	905	38	44	26	0	108	483	1,506	249	0	2,212
Oreg. Ocean	127	171	27	0	325	0	10	13	0	23	151	614	170	0	935
Col. River	15	447	504	24	990	0	3	58	56	117	19	1,001	1,204	169	2,393
Calif.	0	8	2	0	10	0	0	0	0	9	0	0	1	0	1
Total	393	2,702	1,162	50	4,307	38	176	612	125	951	667	6,728	3,424	266	11,085

* No sampling.

Columbia River fall chinook salmon. No single fin marks are included. These same data are depicted in Figures 2-4 for calculated numbers of marked fish recovered and in Figures 5-7 as percentages of the total number of marks recovered by each age group within each brood year.

More Spring Creek mark recoveries (Figure 2) were recovered as age 3 fish than at any other age. Both the age 2 and age 3 recoveries came principally from Washington State fisheries, whereas most of the age 4 and age 5 recoveries were from the British Columbia troll fishery and the Columbia River gillnet fishery. For all ages combined, Washington State fisheries had the most recoveries of Spring Creek fish with about equal numbers recovered in the British Columbia and Columbia River fisheries. From 18 to 35% of the total recoveries were made in British Columbia fisheries (Figure 5). No Spring Creek fish were recovered from the Alaska fisheries.

The recoveries of marked Kalama fish were distributed somewhat differently than marked Spring Creek fish (Figure 3). Although re-

coveries of marked 2-year-old fish occurred primarily in the Washington sport fishery, 3- and 4-year-old recoveries and the recoveries for all ages combined came principally from the British Columbia troll fishery. Most of the recoveries occurred with the 3- and 4-year-old fish. British Columbia fisheries had from 40% to 60% of the total recoveries (Figure 6), a considerably higher percentage than for Spring Creek fish. There were very few recoveries from the Alaska fisheries.

General mark recoveries seemed to be more similar to Spring Creek recoveries than to Kalama recoveries, indicating that most of the fish from the participating hatcheries had an ocean distribution and maturity schedule more like Spring Creek fish than Kalama fish. For the general mark recoveries, the 2-year-old recoveries were mainly from the Washington sport fishery (Figure 4). The Washington fisheries accounted for 38-53% of the 3-year-old mark recoveries, whereas both the 4- and 5-year-old recoveries came mainly from the British Columbia troll fishery and the Columbia River gill-

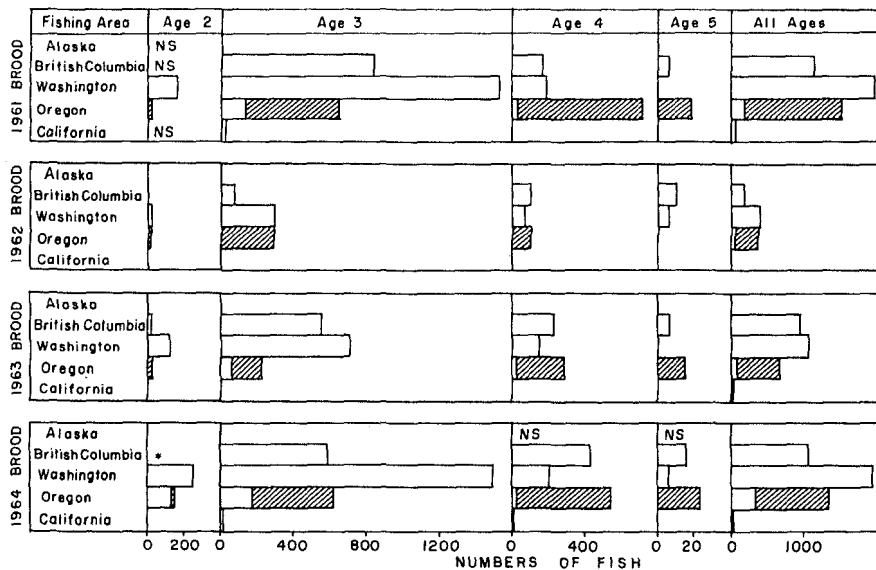

FIGURE 2.—Calculated total recoveries (in numbers of fish) of special marked Spring Creek hatchery fall chinook salmon, by age, in different fishing areas, 1961-64 brood years (Columbia River recoveries are shown as the shaded portion of the Oregon recoveries). NS = no sample; * = less than 10 recoveries.

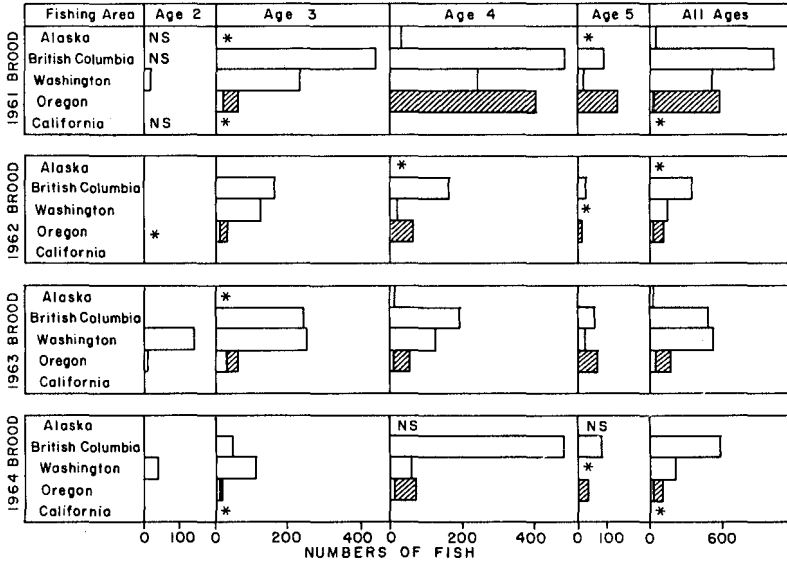

FIGURE 3.—Calculated total recoveries (in numbers of fish) of special marked Kalama hatchery fall chinook salmon, by age, in different fishing areas, 1961-64 brood years (Columbia River recoveries are shown as the shaded portion of the Oregon recoveries). NS = no sample; * = less than 10 recoveries.

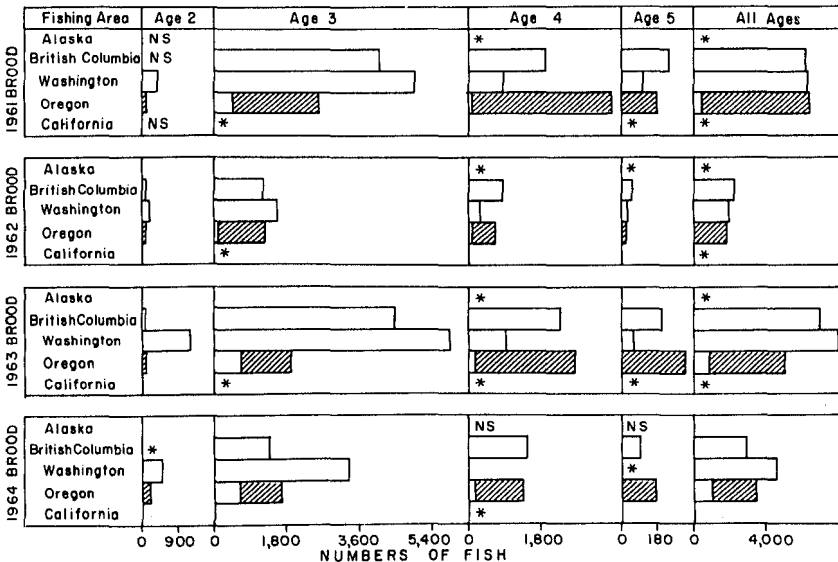

FIGURE 4.—Calculated total recoveries (in numbers of fish) of general marked Columbia River hatchery fall chinook salmon, by age, in different fishing areas, 1961-64 brood years (Columbia River recoveries are shown as the shaded portion of the Oregon recoveries). NS = no sample; * = less than 50 recoveries.

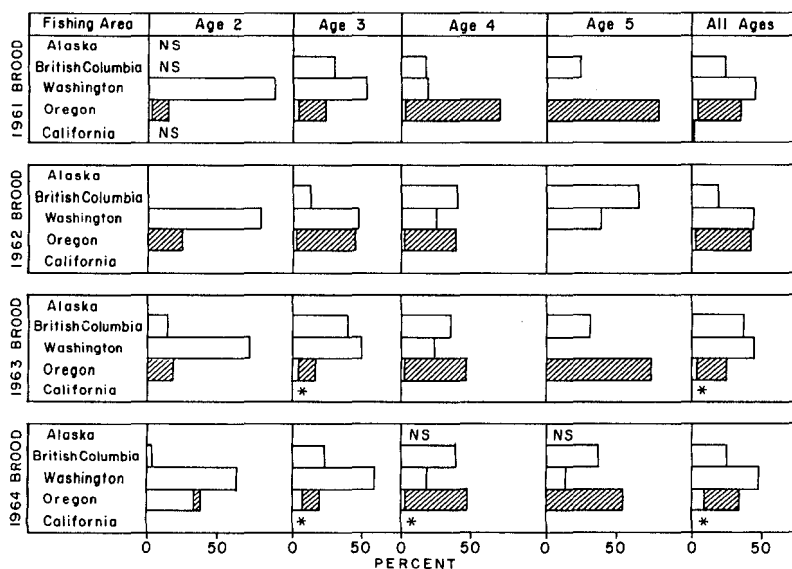

FIGURE 5.—Calculated total recoveries (in percent) of special marked Spring Creek hatchery fall chinook salmon, by age, in different fishing areas, 1961-64 brood years (Columbia River recoveries are shown as the shaded portion of the Oregon recoveries). NS = no sample; * = less than 1 percent.

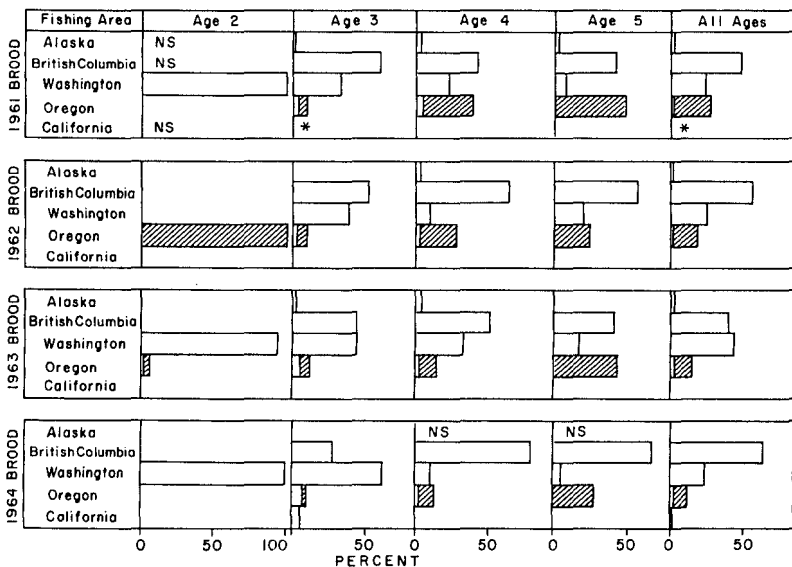

FIGURE 6.—Calculated total recoveries (in percent) of special marked Kalama hatchery fall chinook salmon, by age, in different fishing areas, 1961-64 brood years (Columbia River recoveries are shown as the shaded portion of the Oregon recoveries). NS = no sample; * = less than 1 percent.

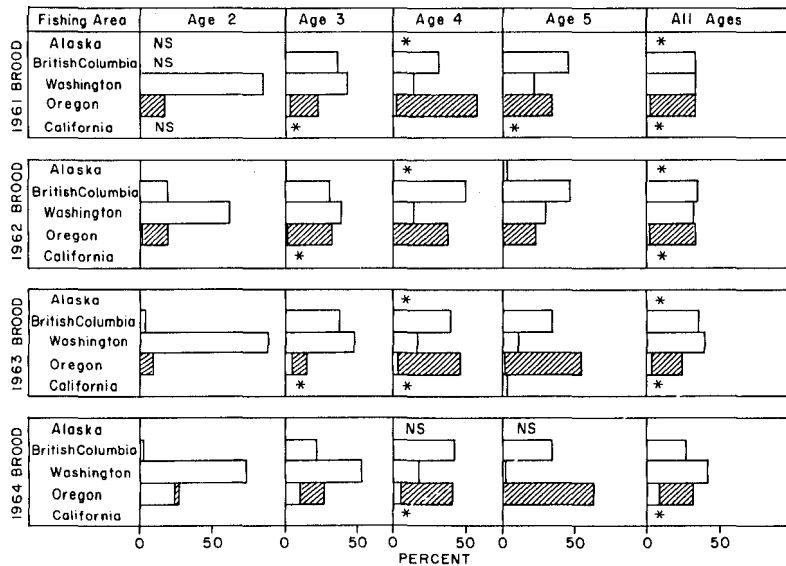

FIGURE 7.—Calculated total recoveries (in percent) of general marked Columbia River hatchery fall chinook salmon, by age, in different fishing areas, 1961-64 brood years (Columbia River recoveries are shown as the shaded portion of the Oregon recoveries). NS = no sample; * = less than 1 percent.

net fishery (Figure 7). For all ages combined, the recoveries were fairly equally distributed between the British Columbia, Washington, and Columbia River fisheries.

As mentioned above, the age at recovery for Kalama fall chinook salmon was somewhat different than the age at recovery of the other two groups of marked fish. This is more clearly seen in Figure 8 where the calculated total ocean recovery of special marked Spring Creek, Kalama, and general marked fish (by age) for these four brood years is shown. Thus, for Spring Creek most of the ocean recoveries were as 3-year-old fish (66-83%); Kalama mainly as 3- (21-57%) and 4-year-olds (32-66%); and general marks mainly as 3-year-olds (64-73%).

SIZE AND GROWTH

Not only were the recoveries by age and area different for Spring Creek and Kalama fall chinooks, but these fish also experienced different apparent growth patterns. In Figure 9 are shown the average weights, by age and sex, of marked Spring Creek and Kalama fish recovered in the Columbia River gillnet fishery. The Ka-

lama fall chinooks were generally smaller than the Spring Creek fish at ages 2-4, whereas the Kalama fish were larger at age 5. This change in the relative size of fish from these two stocks of salmon might reflect the selective effects of a more intensive troll fishery on the faster growing, earlier maturing Spring Creek fish, whereby the larger Spring Creek fish are more apt to be caught by the troll fishery at ages 2 and 3. Since data are limited for some of the sex-age categories, I have combined the data for all brood years and both sexes and have completed a von Bertalanffy type growth equation for these two stocks (Figure 10). The relatively faster growth at the younger ages and the more abrupt slowing down of growth at the older age is evident for the Spring Creek fish. Parameters calculated for Spring Creek were: $W_{\infty} = 12.76$ kg, $t_0 = 1.02$, and $k = 1.1$; for Kalama they were: $W_{\infty} = 18.44$ kg, $t_0 = 0.77$, and $k = 0.6$. These growth parameters clearly detail the growth differences between these two stocks and would be useful in any future dynamic pool type of analysis (Beverton and Holt, 1957) of potential production from them.

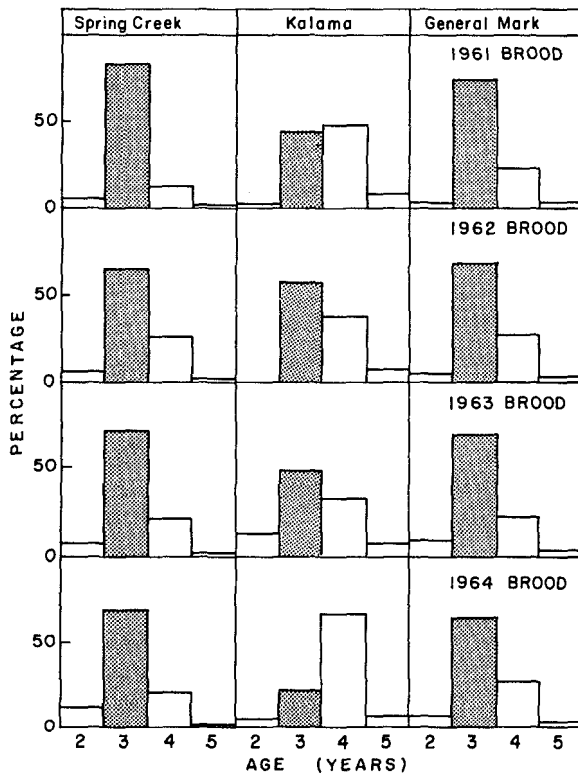

FIGURE 8.—Calculated total ocean recoveries (in percent), by age, of special marked Spring Creek, Kalama, and general marked Columbia River hatchery fall chinook salmon, 1961-64 brood years.

GRAPHIC POPULATION MODEL FOR COLUMBIA RIVER FALL CHINOOK

To more clearly understand all the forces affecting a stock of fish, it often is convenient to depict the population in a simulated flow chart or block diagram. Shapiro and Andreev (1969) show such a diagram for chum salmon (*O. keta*). With some modification, their diagram also would be applicable to Columbia River fall chinook salmon as shown in Figure 11. This diagram is based on the following stock characteristics. There are five age groups, four of which are capable of entering the spawning groups, and each brood year diminishes in numbers as

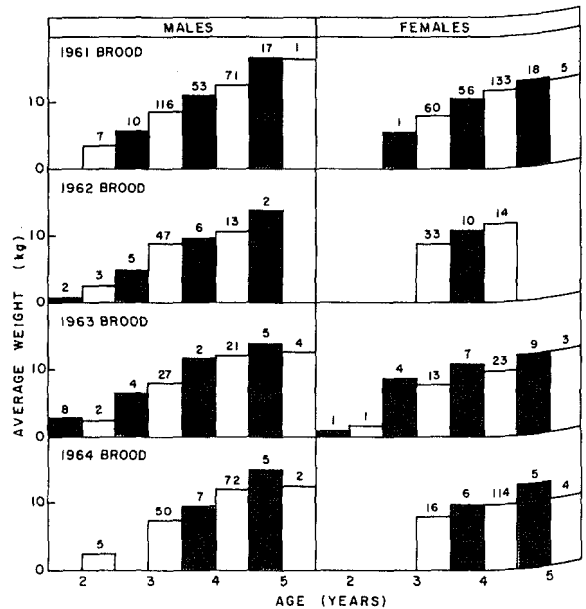

FIGURE 9.—Average weight (kilograms) by age and sex, of 1961-64 brood Spring Creek and Kalama special marked hatchery fall chinook salmon caught in the Columbia River gillnet fishery. Shaded columns represent data for Kalama salmon — clear columns, Spring Creek. Numbers indicate sample size.

a result of natural mortality (M_i) and ocean fishing mortality (F_i). Ocean fishing mortality occurs only on the 2+, 3+, and 4+-year-old fish. Growth and fecundity differ for each age group, and entry into the spawning part of the population is affected by a probability (P_i). The spawning group is diminished by a river fishing mortality (RF_i). After river fishing mortality, some portion of the spawning fish (k_i) are removed for artificial propagation. Survivals to recruitment resulting from artificial and natural reproduction are taken to be different. The number of recruits (R) is dependent on a survival relationship for the effective fecundity, i.e., R/E .

EFFECT OF TROLL FISHING ON YIELD

A complete analysis of the Columbia River fall chinook population, as depicted in Figure 11, is beyond the scope of this paper. However, 1

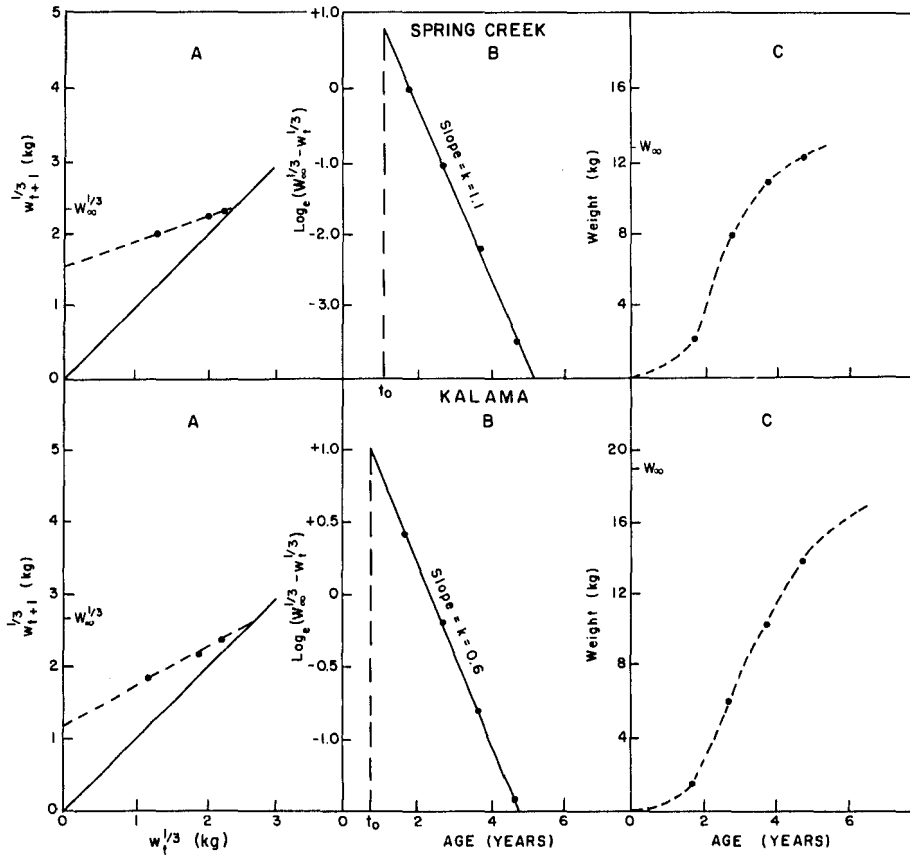

Figure 10.—Successive stages of fitting Spring Creek and Kalama Hatchery fall chinook salmon weight data from Figure 8 to the von Bertalanffy growth equation. Part A shows the relation between average weight at age t and age $t + 1$ — point on the dotted line where $w_t^{1/3} = w_{t+1}^{1/3}$ is an estimate of $W_\infty^{1/3}$. Part B shows the relation between age and a logarithmic function of the weight used to estimate the value of k (i.e., the slope). Part C shows the calculated growth curve based on the values computed from Parts A and B.

want to analyze a part of the model, the part dealing with the ocean and river fisheries, to show the calculated effect the troll fishery has on total yield for a particular brood year. In these analyses, I have used data developed for the 1961 and 1962 brood years for the Spring Creek and Kalama fall chinooks, based on studies by Cleaver (1969) and Henry (1971), respectively. Where there were some data missing for the 1962 brood Spring Creek fish, I used 1961 data. The starting point for the analyses is at age 1+ in Figure 11.

It is apparent from Figure 11 that given F_i , M_i , P_i , and RF_i , as well as data on average weights of fish at each age, total yields from the ocean and river fisheries for a given number of recruits (R) can be calculated. Henry (1971) gives estimates of F_i and P_i for various values of M_i as well as values for RF_i for 1961 brood Spring Creek and Kalama fish and 1962 brood Kalama fish. Lack of river recoveries of 5-year-old fish prevented estimates of these values for 1962 brood Spring Creek chinook salmon. Henry also lists average weight data, by age, for both

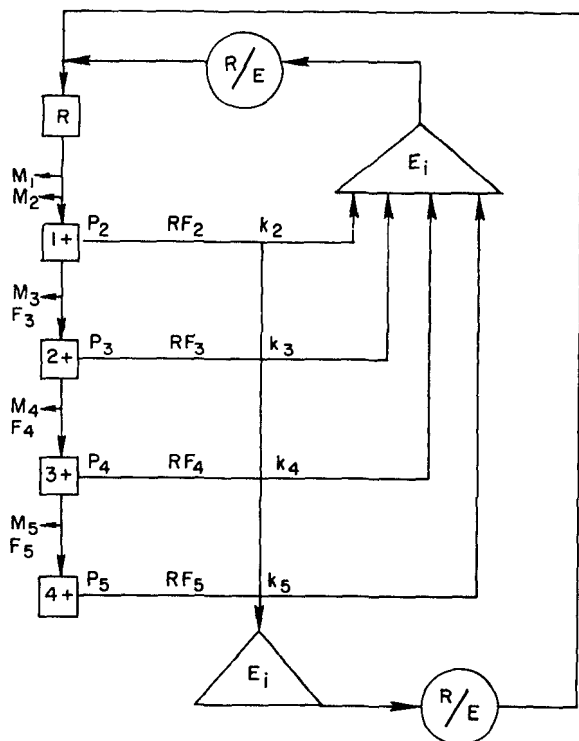

FIGURE 11.—Block diagram of a population model for Columbia River fall chinook salmon (adapted from Shapiro and Andreev, 1969).

- M_i = natural mortality rate.
 F_i = ocean fishing mortality rate.
 RF_i = river fishing mortality rate.
 P_i = probability of being a spawner.
 k_i = percentage of spawners taken for artificial reproduction.
 E_i = effective fecundity/1,000 eggs.
 R = number of recruits.
 1+, 2+, 3+, 4+ = age of fish.

the ocean and river recoveries of these two stocks of fish.

The procedures followed in these analyses were: given a certain number of recruits (1,000) and a certain M_i (natural mortality) value, and assuming $M_2 = M_3 = M_4$, I calculated the total yield for all ages (numbers caught \times average weight) from both the ocean and river fisheries using the P_i values (where P_i is the proportion of the ocean population entering the river to spawn) for the M_i as given by Henry (1971). I let the P_i and RF_i values (where

RF_i is the river fishing mortality) remain constant but varied the F_i 's (where F_i is the ocean fishing mortality) from 0 to 1.8. This procedure resulted in a 3-dimensional yield diagram (i.e., F_3 , F_4 , and F_5). The computations were done on an IBM 1130⁴ computer and I wrote the program so the computed yields were plotted directly in even yield planes by a CalComp plotter.

Regardless of the natural mortality rate assumed for these computations, it appears that total yields under actual conditions were below the potential yields for both Spring Creek and Kalama fall chinook. In Figure 12 are depicted the calculated maximum potential yields for various values of natural mortality (M_i) and the ocean fishing values (F_i) needed to achieve these maximum yields as well as the calculated yields based on estimated fishing mortality rates for various values of M as given by Henry (1971). It is only with the higher levels of natural mortality (>0.60) or with the 1962 brood Spring Creek fish that a troll fishery on the 3-year-olds (F_3) would have increased yield. At all levels of natural mortality shown, maximum yield required maximum troll fishing effort on the 5-year-old fish (F_5).

The calculated total yield varied considerably depending on the F and M values used. The 3-dimensional outputs for $M = 0.24$ and $F_i = 0$ to 1.8 for the two hatcheries for the 1961 brood year are shown in Figures 13 and 14. I have included a yield diagram for each stock to show the differences in yield that can be generated in this type of analysis as well as to emphasize the differences between these two groups of salmon. The calculated yield planes shown in these figures are actually planes of equal yield passing through the block diagrams. Each yield plane shown consists of points that represent all possible combinations of ocean fishing mortality (F_3 , F_4 , and F_5)—such that total yield will equal the value shown. In Figure 13, for 1961 brood Spring Creek fish ($M = 0.24$), the maximum yield is at point A ($F_3 = 0$, $F_4 = 0$, and $F_5 = 1.8$) and is slightly over 6,300, the same value as shown in Figure 12. Yield diagrams calculated for $M = 0.96$ were similar to

⁴ Use of trade names does not imply endorsement by the National Marine Fisheries Service.

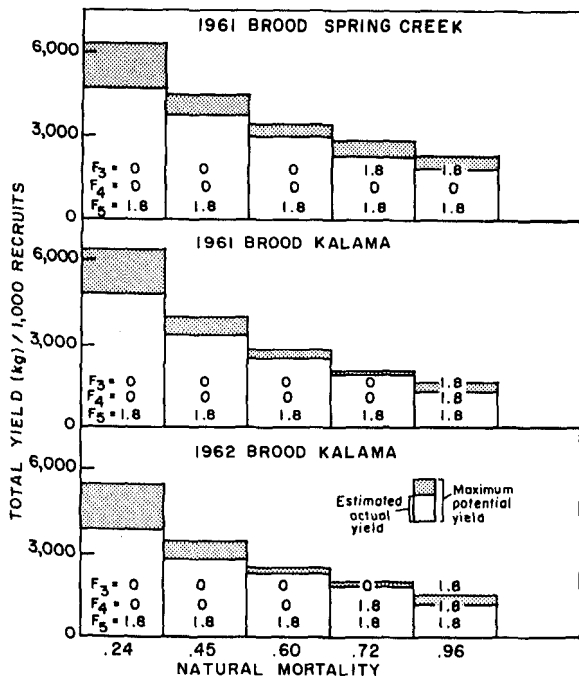

FIGURE 12.—Calculated maximum potential yields (kilograms) per 1,000 recruits for the 1961 brood Spring Creek and Kalama and the 1962 brood Kalama hatchery fall chinook salmon compared with yields calculated for estimated rates of actual ocean fishing mortality (F values shown are those producing maximum potential yields).

those shown except that they depicted lower yields, as would be expected with a higher natural mortality. Similar analyses also were made from the 1962 brood data, but those yield diagrams are not depicted.

In a similar manner to that shown for obtaining the maximum yield, the calculated total yield for any combination of F_3 , F_4 , and F_5 could be estimated from these graphs. However, the purpose of these graphs is not to estimate single yield values but rather to show the overall effect on yield of varying values of F_3 , F_4 , and F_5 . Thus, Figure 13 shows that the total yields diminish as F_3 and F_4 increase but that F_5 has little effect on total yield. Under these conditions, any troll fishing on 3- and 4-year-old fish would reduce the total yield.

It might be well to re-emphasize that these calculations are based on the assumption of a

constant M for the period analyzed. Variations in M during this period would, of course, affect the calculated total yield depending on when the variations occurred and their magnitude. However, a differential M before entry into the troll fishery, i.e., at age 2 and younger, would not affect this analysis.

There is considerable variation in the two yield diagrams, and the reader will have to examine each figure to see in detail the effect of varying levels of troll fishing for that particular brood and level of natural mortality. In general, at the lower levels of natural mortality ($M = 0.24$), increased troll fishing on the younger age group (2+ and 3+) results in reduced yields, whereas the reverse of this generally occurs at the higher level of natural mortality ($M = 0.96$). In other words, at the younger ages and the lower natural mortalities it appears that the rate of growth exceeds the loss due to natural mortality and, consequently, yield is increased by letting the salmon reach an older age before harvesting them. It should be pointed out that even if no fish had been caught in the ocean, the number returning to the river would have been less than the sum of river entry and ocean catch since some of the fish caught in the ocean fishery would have died from natural causes.

The values of M and F that I used, although arbitrary, are believed to cover the range of realistic possible values. Obviously, any values of M could be inserted into the program, but it was felt that $M = 0.24$ and $M = 0.96$ would depict extremes. Also, F_i values greater than 1.8 could be used, but I arbitrarily limited them at this upper boundary because F values of 1.8 considerably exceed any of the F values calculated for either the 1961 or 1962 brood data (Henry, 1971).

The calculated total yields for 1961 and 1962 brood Spring Creek and Kalama fall chinook salmon for various values of natural mortality—if troll fishing could be restricted to only one age group; i.e., troll fishing on only the 3-, 4-, or 5-year-old fish—are shown in Figures 15 and 16. The values for river fishing intensity and proportion spawning are the same as used in the previous analyses. The yields shown are the

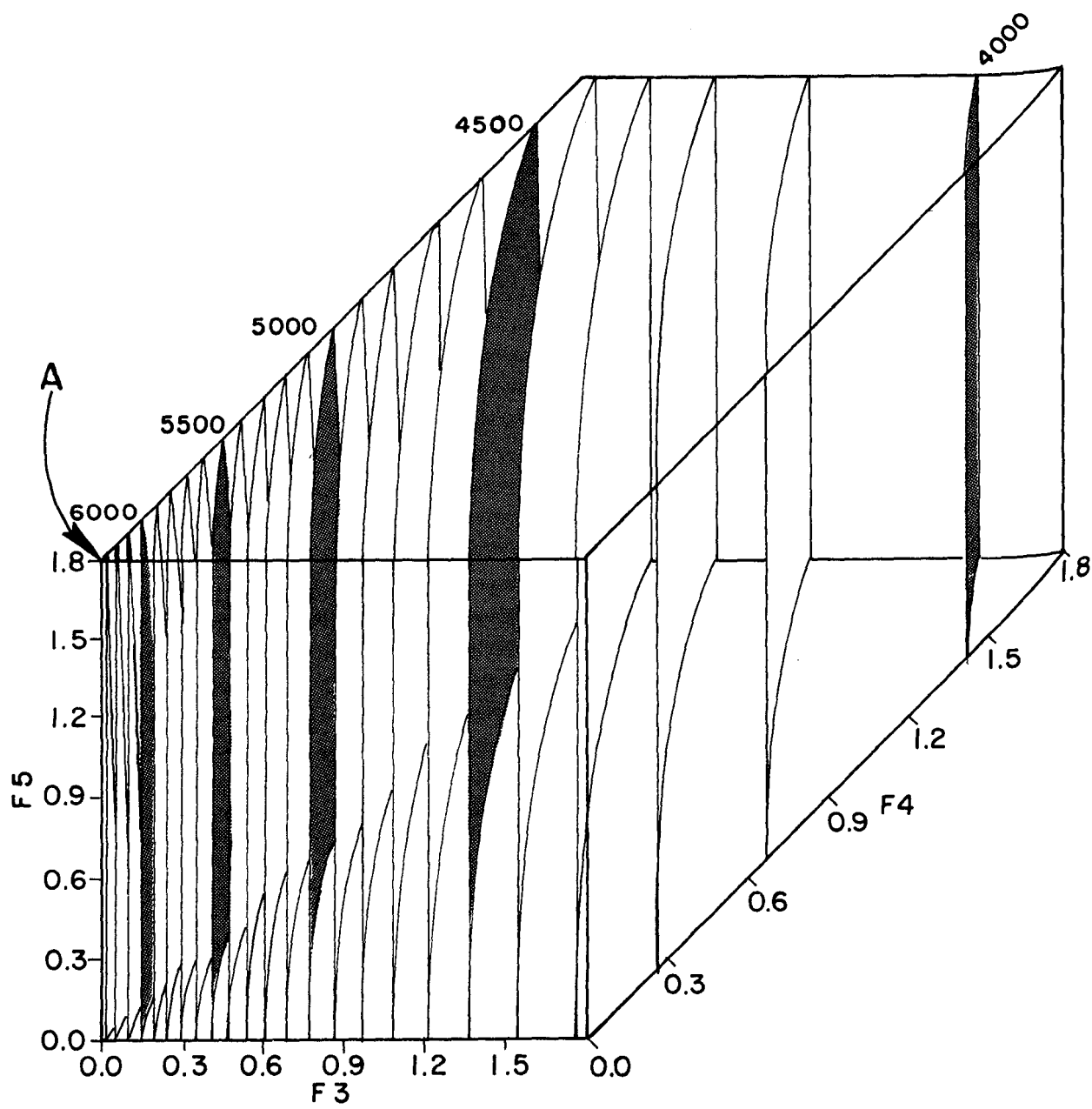

FIGURE 13.—Calculated total yield diagrams (in kilograms per 1,000 recruits) for the 1961 brood Spring Creek hatchery fall chinook salmon with constant natural mortality ($M = 0.24$), varying ocean troll fishing mortality rates (F_3 , F_4 , and F_5), and the proportion spawning and river fishing intensity remaining constant. Yields are shown by 100-kilogram plane intervals.

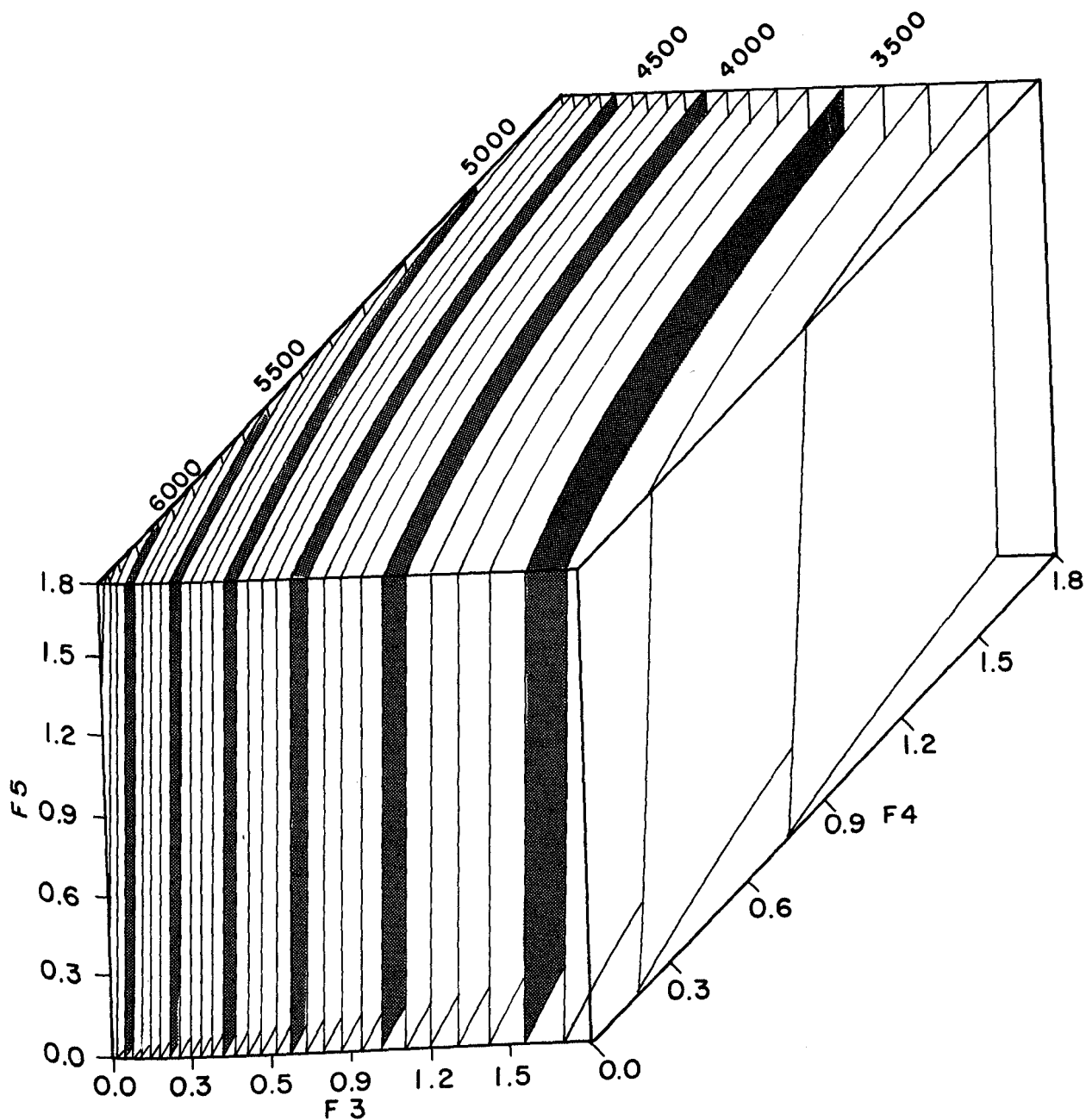

FIGURE 14.—Calculated total yield diagrams (in kilograms per 1,000 recruits) for the 1961 brood Kalama hatchery fall chinook salmon with constant natural mortality ($M = 0.24$), varying ocean troll fishing mortality rates (F_3 , F_4 , and F_5), and the proportion spawning and river fishing intensity remaining constant. Yields are shown by 100-kilogram plane intervals.

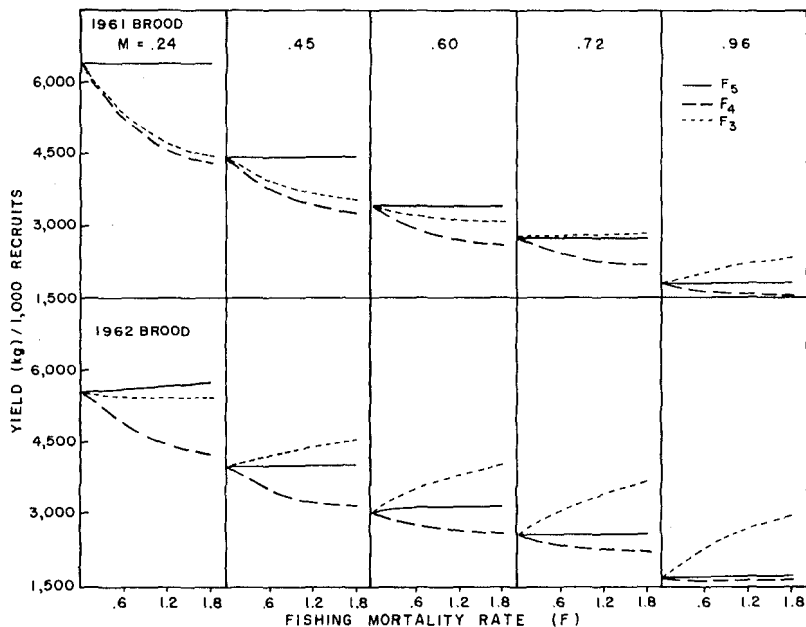

FIGURE 15.—Calculated total yields (in kilograms) for 1961 and 1962 brood Spring Creek hatchery fall chinook salmon for different natural mortality rates and fishing on only one age group at a time.

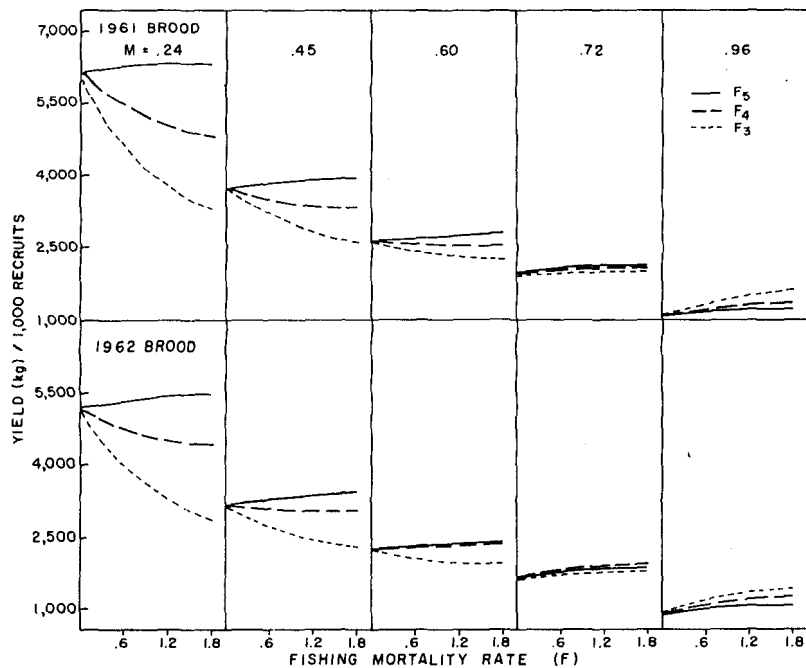

FIGURE 16.—Calculated total yields (in kilograms) for 1961 and 1962 brood Kalama hatchery fall chinook salmon for different natural mortality rates and fishing on only one age group at a time.

same as would be observed by reading along the F_3 , F_4 , and F_5 axes in Figures 13 and 14. It is apparent from these data that at any level of natural mortality (M_i), as fishing mortality is increased on the 5-year-old fish (F_5) (with F_3 and $F_4 = 0$), total yield increases, although slightly. For the Spring Creek data (Figure 15), any increase in F_4 , with the other two F values = 0, would result in reduced yield. For Kalama fish (Figure 16), for both broods at $M = 0.72$ and higher, total yield would increase with an increase in any of the F values. In general, troll fishing on the age 3 and age 4 Spring Creek and Kalama fall chinook salmon tends to reduce total yield for M_i values less than 0.82, except for the 1962 brood Spring Creek fish. For these fish it appears that growth was insufficient to compensate for natural mortality losses of 4-year-old fish, even at a natural mortality rate of $M = 0.45$. Thus, yield was increased by harvesting them as 3-year-olds in the troll fishery (F_3).

LITERATURE CITED

- BEVERTON, R. J. H., AND S. J. HOLT.
1957. On the dynamics of exploited fish populations. Fish. Invest. Min. Agr. Fish. Food (Gt. Brit.), Ser. II 19, 553 p.
- CLEAVER, F. C.
1969. Effects of ocean fishing on 1961-brood fall chinook salmon from Columbia River hatcheries. Fish Comm. Oreg., Res. Rep. 1(1). 76 p.
- HENRY, K. A.
1971. Estimates of maturation and ocean mortality based on marked 1962-brood Columbia River chinook salmon and effect of ocean fishing on the total stock. Fish. Comm. Oreg., Res. Rep. 3:13-27.
- LANDER, R. H.
1970. Distribution in marine fisheries of marked chinook salmon from the Columbia River Hatchery Program, 1963-66. Fish Comm. Oreg., Res. Rep. 2(1):28-55.
- PULFORD, E. F.
1970. Estimated contribution of Columbia River hatchery fall chinook salmon to sport and commercial fisheries in 1966. Fish Comm. Oreg., Res. Rep. 2(1):3-14.
- SHAPIRO, A. P., AND V. L. ANDREEV.
1969. Optimal'noe sootnoshenie mezhdru iskusstvennyim i estestvennyim vosproizvodstvom oblavlivayemoy populyatsii ryb (Optimum relationship between artificial and natural reproduction for commercial populations of fishes). Vopr. Ikhtiol. 9(1):61-67. (Transl. in Probl. Ichthyol., 1970, 9(1):45-49, issued by Am. Fish. Soc.).
- WORLUND, D. D., R. J. WAHLE, AND P. D. ZIMMER.
1969. Contribution of Columbia River hatcheries to harvest of fall chinook salmon (*Oncorhynchus tshawytscha*). U.S. Fish Wildl. Serv., Fish. Bull. 67:361-391.